

CMM cable guide

www.renishaw.com

CMM cable guide

Documentation part number: H-1000-4053-19-A

CMM cable guide

www.renishaw.com

CMM cables general information

© 2004 - 2024 Renishaw plc. All rights reserved.

This document may not be copied or reproduced in whole or in part, or transferred to any other media or language by any means, without the prior written permission of Renishaw.

Disclaimer

WHILE CONSIDERABLE EFFORT WAS MADE TO VERIFY THE ACCURACY OF THIS DOCUMENT AT PUBLICATION, ALL WARRANTIES, CONDITIONS, REPRESENTATIONS AND LIABILITY, HOWSOEVER ARISING, ARE EXCLUDED TO THE EXTENT PERMITTED BY LAW.

RENISHAW RESERVES THE RIGHT TO MAKE CHANGES TO THIS DOCUMENT AND TO THE EQUIPMENT, AND/OR SOFTWARE AND THE SPECIFICATION DESCRIBED HEREIN WITHOUT OBLIGATION TO PROVIDE NOTICE OF SUCH CHANGES.

Trade marks

RENISHAW®, the probe symbol and REVO® are registered trade marks of Renishaw plc.

Renishaw product names, designations and the mark 'apply innovation' are trade marks of Renishaw plc or its subsidiaries.

Other brand, product or company names are trade marks of their respective owners.

WEEE



The use of this symbol on Renishaw products and / or accompanying documentation indicates that the product should not be mixed with general household waste upon disposal. It is the responsibility of the end user to dispose of this product at a designated collection point for waste electrical and electronic equipment (WEEE) to enable reuse or recycling. Correct disposal of this product will help to save valuable resources and prevent potential negative effects on the environment. For more information, please contact your local waste disposal service or Renishaw distributor.

Warranty

Unless you and Renishaw have agreed and signed a separate written agreement, the equipment and/or software are sold subject to the Renishaw Standard Terms and Conditions supplied with such equipment and/or software, or available on request from your local Renishaw office.

Renishaw warrants its equipment and software for a limited period (as set out in the Standard Terms and Conditions), provided that they are installed and used exactly as defined in associated Renishaw documentation. You should consult these Standard Terms and Conditions to find out the full details of your warranty.

Equipment and/or software purchased by you from a third-party supplier is subject to separate terms and conditions supplied with such equipment and/or software. You should contact your third-party supplier for details.

CMM cable guide

www.renishaw.com

Care of equipment

Renishaw probes and associated systems are precision tools used for obtaining precise measurements and must therefore be treated with care.

Changes to Renishaw products

Renishaw reserves the right to improve, change or modify its hardware or software without incurring any obligations to make changes to Renishaw equipment previously sold.

Company registration details

Renishaw plc. Registered in England and Wales. Company no: 1106260. Registered office: New Mills, Wotton-under-Edge, Gloucestershire, GL12 8JR, UK.

CMM cable guide

www.renishaw.com

CMM cables product compliance

EU declaration of conformity

Contact Renishaw plc or visit www.renishaw.com/EUCMM for the full EU declaration.

UK declaration of conformity

Contact Renishaw plc or visit www.renishaw.com/UKCMM for the full UK declaration.

REACH regulation

Information required by Article 33(1) of Regulation (EC) No. 1907/2006 ("REACH") relating to products containing substances of very high concern (SVHCs) is available at:

www.renishaw.com/REACH

China RoHS

Contact Renishaw plc or visit www.renishaw.com/ChinaRoHSCMM for the full China RoHS tabulation.

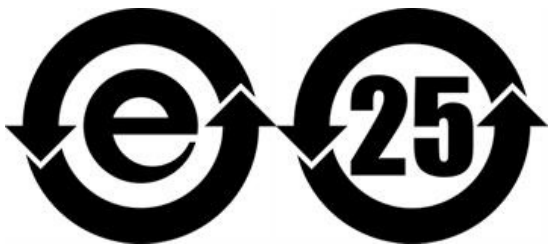

CMM cables warnings

In all applications involving the use of machine tools or co-ordinate measuring machines (CMMs) eye protection is recommended.

There are no user serviceable parts inside Renishaw's main powered units. Return defective units to an authorised Renishaw Customer Service Centre.

Replace blown fuses with new components of the same type. Refer to the SAFETY section of the relevant product documentation.

For instructions regarding the safe cleaning of Renishaw products refer to the MAINTENANCE section of the relevant product documentation.

Remove power before performing any maintenance operations.

Always allow sufficient time for electrical charge to dissipate from electrical components before handling.

Observe anti-static handling precautions, including the use of earth straps with plug-in cards.

Refer to the machine supplier's operating instructions.

It is the machine supplier's responsibility to ensure that the user is made aware of any hazards involved in operation, including those mentioned in Renishaw product documentation, and to ensure that adequate guards and safety interlocks are provided.

Under certain circumstances the probe signal may falsely indicate a probe seated condition.

Do not rely on probe signals to stop machine movement.

The expected method of providing an emergency stop for Renishaw products is to remove power.

CMM cable guide

www.renishaw.com

CMM cables introduction

This guide contains comprehensive information on the most commonly used Renishaw cables.

It is of particular use to engineers involved in installation or support of Renishaw equipment on CMMs, or where correct cable identification is required.

Further information for signals, connectors and switch settings of controllers and interfaces can be found in the CMM products switch setting and connector guide (Renishaw part number H-1000-4068) or relevant installation and user's guides.

Renishaw cables are identified by marker rings or printing to show the 'PL' number.

These markers have a T,V or U suffix to reflect the cable function and design.

Further customised cable solutions are available for specific applications, please contact Renishaw for further details.

CMM product support

Renishaw provides comprehensive world-wide sales and technical support through an extensive network of locally staffed subsidiary offices and regional service and repair centres, contact us at www.renishaw.com/contact.

CMM cable guide

www.renishaw.com

Cable information quick reference tables

Manual probe head cables

PL no.	Length	Connectors	Connectors	Part number	Page
PL1	260 mm to 710 mm (10.24 in to 27.95 in)	In-line 5-pin DIN plug	90° moulded plastic 5-pin DIN plug	A-1016-0004	13
PL2	410 mm to 1.27 m (16.14 in to 50 in)	In-line 5-pin DIN plug	90° moulded plastic 5-pin DIN plug	A-1016-0006	13
PL3	680 mm to 2.32 m (26.77 in to 91.34 in)	In-line 5-pin DIN plug	90° moulded plastic 5-pin DIN plug	A-1016-0012	13
PL4	4.5 m (177.17 in)	In-line 5-pin DIN plug	90° moulded plastic 5-pin DIN plug	A-1016-0001	14
PL14	590 mm to 1.83 m (23.23 in to 72.05 in)	7-pin Amphenol plug	90° moulded plastic 5-pin DIN plug	A-1016-0003	21
PL17	160 mm to 260 mm (6.3 in to 10.24 in)	90° moulded 5-pin DIN plug	In-line LEMO plug	A-1023-7024	23
PL18	560 mm to 1.06 m (22.05 in to 41.73 in)	90° moulded 5-pin DIN plug	In-line LEMO plug	A-1023-7025	23
PL27	225 mm to 450 mm (8.86 in to 17.72 in)	90° moulded 5-pin DIN plug	90° moulded 5-pin DIN plug	A-1016-6370	29
PL52	275 mm to 550 mm (10.83 in to 21.65 in)	5-pin Franz Binder plug	Moulded 90° 5-pin DIN plug	A-1016-6500	36
-	160 mm (6.3 in)	90° moulded 5-pin DIN plug	90° moulded 5-pin DIN plug	A-1016-6440	12

Motorised probe head cables

PL no.	Length	Connectors	Connectors	Part number	Page
PL5	400 mm to 800 mm (15.75 in to 31.5 in)	In-line LEMO plug	90° Tuchel socket	A-1016-7672	15
PL6	800 mm to 1.6 m (61.5 in to 62.99 in)	In-line LEMO plug	90° Tuchel socket	A-1016-7673	15
PL12	100 mm (3.94 in)	In-line LEMO plug	90° Tuchel socket	A-1016-7674	19
PL13	100 mm to 200 mm (3.94 in to 7.87 in)	In-line LEMO plug	90° Tuchel socket	A-1016-7675	15
PL33	3 m (118.11 in)	In-line LEMO socket or plug	90° Tuchel socket	A-1023-7056	32
PL93	100 mm (3.94 in)	In-line LEMO plug	In-line Tuchel socket	A-1016-7676	44

CMM cable guide

www.renishaw.com

SP80 cables

PL no.	Length	Connectors	Connectors	Part number	Page
PL156	60 mm (23.62 in)	26-pin high-density D-type socket	Unterminated	A-1016-7129	55
PL157	230 mm (9.06 in)	15-pin high-density D-type socket	In-line 14-pin LEMO plug	A-1016-7132	57
PL158	1 m (39.37 in)	26-pin high-density D-type socket	26-pin D-type plug	A-1016-7133	58

Machine cables

PL no.	Length	Connectors	Connectors	Part number	Page
PLM6	6 m (236.22 in)	15-pin D-type plug	14-pin chassis-mount LEMO socket (supplied loose)	A-1016-7564	63
PLM7	4 m (157.48 in)	15-pin D-type plug	14-pin chassis-mount LEMO socket (supplied loose)	A-1016-7563	63
PLM8	6 m (236.22 in)	15-pin D-type plug	14-pin in-line LEMO socket	A-1016-7677	65
PLM9	4 m (157.48 in)	15-pin D-type plug	14-pin in-line LEMO socket	A-1016-7678	65

Output cables

PL no.	Length	Connectors	Connectors	Part number	Page
PL7T	3.1 m (122.1 in)	5-pin DIN socket	5-pin DIN socket	A-1029-0166	17
PL15	4.5 m (177.17 in)	In-line 5-pin DIN plug	Unterminated	A-1004-0110	22
PL26	600 mm (23.62 in)	9-pin D-type plug	7-pin DIN plug	A-1057-0132	28
PL37	500 mm (19.69 in)	In-line 7-pin DIN plug	In-line 7-pin DIN plug	A-1054-0003	34
PL101	500 mm (19.69 in)	15-pin high-density D-type socket	15-pin high-density D-type plug	A-1016-7662	47
	50 cm (19.7 in)	25-pin D-type socket	9-pin D-type socket	A-5567-1622	72

CMM cable guide

www.renishaw.com

Adaptor / extension cables - multiwire

PL no.	Length	Connectors	Connectors	Part number	Page
PL38V	25 m (984.25 in)	90° micro-D plug	15-pin high-density D-type plug	A-1016-7625	35
PL42V	15 m (590.55 in)	90° micro-D plug	15-pin high-density D-type plug	A-1016-7624	35
PL44V	8 m (314.96 in)	90° micro-D plug	15-pin high-density D-type plug	A-1016-7627	35
PL45V	1.9 m (74.8 in)	90° micro-D plug	15-pin high-density D-type plug	A-1016-7629	35
PL46V	3.7 m (145.67 in)	90° micro-D plug	15-pin high-density D-type plug	A-1016-7628	35
PL56V	12 m (472.44 in)	90° micro-D plug	15-pin high-density D-type plug	A-1016-7626	35
PL75V	1 m (39.37 in)	15-pin high-density D-type socket	15-pin high-density D-type plug	A-1016-7644	38

Adaptor / extension cables

PL no.	Length	Connectors	Connectors	Part number	Page
PL10	100 mm (3.94 in)	In-line LEMO plug	5-pin DIN socket	A-1029-0111	18
PL22	300 mm (11.81 in)	5-pin DIN socket	9-pin D-type plug	A-1057-0131	26
PL69V	10.5 m (413.39 in)	15-pin high-density D-type socket	15-pin high-density D-type plug	A-1016-7640	38
PL97	260 mm (10.24 in)	In-line 6-pin mini DIN socket	In-line 6-pin mini DIN plug	A-1016-7660	46
	260 mm (10.24 in)	15-pin D-type socket	15-pin high-density D-type plug	A-1333-0183	71
	230 cm (90.6 in) / 140 cm (55.1 in)			A-3065-0150	82
	510 cm (200.79 in)			A-3065-0160	83

CMM cable guide

www.renishaw.com

PICS interconnection cables

PL no.	Length	Connectors	Connectors	Part number	Page
PL24	5 m (196.85 in)	9-pin D-type socket	9-pin D-type plug	A-1016-0121	27
PL25	300 mm (11.81 in)	9-pin D-type socket	9-pin D-type plug	A-1016-0120	27
PL70T	400 mm (15.75 in)	9-pin D-type plug	15-pin high-density D-type socket	A-1016-7634	39
PL72T	2 m (78.7 in)	9-pin D-type socket	9-pin D-type plug	A-1016-7637	27
PL76T	1 m (39.37 in)	9-pin D-type socket	9-pin D type socket	A-1016-7643	41
PL172	48 cm to 52 cm (18.9 in to 20.5 in)	7-pin DIN plug	15-pin high-density	A-5684-1000	61

Controller cables

PL no.	Length	Connectors	Connectors	Part number	Page
	30 cm (11.8 in)			A-5629-0071	81
	50 cm (19.7 in)	5-pin D-type plug	9-pin D-type socket	A-5629-0090	73
PL163	5 m (196.85 in)	9-pin D-type socket	9-pin D-type plug	A-1016-8098	60
PL164	10 m (393.7 in)	9-pin D-type socket	9-pin D-type plug	A-1016-8099	60
PL171	15 m (590.55 in)	9-pin D-type socket	9-pin D-type plug	A-1016-8100	60
	97 cm (38.2 in)	25-pin D-type plug	9-pin D-type plug	A-5208-0011	75
	750 mm (29.53 in)	9-pin D-type plug	25-pin D-type plug	A-5121-0062	67

Rack cables

PL no.	Length	Connectors	Connectors	Part number	Page
PL19	5 m (196.85 in)	In-line 25-pin D-type socket	25-pin D-type plug	A-1051-0199	24
PL20	10 m (393.7 in)	In-line 25-pin D-type socket	25-pin D-type plug	A-1051-0045	24
PL21	15 m (590.55 in)	In-line 25-pin D-type socket	25-pin D-type plug	A-1051-0102	24
PL40	30 m (1181.1 in)	In-line 25-pin D-type socket	25-pin D-type plug	A-1054-0002	24

CMM cable guide

www.renishaw.com

SCR200 cables

PL no.	Length	Connectors	Connectors	Part number	Page
PL63	5 m (196.85 in)	In-line 6-pin mini DIN plug	In-line 6-pin mini DIN plug	A-1016-7630	37
PL64	10 m (393.7 in)	In-line 6-pin mini DIN plug	In-line 6-pin mini DIN plug	A-1016-7631	37
PL65	20 m (787.4 in)	In-line 6-pin mini DIN plug	In-line 6-pin mini DIN plug	A-1016-7632	37

Probe cables

PL no.	Length	Connectors	Connectors	Part number	Page
PL29	740 mm to 1.48 m (29.13 in to 58.27 in)	90° moulded 5-pin DIN plug	90° moulded 5-pin DIN plug	A-1016-6420	29
PL28	275mm to 550 mm (10.83 in to 21.65 in)	5-pin Franz Binder plug	Moulded 90° 5-pin DIN plug	A-1016-6386	30
PL31	300 mm to 600 mm (11.81 in to 23.62 in)	90° moulded 5-pin DIN plug	In-line LEMO plug	A-1049-8025	31
PL82V	5 m (196.85 in)	12-pin round Hirose-type plug	15-pin high-density D-type plug	A-1016-7648	42

PH20 and REVO cables

PL no.	Length	Connectors	Connectors	Part number	Page
	10 m (393.7 in)	15-pin D-type plug	15-pin D-type socket	A-5669-0090	76
	15 m (590.6 in)	15-pin D-type plug	15-pin D-type socket	A-5669-0091	76
	20 m (787.4 in)	15-pin D-type plug	15-pin D-type socket	A-5669-0092	76
	25 m (984.3 in)	15-pin D-type plug	15-pin D-type socket	A-5669-0093	76
	15 m (590.1 in)	15-pin D-type plug	15-pin D-type socket	A-5669-0015	78
	25 m (984.3 in)	15-pin D-type plug	15-pin D-type socket	A-5759-0025	78

CMM cable guide

www.renishaw.com

PHS1 accessories

PL no.	Length	Connectors	Connectors	Part number	Page
PL104	30 m (1181.1 in)	15-pin high-density D-type socket	Unterminated	A-2150-0481	48
PL105	30 m (1181.1 in)	15-pin high-density D-type socket	Unterminated	A-2150-0482	49
PL106	30 m (1181.1 in)	15-pin high-density D-type socket	Unterminated	A-2150-0483	50
PL107	30 m (1181.1 in)	15-pin high-density D-type socket	Unterminated	A-2150-0484	52

SP600 cable

PL no.	Length	Connectors	Connectors	Part number	Page
PL112	1.2 m (47.24 in)	26-pin high-density D-type socket	9-pin D-plug 9-pin D-socket	A-2172-0004	53

Ethernet cables

PL no.	Length	Connectors	Connectors	Part number	Page
	1 m (39.37 in)	RJ45 type plug	RJ45 type plug	P-CA78-0017	68
	360 mm (14.17 in)	RJ45 type plug	RJ45 type plug	P-CA82-0013	69
	5 m (196.85 in)	RJ45 type plug	RJ45 type plug	P-CA81-0002	70

CMM cable guide

www.renishaw.com

Manual probe head cable

Part number	Length
A-1016-6440	160 mm (6.3 in)

This straight cable has a 90° moulded plastic 5-pin DIN plug at each end and electrically connects Renishaw manual probe heads to the CMM quill.

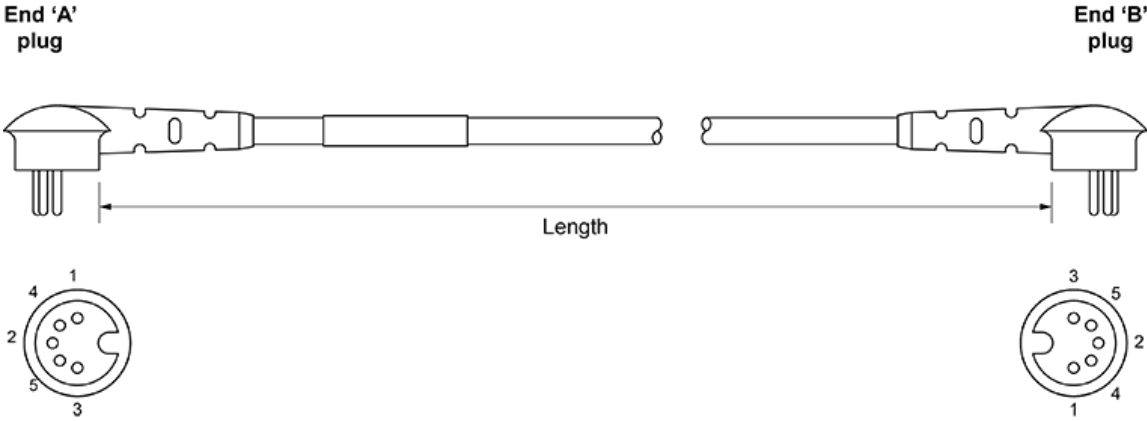

End 'A' and 'B'	Wire	Signal
1	Red	Head LED cathode
2	Screen	Screen
3	Yellow	Head LED anode
4	Blue	Probe circuit
5	Green	Probe circuit

CMM cable guide

www.renishaw.com

PL1, PL2 and PL3 manual probe head cables

Cable name	Part number	Length
PL1	A-1016-0004	260 mm to 710 mm (10.24 in to 27.95 in)
PL2	A-1016-0006	410 mm to 1.27 m (16.14 in to 50 in)
PL3	A-1016-0012	680 mm to 2.32 m (26.77 in to 91.34 in)

These coiled cables have an in-line 5-pin DIN plug at end 'A' and a 90° moulded plastic 5-pin DIN plug at end 'B'. They electrically connect Renishaw manual probe heads to the CMM quill.

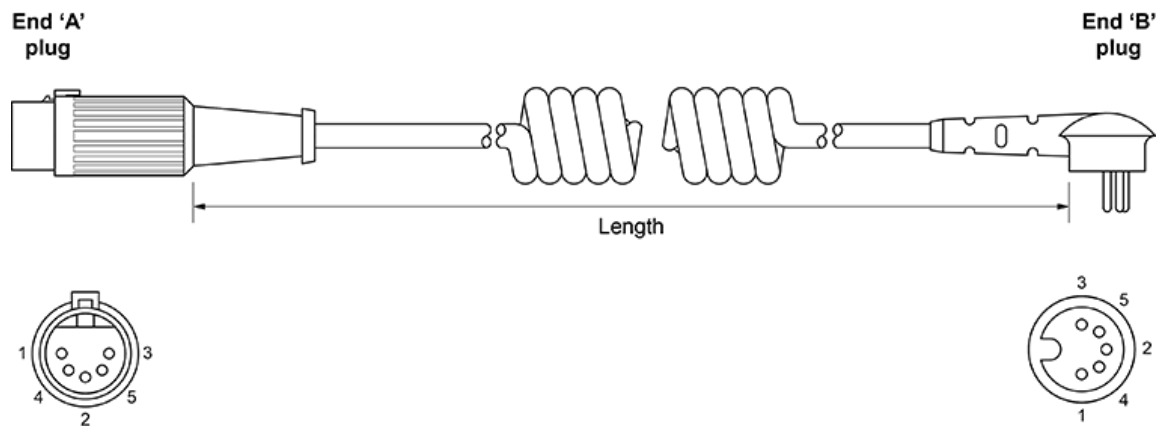

End 'A'	Wire	End 'B'	Signal
1	Red	1	Head LED cathode
2 and shell	Screen	2	Screen
3	Yellow	3	Head LED anode
4	Blue	4	Probe circuit
5	Green	5	Probe circuit

CMM cable guide

www.renishaw.com

PL4 manual probe head cable

Cable name	Part number	Length
PL4	A-1016-0001	4.5 m (177.17 in)

This straight cable has an in-line 5-pin DIN plug at end 'A' and a 90° moulded plastic 5-pin DIN plug at end 'B'. It electrically connects Renishaw manual probe heads to the CMM quill.

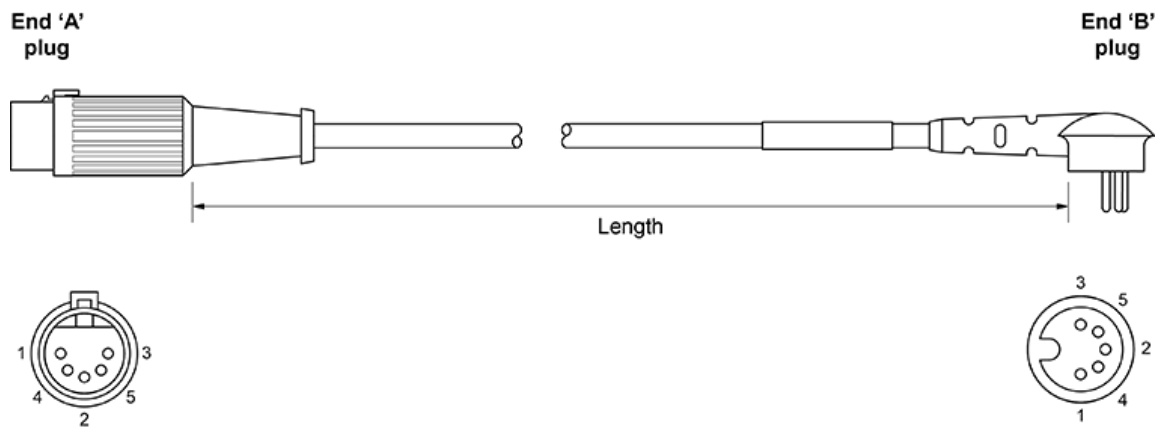

End 'A'	Wire	End 'B'	Signal
1	Red	1	Head LED cathode
2 and shell	Screen	2	Screen
3	Yellow	3	Head LED anode
4	Blue	4	Probe circuit
5	Green	5	Probe circuit

CMM cable guide

www.renishaw.com

PL5, PL6 and PL13 motorised probe head cables

Cable name	Part number	Length
PL5	A-1016-7672	400 mm to 800 mm (15.75 in to 31.5 in)
PL6	A-1016-7673	800 mm to 1.6 m (61.5 in to 62.99 in)
PL13	A-1016-7675	100 mm to 200 mm (3.94 in to 7.87 in)

These coiled cables have an in-line LEMO plug at end 'A' and a 90° Tuchel socket at end 'B'. They electrically connect Renishaw PH10T, PH10M or PH10MQ motorised probe heads to the CMM quill.

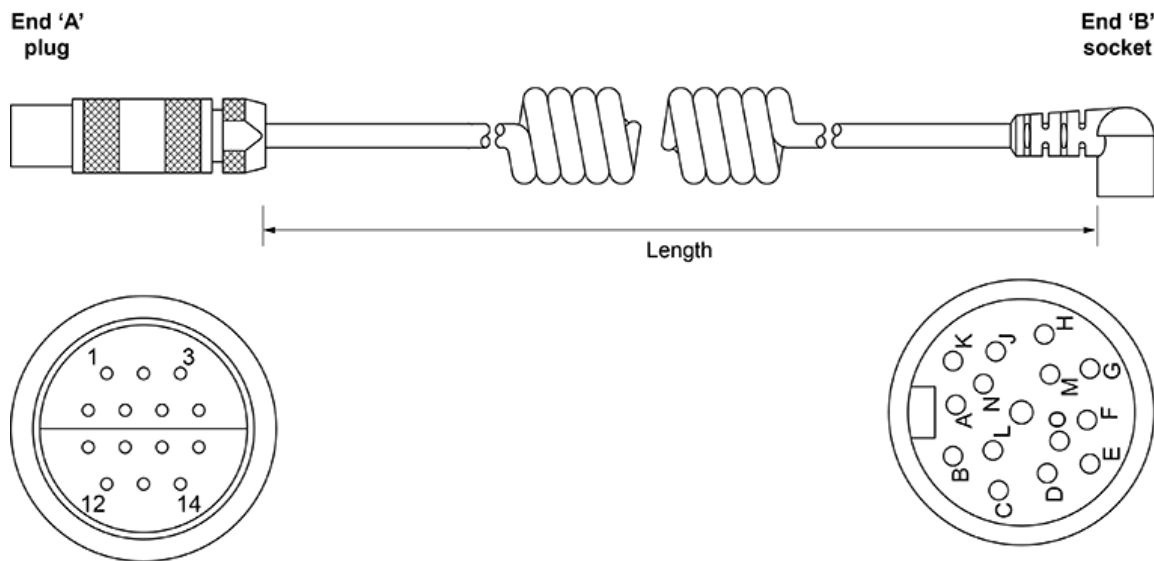

CMM cable guide

www.renishaw.com

End 'A'	End 'B'	Wire	Signal	Max. line current
1	E	Yellow	'B' axis feedback	n/a
2	D	Red	Ground sense	n/a
3	C	Brown	dc reference 12 V	n/a
4*	M	Grey	0 V	1000 mA
5	H	White	Locking motor 8 V dc nominal	350 mA
6	L	Green	'A' axis motor 12 V dc nominal	350 mA
7*	n/a	Not connected	Head present	n/a
8	F	Blue	'A' axis motor 12 V dc nominal	350 mA
9	A	Violet	'B' axis motor / probe contact	350 mA
10	B	Black	'B' axis motor / probe contact	350 mA
11	N and O	Screen	Screen	n/a
12	G	Orange	'A' axis feedback	n/a
13	J	Turquoise	LED and datum	15 mA
14	K	Pink	Motor probe switch	40 mA



* **NOTE:** The male pins 4 and 7 of the 14 way LEMO connector (end 'A') are linked together.

CMM cable guide

www.renishaw.com

PL7T probe interface cable

Cable name	Part number	Length
PL7T	A-1029-0166	3.1 m (122.1 in)

This straight cable has a 5-pin DIN plug at each end. It is a probe interface cable used to connect manual probe heads to the interface or OEM extension.

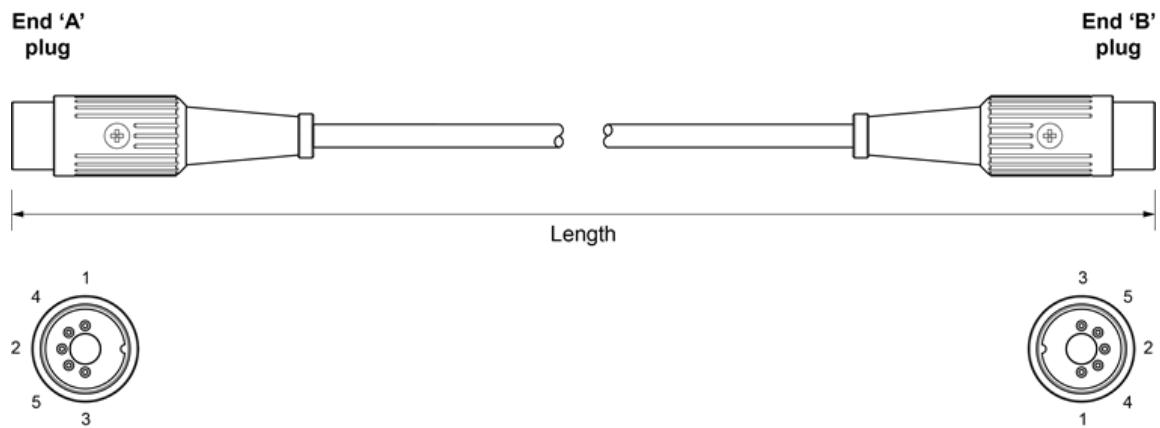

End 'A'	Wire	End 'B'	Signal
1	Red	1	Head LED cathode
2 and shell	Screen	2 and shell	Screen
3	Yellow	3	Head LED anode
4	Blue	4	Probe circuit
5	Green	5	Probe circuit

CMM cable guide

www.renishaw.com

PL10 manual probe head cable

Cable name	Part number	Length
PL10	A-1029-0111	100 mm (3.94 in)

This straight cable has an in-line LEMO plug at end 'A' and an in-line 5-pin DIN socket at end 'B' and. It electrically connects Renishaw manual probe heads to the CMM quill.

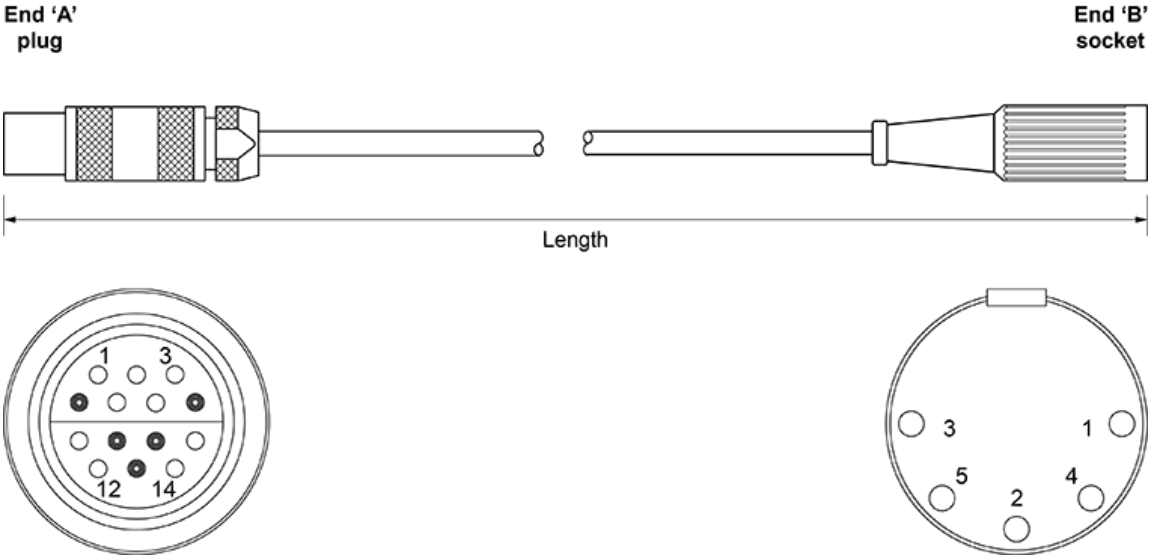

End 'A'	End 'B'	Wire	Signal
1	7	Red	Head LED cathode
2 and shell	11	Screen	Screen
3	13	Yellow	Head LED anode
4	10	Blue	Probe circuit
5	9	Green	Probe circuit

CMM cable guide

www.renishaw.com

PL12 motorised probe head cable

Cable name	Part number	Length
PL12	A-1016-7674	100 mm (3.94 in)

This straight cable has an in-line LEMO plug at end 'A' and a 90° Tuchel socket at end 'B'. It electrically connects Renishaw PH10T, PH10M or PH10MQ motorised probe heads to the CMM quill.

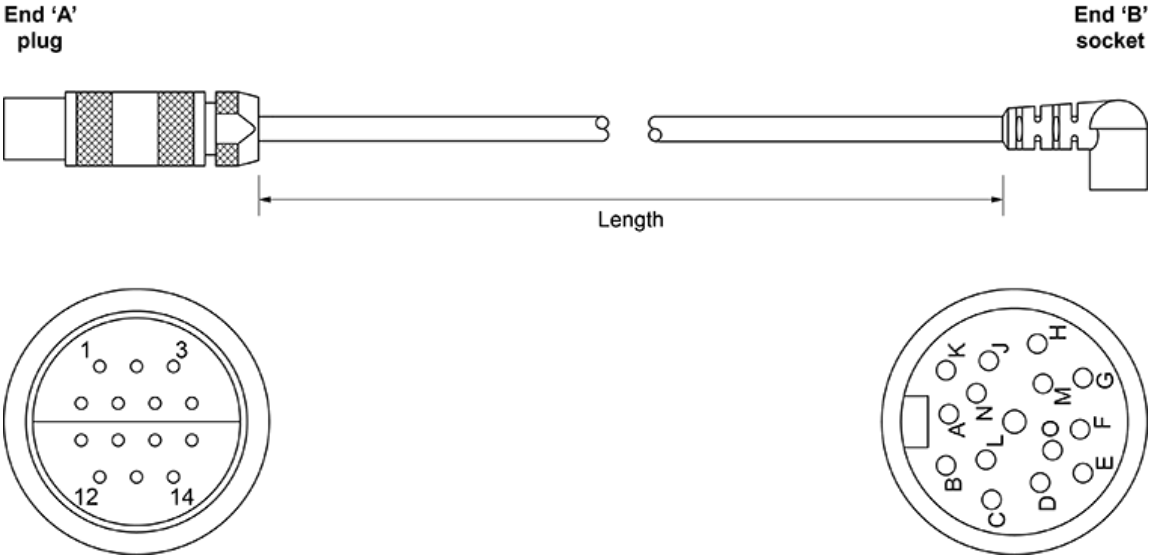

CMM cable guide

www.renishaw.com

End 'A'	End 'B'	Wire	Signal	Max. line current
1	E	Yellow	'B' axis feedback	n/a
2	D	Red	Ground sense	n/a
3	C	Brown	dc reference 12 V	n/a
4*	M	Grey	0 V	1000 mA
5	H	White	Locking motor 8 V dc nominal	350 mA
6	L	Green	'A' axis motor 12 V dc nominal	350 mA
7*	-	Not connected	Head present	n/a
8	F	Blue	'A' axis motor 12 V dc nominal	350 mA
9	A	Violet	'B' axis motor / probe contact	350 mA
10	B	Black	'B' axis motor / probe contact	350 mA
11	N and O	Screen	Screen	n/a
12	G	Orange	'A' axis feedback	n/a
13	J	Turquoise	LED and datum	15 mA
14	K	Pink	Motor probe switch	40 mA



* **NOTE:** The male pins 4 and 7 of the 14 way LEMO connector (end 'A') are linked together.

CMM cable guide

www.renishaw.com

PL14 manual probe head cable

Cable name	Part number	Length
PL14	A-1016-0003	590 mm to 1.83 m (23.23 in to 72.05 in)

This coiled cable has a 7-pin Amphenol plug at end 'A' and a 90° moulded plastic 5-pin DIN plug at end 'B'. It electrically connects Renishaw manual probe heads to the CMM quill.

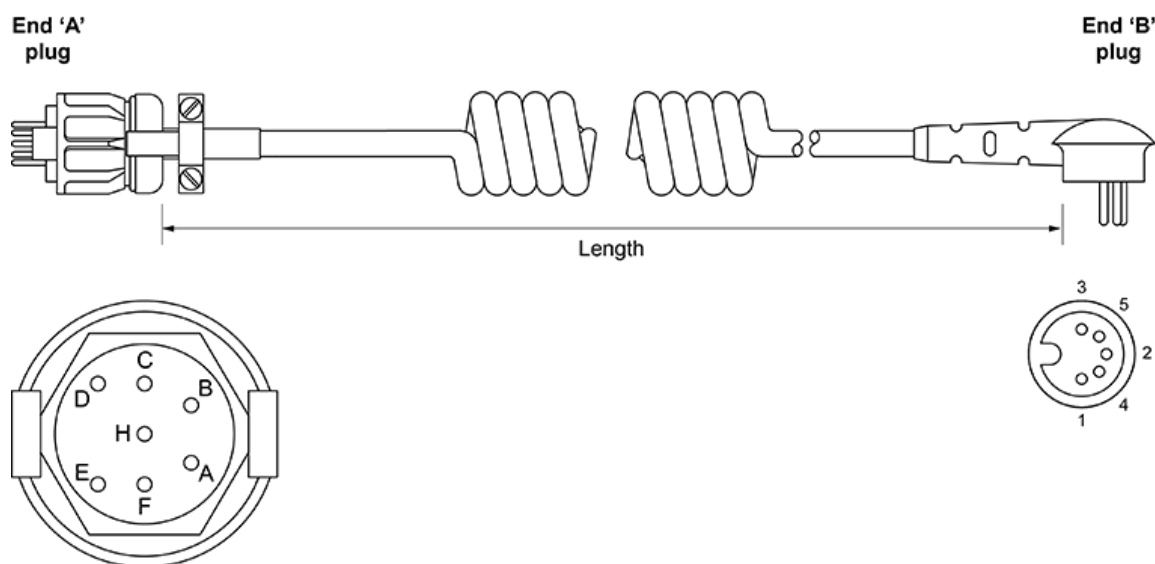

End 'A'	End 'B'	Wire	Signal
A	2	Screen	Screen
B	5	Green	Probe circuit
C	4	Blue	Probe circuit
D	3	Yellow	Head LED anode
E and F linked	1	Red	Head LED cathode
H	n/a	n/a	Not connected

CMM cable guide

www.renishaw.com

PL15 manual probe head cable

Cable name	Part number	Length
PL15	A-1004-0110	4.5 m (177.17 in)

This straight cable has an in-line 5-pin DIN plug at end 'A' and is unterminated at end 'B'. It electrically connects Renishaw manual probe heads to the CMM quill.

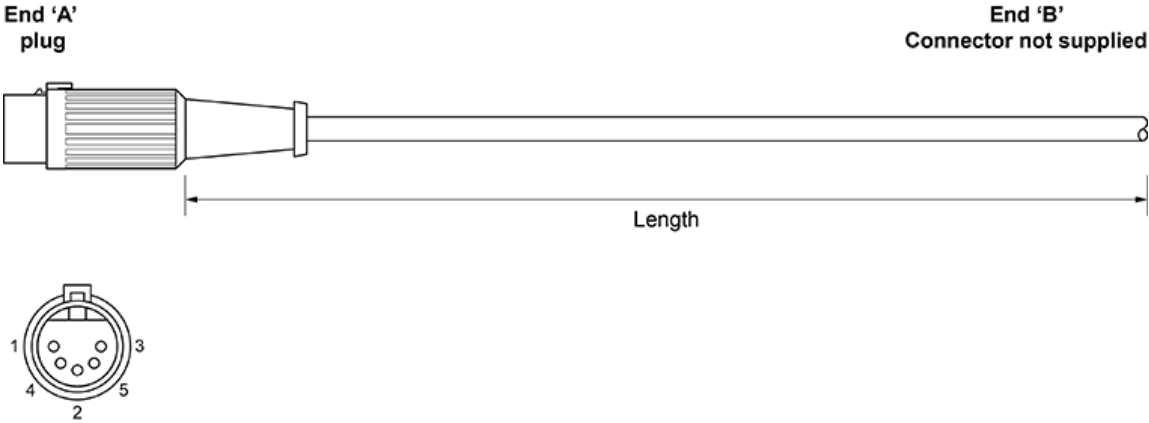

End 'A'	Wire	End 'B'	Signal
1	Red	1	Head LED cathode
2 and shell	Screen	2*	Screen
3	Yellow	3	Head LED anode
4	Blue	4	Probe circuit
5	Green	5	Probe circuit

i * NOTE: Link pin-2 of end 'B' to shell if fitting a connector with a metal cover.

CMM cable guide

www.renishaw.com

PL17 and PL18 manual probe head cables

Cable name	Part number	Length
PL17	A-1023-7024	160 mm to 260 mm (6.3 in to 10.24 in)
PL18	A-1023-7025	560 mm to 1.06 m (22.05 in to 41.73 in)

These coiled cables have a 90° moulded 5-pin DIN plug at end 'A' and an in-line LEMO plug at end 'B'. They electrically connect Renishaw manual probe heads to the CMM quill.

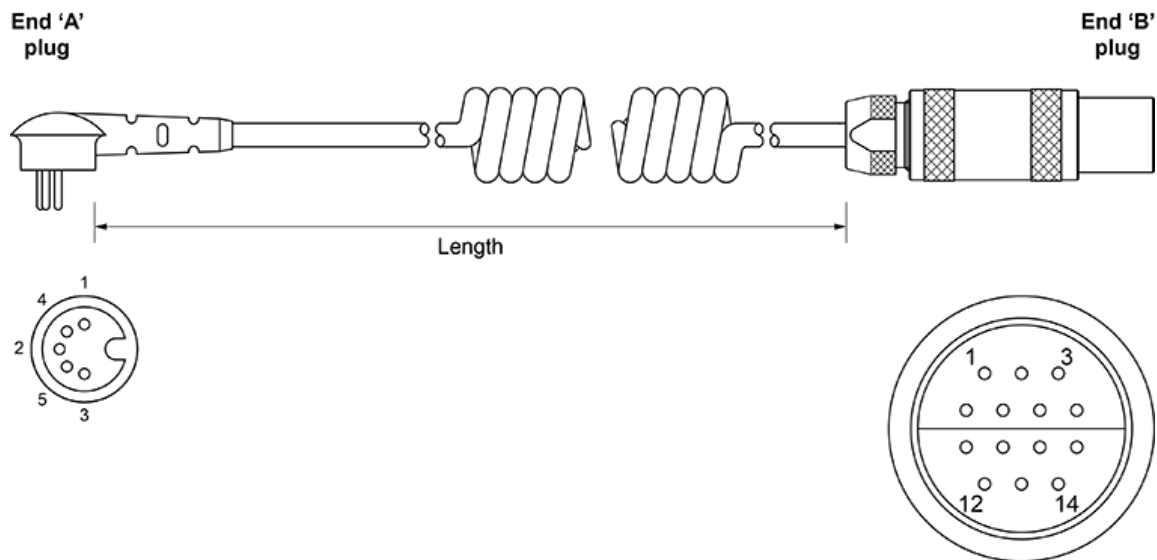

End 'A'	End 'B'	Wire	Signal
1	7	Red	Head LED cathode
2	11	Screen	Screen
3	13	Yellow	Head LED anode
4	9	Blue	Probe circuit
5	10	Green	Probe circuit



NOTE: A PL31 cable is available with inverted probe circuit pins if required.

CMM cable guide

www.renishaw.com

PL19, PL20, PL21 and PL40 autochange rack cables

Cable name	Part number	Length
PL19	A-1051-0199	5 m (196.85 in)
PL20	A-1051-0045	10 m (393.7 in)
PL21	A-1051-0102	15 m (590.55 in)
PL40	A-1054-0002	30 m (1181.1 in)

These straight ACR1 autochange rack cables have an in-line 25-pin D-type socket at end 'A' and a 25-pin D-type plug at end 'B'. They relay communications between the ACC2-2 controller and ACR1 rack. Connections are pin-to-pin, with the red / grey wire connected to pin 1 at each end.

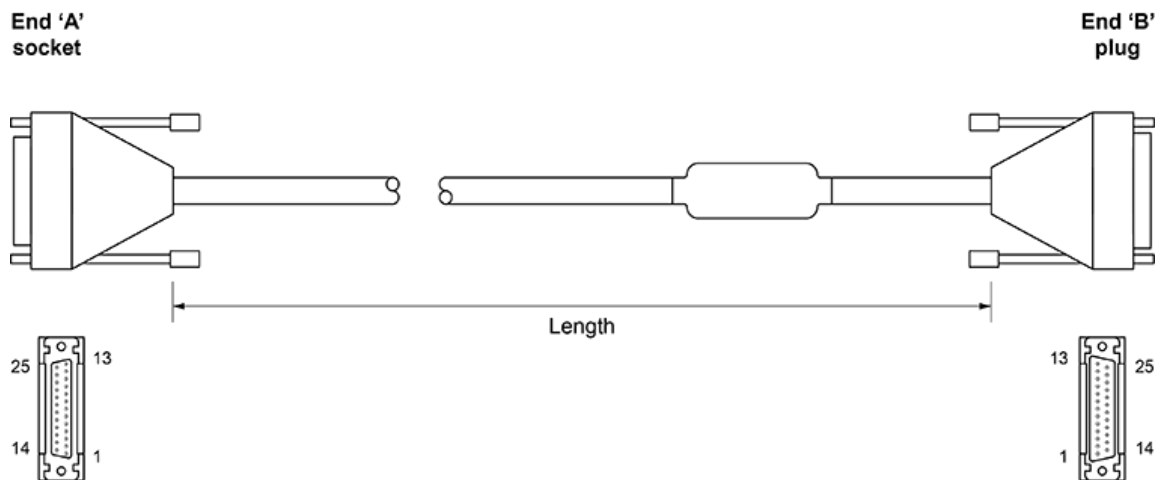

CMM cable guide

www.renishaw.com

Pin number	Signal	Pin number	Signal
1	Supply to ACR1 motor	14	Supply to ACR1 motor
2	0 V rack motor return	15	0 V motor return
3	Rack 0 V return for ACR1 motor	16	Rack 0 V
4	'Screwdriver' position feedback	17	Front IRED beam detector signal
5	Rear IRED beam detector signal	18	Rack probe contact no. 1
6	Rack probe contact no. 2	19	ACR1 overtravel signal no. 1
7	Rack precision reference voltage for the ACR1 position potentiometer	20	ACR1 'probe active' indicator no. 1
8	Rack lock error indicator no. 4	21	ACR1 'cycle error' indicator no. 3
9	ACR1 0 V	22	+ 15 V supply to ACR1 circuits
10	Rack 'change cycle' indicator no. 0	23	Ground sense
11	Rack 0 V, reserved for future use	24	Rack 0 V, reserved for future use
12	Rack 0 V, reserved for future use	25	Rack 0 V, reserved for future use
13	n/a		

CMM cable guide

www.renishaw.com

PL22 DIN to PICS adaptor cable

Cable name	Part number	Length
PL22	A-1057-0131	300 mm (11.81 in)

This straight cable has a 5-pin DIN socket at end 'A' and a 9-pin D-type plug at end 'B'. When linked to existing SSR (solid state relay) cables it allows input of the probe signal via Renishaw PICS (product interconnection system) of current interfaces such as PI 4-2 or PI 200.

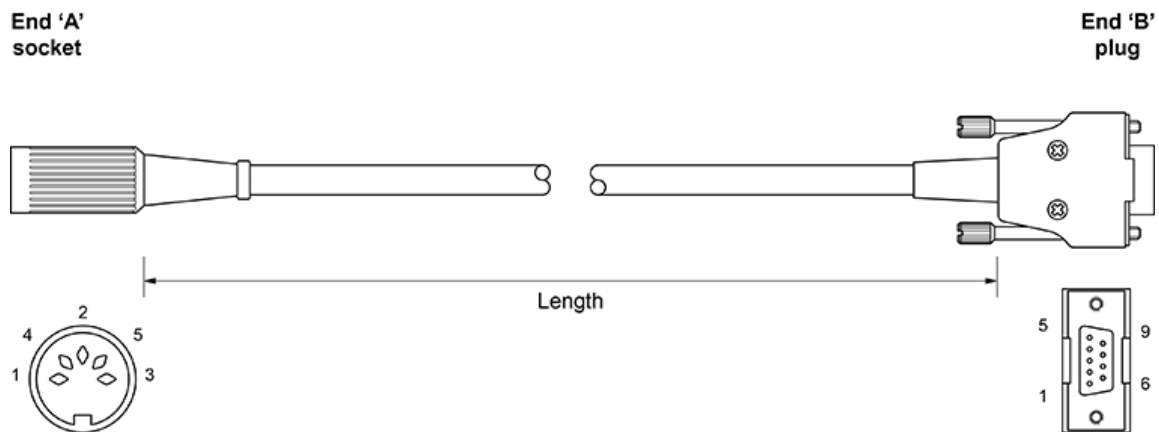

End 'A'	End 'B'	Wire	Signal*
1	3	Red	Head LED cathode
2 and shell	Shell	Screen	Screen
3	4 and 8	Yellow	Head LED anode
4	5	Blue	Probe circuit
5	9	Green	Probe circuit
n/a	1 and 6 linked	n/a	n/a

CMM cable guide

www.renishaw.com

PL24, PL25 and PL72T PICS cable

Cable name	Part number	Length
PL24	A-1016-0121	5 m (196.85 in)
PL25	A-1016-0120	300 mm (11.81 in)
PL72T	A-1016-7637	2 m (78.7 in)

These straight cables has a 9-pin D-type socket at end 'A' with a 9-pin D-type plug at end 'B'.

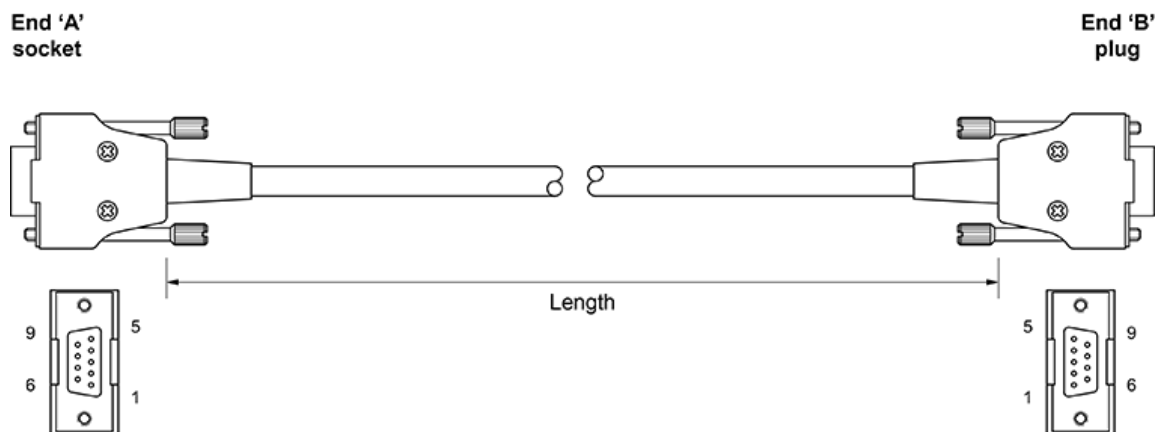

End 'A' and 'B'	Wire	PICS signal input	PICS signal output
1	Black	STOP	STOP
2	Brown	PPOFF (probe power off)	PPOFF
3	Violet	0 V	0 V
4	Orange	Reserved for Renishaw use	n/a
5	Red	Probe signal	SYNC output
6	Yellow	+ 5 V	HALT output
7	Blue	PDAMP (probe damping)	PDAMP
8	Green	LED OFF	LED OFF
9	White	Probe	n/a
Shell	Screen	Screen	Screen

i NOTE: Pink wire not used, cut back at both ends.

CMM cable guide

www.renishaw.com

PL26 PICS cable

Cable name	Part number	Length
PL26	A-1057-0132	600 mm (23.62 in)

This straight cable has a 9-pin D-type plug at end 'A' with a 7-pin DIN plug at end 'B'. These cables are used for adapting SSR output signals to Renishaw PICS (product interconnection system) inputs. This PICS input signal information is detailed below.

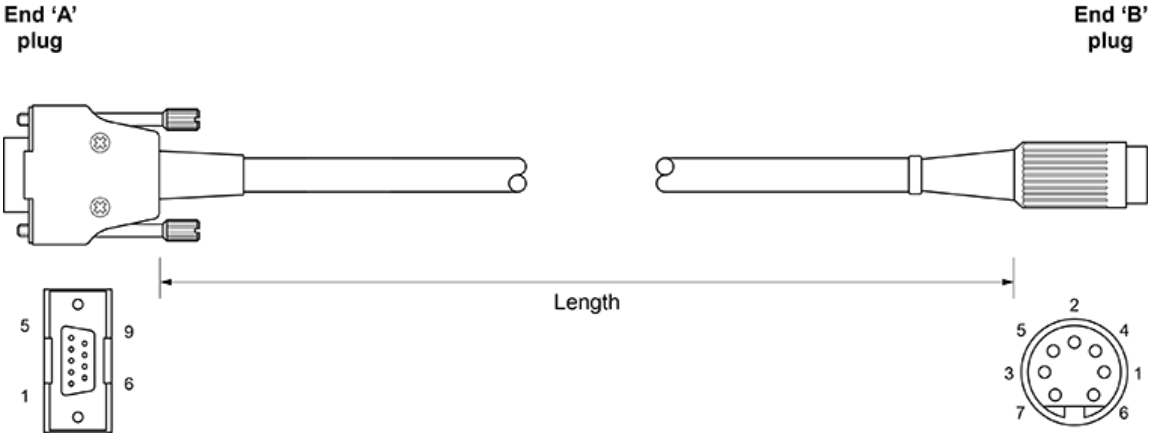

End 'A'	End 'B'	Wire	PICS signal input
1 and 6 linked	n/a	n/a	n/a
2	6	Red	PPOFF (probe power off)
3	1 and 7	Blue	0 V
4 and 8 linked	3	Yellow	LED OFF
5	5	White	Probe signal
9	4	Green	Probe return
Shell	Shell	Screen	Screen

CMM cable guide

www.renishaw.com

PL27 and PL29 manual probe head cables

Cable name	Part number	Length
PL27	A-1016-6370	225 mm to 450 mm (8.86 in to 17.72 in)
PL29	A-1016-6420	740 mm to 1.48 m (29.13 in to 58.27 in)

These coiled cables have 90° moulded 5-pin DIN plugs at each end and electrically connect Renishaw manual probe heads to the CMM quill.

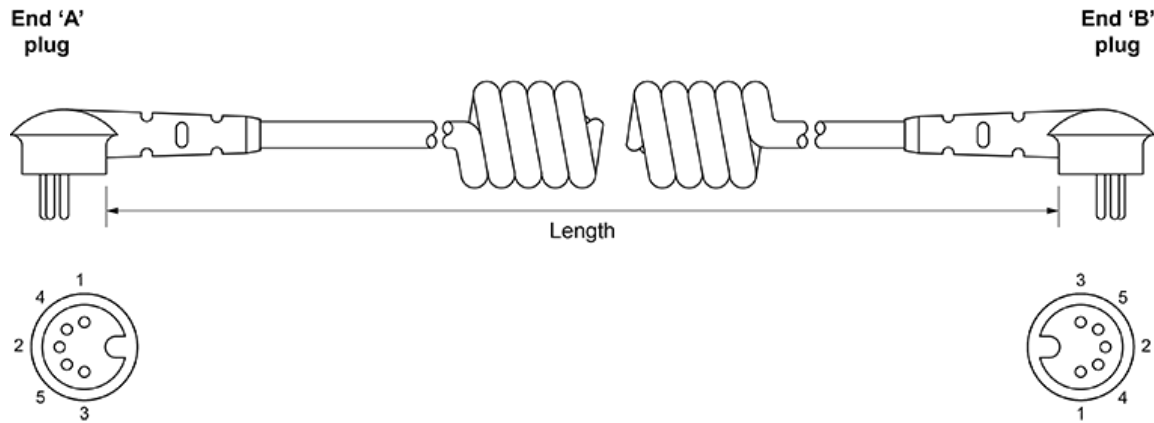

End 'A' and 'B'	Wire	Signal
1	Red	Head LED cathode
2	Screen	Screen
3	Yellow	Head LED anode
4	Blue	Probe circuit
5	Green	Probe circuit

CMM cable guide

www.renishaw.com

PL28 manual probe head cable

Cable name	Part number	Length
PL28	A-1016-6386	275mm to 550 mm (10.83 in to 21.65 in)

This is a coiled cable with a round 5-pin Franz Binder plug at end 'A' and a moulded 90° 5-pin DIN plug at end 'B'. The cable is used on Stiefelmayer CMM's to electrically connect Renishaw manual probe heads to the quill where a non-Stiefelmayer interface is being used. For applications using Stiefelmayer interfaces see details of the PL52 cable.

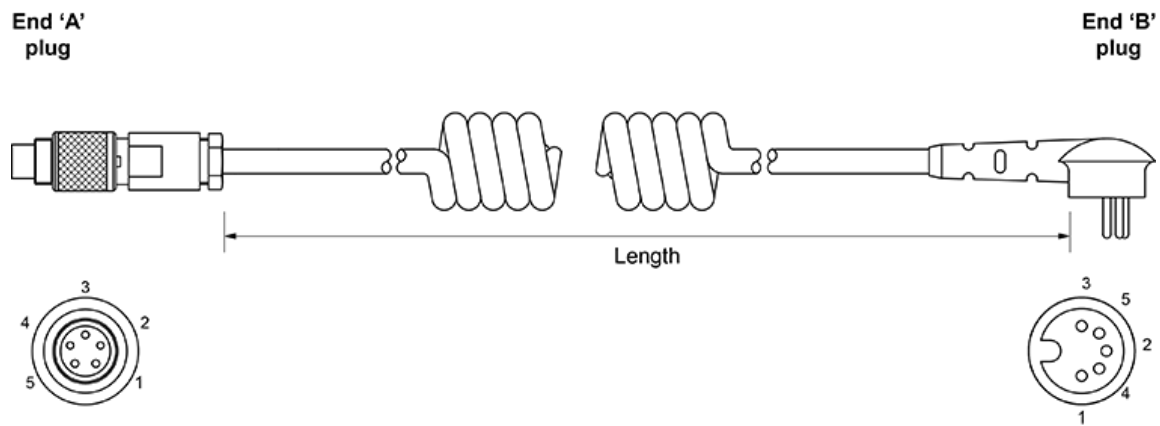

End 'A' and 'B'	Wire	Signal
1	Red	Head LED cathode
2	Screen	Screen
3	Yellow	Head LED anode
4	Blue	Probe circuit
5	Green	Probe circuit

CMM cable guide

www.renishaw.com

PL31 manual probe head cable

Cable name	Part number	Length
PL31	A-1049-8025	300 mm to 600 mm (11.81 in to 23.62 in)

These coiled cables have a 90° moulded 5-pin DIN plug at end 'A' and an in-line LEMO plug at end 'B'. They electrically connect Renishaw manual probe heads to the CMM quill.

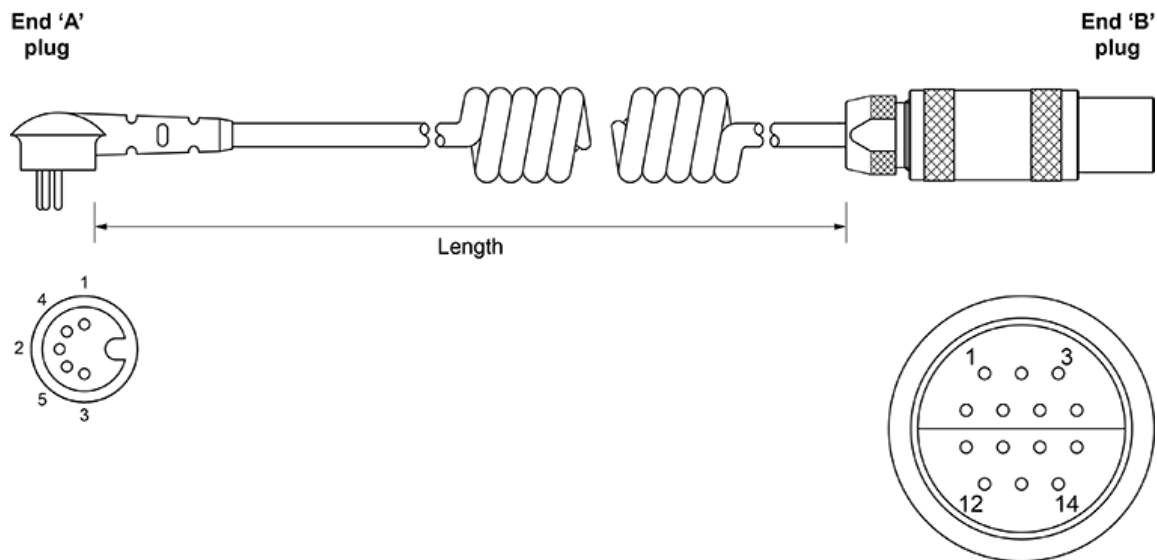

End 'A'	End 'B'	Wire	Signal
1	7	Red	Head LED cathode
2	11	Screen	Screen
3	13	Yellow	Head LED anode
4	10	Blue	Probe circuit
5	9	Green	Probe circuit



CAUTION: The probe circuit pins of the PL31 are inverted, check polarity requirements before use. If normal polarity is required, use the PL17 or PL18 cables.

CMM cable guide

www.renishaw.com

PL33 motorised probe head cable

Cable name	Part number	Length
PL33	A-1023-7056	3 m (118.11 in)

This straight cable has in-line LEMO socket or plug alternatives supplied loose for fitment on end 'A'. A 90° Tuchel socket is already fitted to end 'B'. This cable electrically connects Renishaw PH10T, PH10M or PH10MQ motorised probe heads to the CMM quill.

NOTE: A-1023-7055 is just the cable with Tuchel socket (without LEMO connectors).

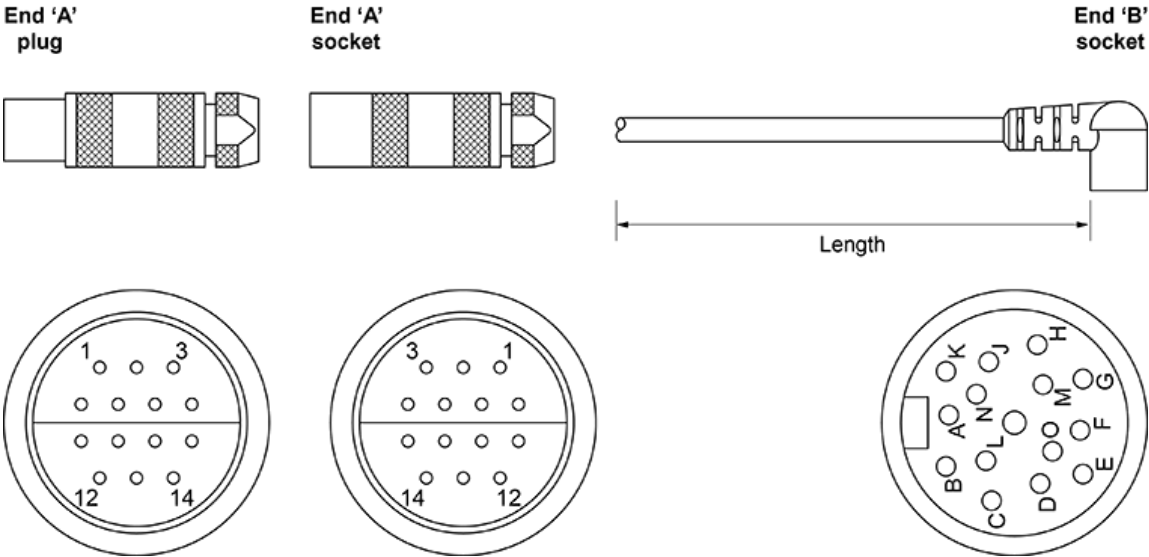

CMM cable guide

www.renishaw.com

End 'A' plug	End 'A' socket	End 'B'	Wire	Signal	Max. line current
1	3	E	Yellow	'B' axis feedback	n/a
2	2	D	Red	Ground sense	n/a
3	1	C	Brown	dc reference 12 V	n/a
4*	7 ^F	M	Grey	0 V	1000 mA
5	6	H	White	Locking motor 8 V dc nominal	350 mA
6	5	L	White / black	'A' axis motor 12 V dc nominal	350 mA
7*	4 ^F	n/a	Not connected	Head present	n/a
8	11	F	Blue	'A' axis motor 12 V dc nominal	350 mA
9	10	A	Violet	'B' axis motor / probe contact	350 mA
10	9	B	Black	'B' axis motor / probe contact	350 mA
11	8	N and O	Screen	Screen	n/a
12	14	G	Orange	'A' axis feedback	n/a
13	13	J	White / brown	LED and datum	15 mA
14	12	K	Green	Motor probe switch	40 mA



* **NOTE:** The male pins 4 and 7 of the 14 way LEMO plug (end 'A') are linked together.



F NOTE: The female pins 4 and 7 of the 14 way LEMO socket (end 'A') are linked together if this alternative connector type is required.

CMM cable guide

www.renishaw.com

PL37 probe signal cable

Cable name	Part number	Length
PL37	A-1054-0003	500 mm (19.69 in)

This straight cable has in-line 7-pin DIN plugs at each end. It electrically connects Renishaw probe interfaces and probe head controllers and passes SSR (solid state relay) signals between them.

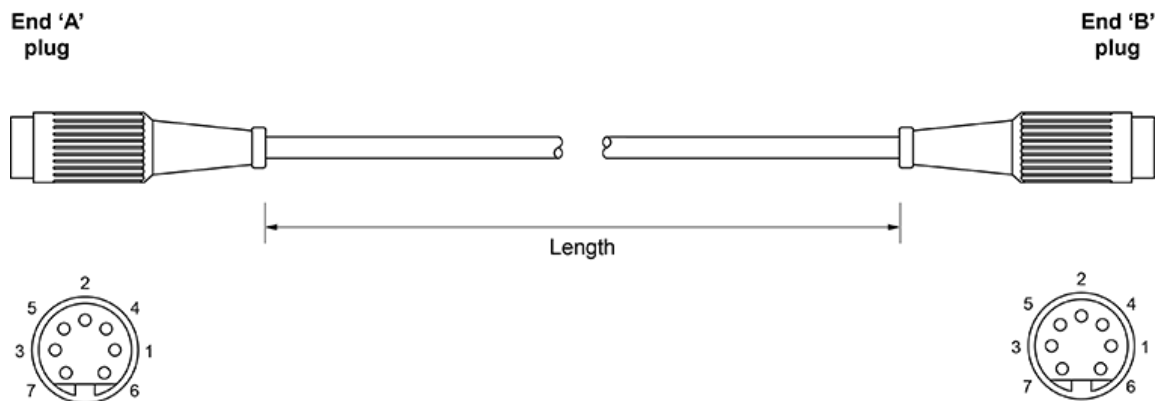

End 'A' and 'B'	Wire	Signal
1	Yellow	LED cathode
2 and shell	Screen	Screen
3	Green	LED anode
4	Red	Probe return
5	Blue	Probe signal
6	Black	Inhibit return
7	White	Inhibit signal

CMM cable guide

www.renishaw.com

PL38V, PL42V, PL44V, PL45V, PL46V and PL56V multiwire cables

Cable name	Part number	Length
PL38V	A-1016-7625	25 m (984.25 in)
PL42V	A-1016-7624	15 m (590.55 in)
PL44V	A-1016-7627	8 m (314.96 in)
PL45V	A-1016-7629	1.9 m (74.8 in)
PL46V	A-1016-7628	3.7 m (145.67 in)
PL56V	A-1016-7626	12 m (472.44 in)

These straight cables have a 90° micro-D plug fitted at one end with a 15-pin high-density D-type plug supplied loose for fitment to the other end. They are used to electrically connect Renishaw PH6M, PH10M and PH10MQ probe heads to multiwire probe system interfaces or controllers.

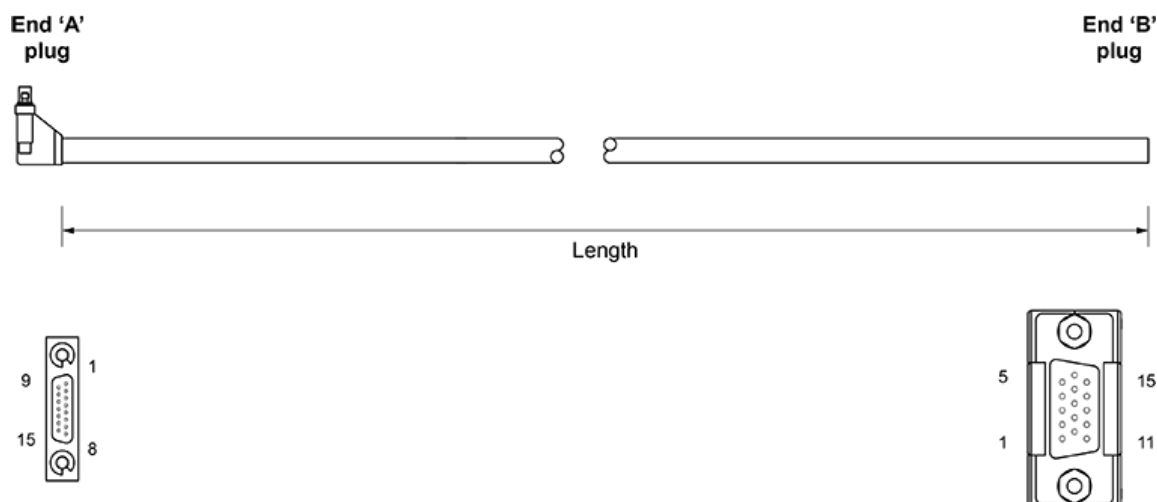

End 'A' and 'B'	Wire	End 'A' and 'B'	Wire
1	Brown	9	Coaxial screen
2 and screen	Screen	10	Coaxial inner
3	Green	11	Orange
4	Violet	12	Blue / white
5	Yellow	13	Grey
6	Red	14	Black / white
7	Blue	15	Brown / white
8	White		

CMM cable guide

www.renishaw.com

PL52 manual probe head cable

Cable name	Part number	Length
PL52	A-1016-6500	275 mm to 550 mm (10.83 in to 21.65 in)

This is a coiled cable with a round 5-pin Franz Binder plug at end 'A' and a moulded 90° 5-pin DIN plug at end 'B'. It is used on Stiefelmayer CMMs but differs significantly from the standard PL28 cable design.

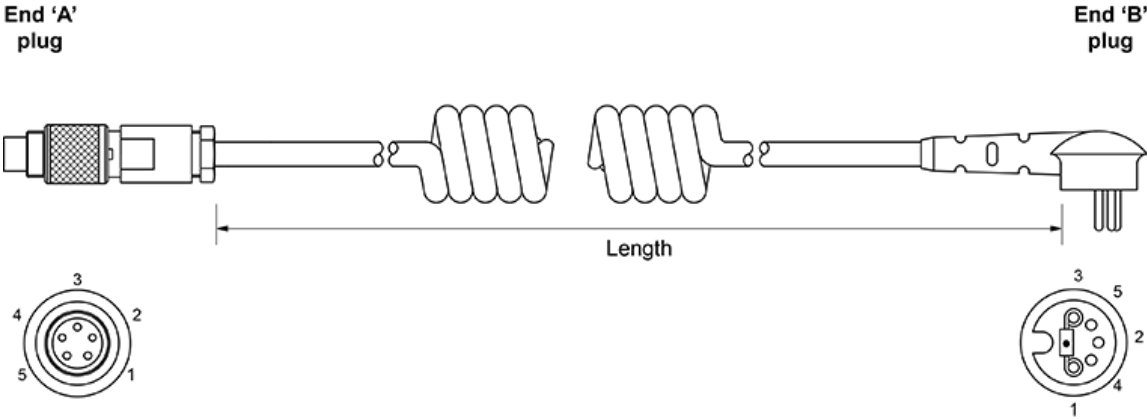

End 'A'	Wire	End 'B'	Signal
5	Red	1	Head LED cathode
n/a	Screen	2	Screen
4	Yellow	3	Head LED anode
1	Blue	4	Probe circuit
2	Green	5	Probe circuit

i NOTE: The in-line and linked resistor shown above are 1K2Ω with 1% tolerance. They protect Renishaw probe head LEDs from higher currents of non-Renishaw interfaces.

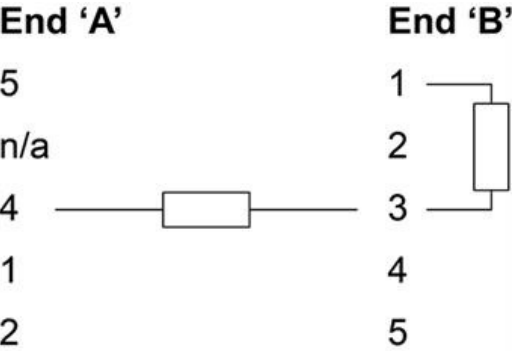

CMM cable guide

www.renishaw.com

PL63, PL64 and PL65 cables for the SCR200 rack

Cable name	Part number	Length
PL63	A-1016-7630	5 m (196.85 in)
PL64	A-1016-7631	10 m (393.7 in)
PL65	A-1016-7632	20 m (787.4 in)

These straight cables have in-line 6-pin mini DIN plugs at each end and are used to electrically connect SCR200 racks to PI 200 probe interfaces used with TP200 probes.

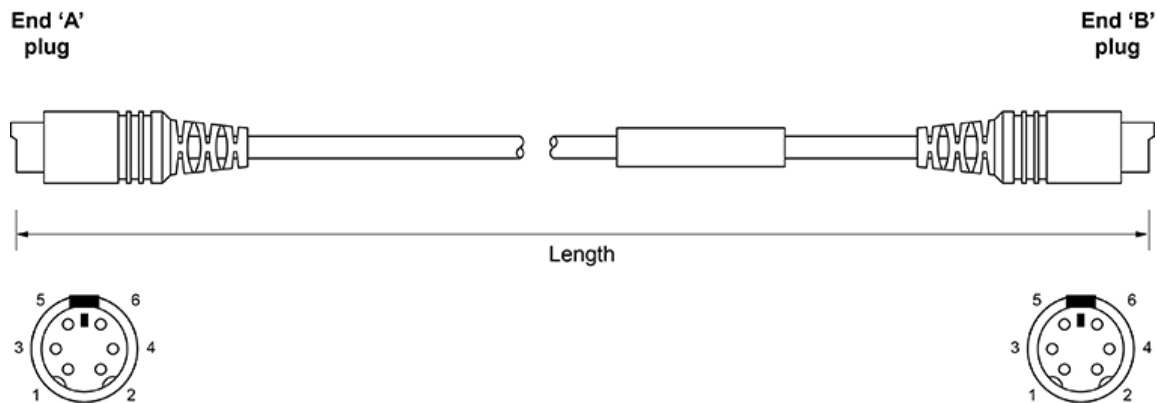

End 'A' and 'B'	Wire	Signal
1	Red	Remote set
2	Blue	Error
3	Green	Inhibit
4	Yellow	Power
5	White	0 V
6	Black	n/a
Shell	Shell	Screen

CMM cable guide

www.renishaw.com

PL69V and PL75V multiwire extension cables

Cable name	Part number	Length
PL69V	A-1016-7640	10.5 m (413.39 in)
PL75V	A-1016-7644	1 m (39.37 in)

These straight cables have a 15-pin high-density D-type socket at end 'A' and a 15-pin high-density D-type plug at end 'B'. They are used to extend the existing CMM multiwire probe system cables.

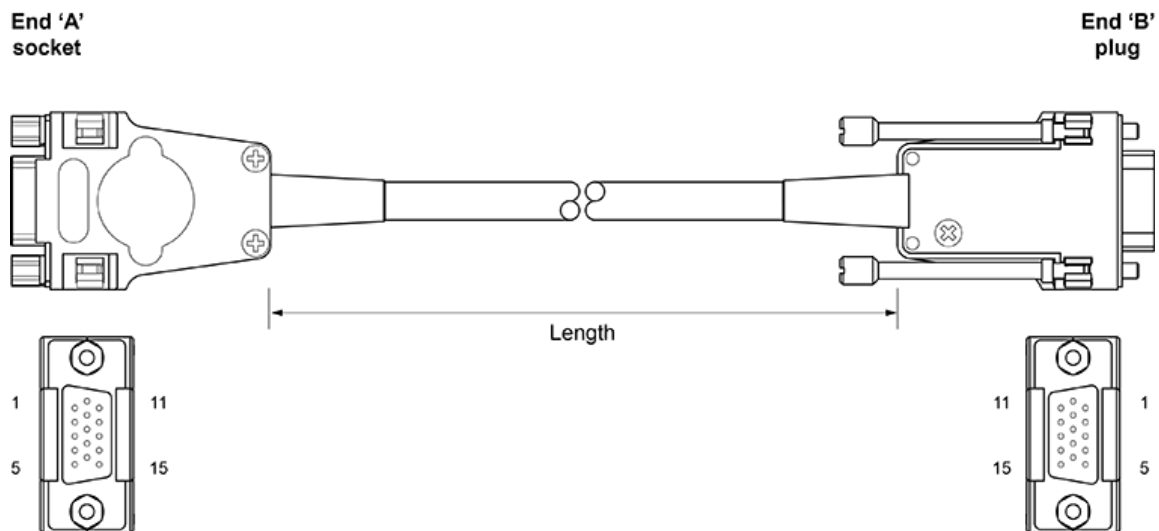

End 'A' and 'B'	Wire	End 'A' and 'B'	Wire
1	Brown	9	Coaxial screen
2	Grey	10	Coaxial inner
3	Green	11	Orange
4	Violet	12	White / blue
5	Yellow	13	Black
6	Red	14	White / brown
7	Blue	15	White / black
8	White	Shell	Screen

CMM cable guide

www.renishaw.com

PL70T four-way linking cable

Cable name	Part number	Length
PL70T	A-1016-7634	A - 400 mm (15.75 in) B - 500 mm (19.69 in) C - 2 m (78.74 in)

This four-way linking cable joins four connectors of differing types. End 'A' is a 9-pin D-type plug, end 'B' is a 9-pin D-type socket, end 'C' is a 15-pin high-density D-type socket and end 'D' is a 15-pin high-density D-type plug. It is used to combine a multiwire system with a standard probe system (using PICS) without the need for an IS 1-2 interface selector to route signals.

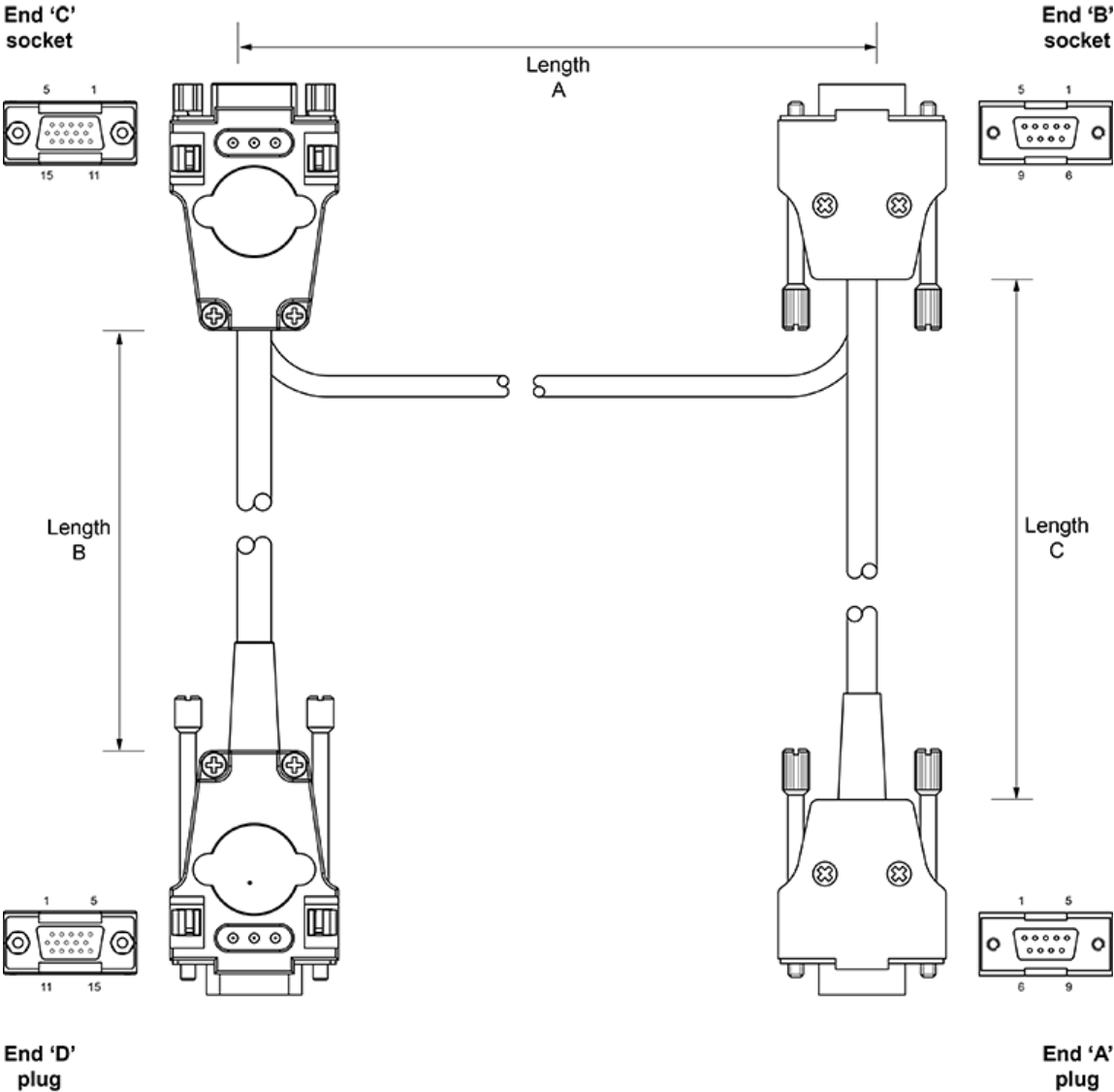

CMM cable guide

www.renishaw.com

End 'A'	Wire	End 'B'
A1	Black	B1
A2	Brown	B2
A3	Violet	B3
A4	Orange	B4
A5	Red	C13
A6	White	B6
A7	Yellow	B7
A8	Green	B8
A9	Blue	C3
End 'C'	Wire	End 'D'
C1	Grey	D1
C3	Blue (2 off)	A9 / D3
C4	Yellow	D4
C5	White	D5
C6	Orange	D6
C7	Green	D7
C8	Red	D8
C9	Coax outer	D9
C10	Coax core	D10
C11	Violet	D11
C12	White / blue	D12
C13	Red	A5
C14	Brown	D14
C15	Black	D15

CMM cable guide

www.renishaw.com

PL76T PICS three-way linking cable

Cable name	Part number	Length
PL76T	A-1016-7643	1 m (39.37 in)

This straight three-way linking cable joins connectors of differing types. End 'A' has a 9-pin D-type socket, end 'B' has a 9-pin D type socket and end 'C' has a 9-pin D-type plug. It is used to link a PICS compatible interface into an existing system and to output the signal to the CMM PC or controller.

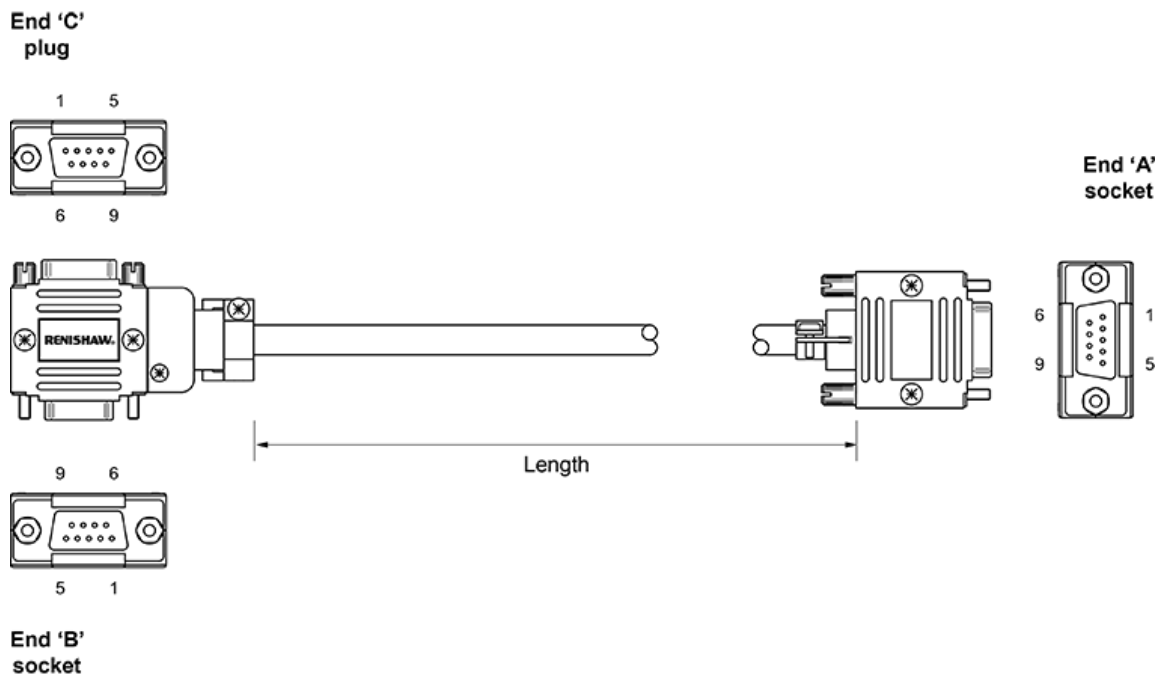

End 'A'	Wire	End 'B'	Wire	End 'C'
1	Black	1	White	1
2	Brown	2	White	2
3	Violet	3	White	3
4	n/a	4	n/a	4
5	Red	5	White	5
6	Yellow	6	White	6
7	Blue	7	White	7
8	Green	8	White	8
9	White	9	White	9



NOTE: The orange and pink wires are not used, cut back at both ends.

CMM cable guide

www.renishaw.com

PL82V video compatible probe cable

Cable name	Part number	Length
PL82V	A-1016-7648	5 m (196.85 in)

This straight cable has a 12-pin round Hirose-type plug at end 'A' and a 15-pin high-density D-type plug at end 'B'. It is used to link (the now obsolete) VP2 video cameras to the VPI 2 video probe interface or to link shank mounted SP600 version scanning probes to AC1 or AC2 cards. The 'V' suffix on cable markers indicate video system compatibility, signal details are shown below for both applications.

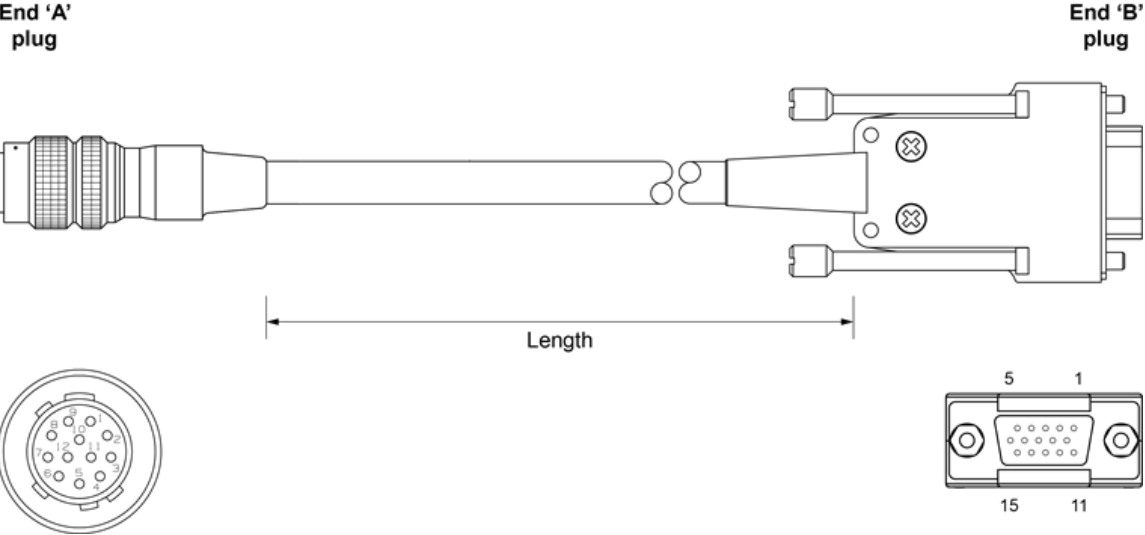

CMM cable guide

www.renishaw.com

End 'A'	Wire	End 'B'	MIH-SI signals	VP2 probe signals	SP600 probe signals
1	Brown	1	+ supply	Reference	Reference
2	Blue / white	12	LED anode	Probe sense return	0 V
3	Green	3	Head clock	Identification 0 V	+ 5 V
4	Violet	4	Head data	n/a	Y axis
5	Yellow	5	Head data	n/a	Z axis
6	Red	6	Ground	+ 12 V	+ 12 V
7	Blue	7	LED cathode	Illumination supply	- 12 V
8	White	8	n/a	Identification	Probe output
9	Orange	11	n/a	n/a	X axis
10	Grey	2	Head clock	n/a	n/a
11	Coaxial screen	9	Probe	Video 0 V	n/a
12	Coaxial inner	10	Ground	Video output	0 V power
-	-	13	n/a	n/a	n/a
-	-	14	n/a	n/a	n/a
-	-	15	n/a	n/a	n/a
Shell	Screen	Shell	Ground	Ground	Ground

CMM cable guide

www.renishaw.com

PL93 motorised probe head cable

Cable name	Part number	Length
PL93	A-1016-7676	100 mm (3.94 in)

This straight cable has an in-line LEMO plug at end 'A' and an in-line Tuchel socket at end 'B'. It electrically connects Renishaw PH10T, PH10M or PH10MQ motorised probe heads to the CMM quill.

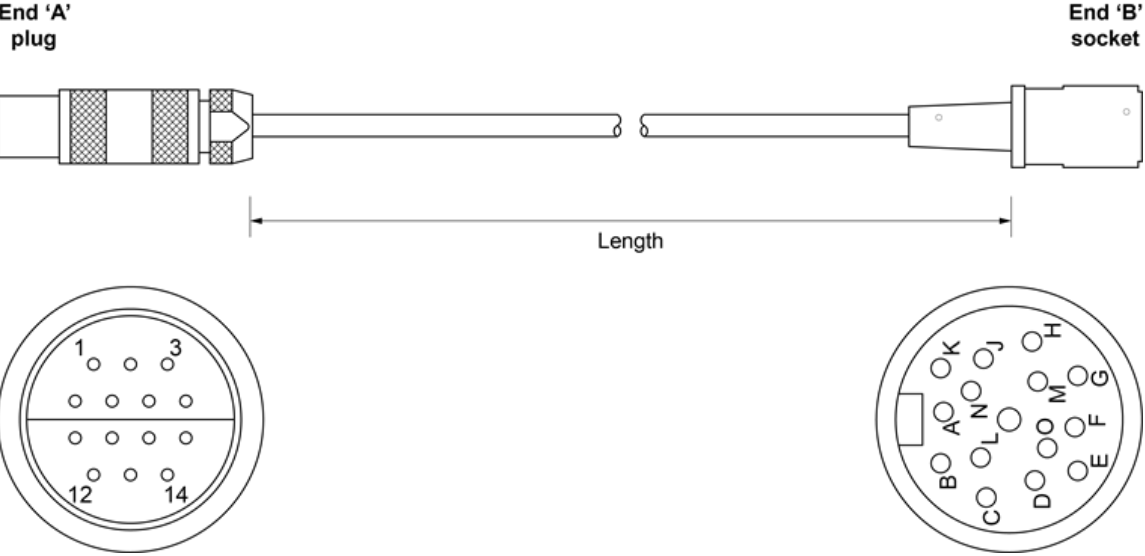

CMM cable guide

www.renishaw.com

End 'A'	End 'B'	Wire	Signal	Max. line current
1	E	Yellow	'B' axis feedback	n/a
2	D	Red	Ground sense	n/a
3	C	Brown	dc reference 12 V	n/a
4*	M	Grey	0 V	1000 mA
5	H	White	Locking motor 8 V dc nominal	350 mA
6	L	Green	'A' axis motor 12 V dc nominal	350 mA
7*	n/a	Not connected	Head present	n/a
8	F	Blue	'A' axis motor 12 V dc nominal	350 mA
9	A	Violet	'B' axis motor / probe contact	350 mA
10	B	Black	'B' axis motor / probe contact	350 mA
11	N and O	Screen	Screen	n/a
12	G	Orange	'A' axis feedback	n/a
13	J	Turquoise	LED and datum	15 mA
14	K	Pink	Motor probe switch	40 mA



* **NOTE:** The male pins 4 and 7 of the 14 way LEMO connector (end 'A') are linked together.

CMM cable guide

www.renishaw.com

PL97 twin SCR200 rack adaptor cable

Cable name	Part number	Length
PL97	A-1016-7660	260 mm (10.24 in)

This straight three-way adaptor cable has two in-line 6-pin mini DIN sockets at ends 'A' and 'B' with an in-line 6-pin mini DIN plug at end 'C'. It electrically connects two SCR200 racks to a single PI 200 probe interface for dual use.

End 'A' socket

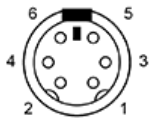

End 'C' plug

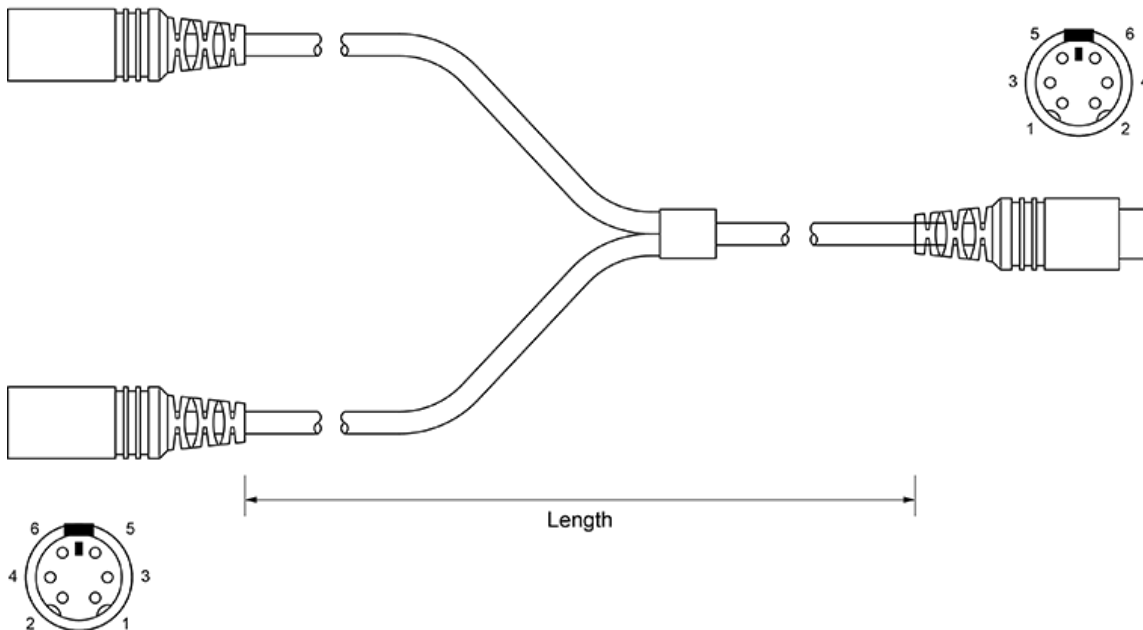
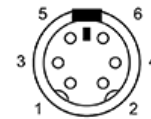

End 'B' socket



End 'A' and 'B'	End 'C'	Wire	Signal
1	1	Red	Remote reset
2	2	Blue	Error
3	3	Green	Inhibit
4	4	Yellow	Power
5	5	White	0 V
6	6	Black	n/a
Shell	Shell	Shell	Screen

CMM cable guide

www.renishaw.com

PL101 multiwire extension cable

Cable name	Part number	Length
PL101	A-1016-7662	500 mm (19.69 in)

This straight cable has a 15-pin high-density D-type socket at end 'A' and a 15-pin high-density D-type plug at end 'B'. It is used to extend the existing CMM multiwire probe system cables and to link probe interfaces.

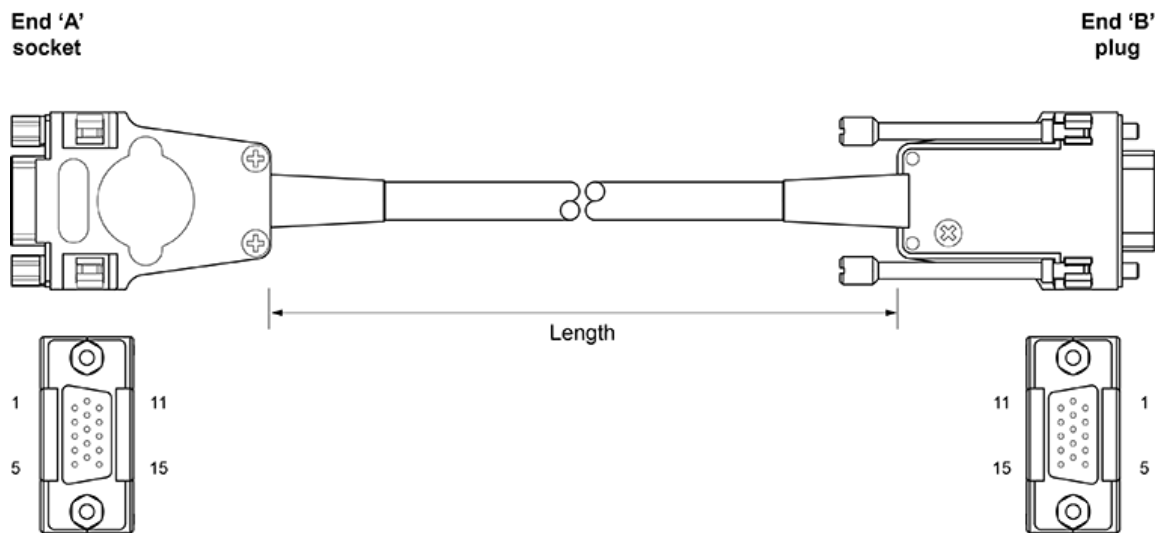

End 'A' and 'B'	Wire	End 'A' and 'B'	Wire
1	Brown	9	Coaxial screen
2	Grey	10	Coaxial inner
3	Green	11	Orange
4	Violet	12	White / blue
5	Yellow	13	Black
6	Red	14	White / brown
7	Blue	15	White / black
8	White	Shell	Screen

CMM cable guide

www.renishaw.com

PL104 PHS1 / PHS-2 power cable

Cable name	Part number	Length
PL104	A-2150-0481	30 m (1181.1 in)

This straight cable requires a 15-pin high-density D-type socket (NOT supplied) at end 'A' and a 15-pin high-density D-type plug (NOT supplied) at end 'B'.

It provides operating power to the PHS1 / PHS-2 servo-positioning head.

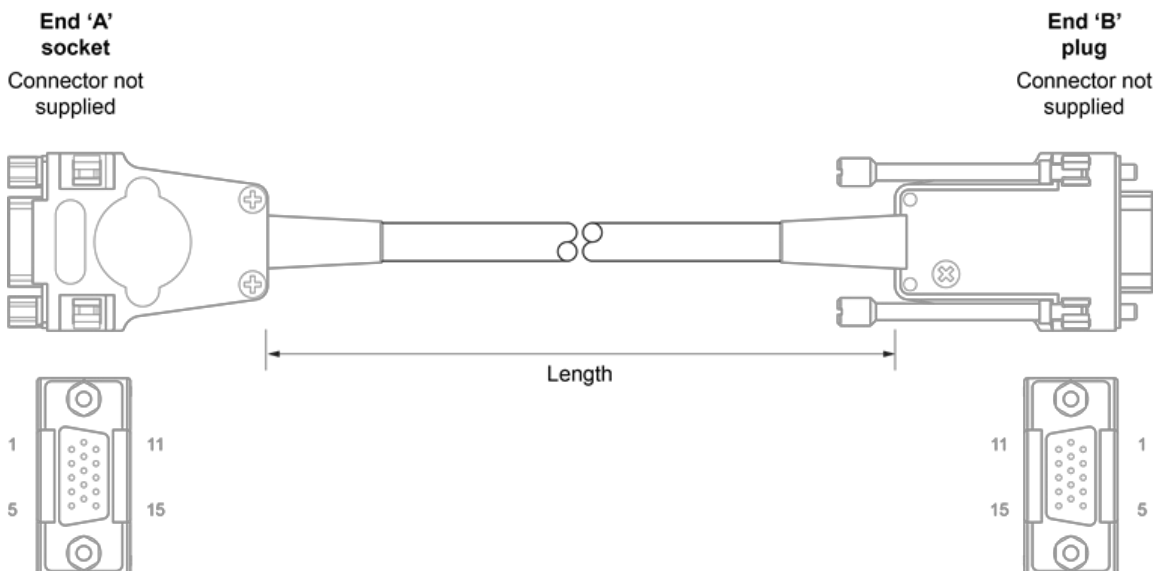

End 'A' and 'B'	Wire	Signal
6	Blue	+ 24 V
7	Yellow	0 V M
11	Grey	+ 24 V
12	Pink	0 V M
14	White	+ 12 V
15	Brown	Ground
Shell	Screen	Screen

i NOTE: Socket contact pin crimp.

CMM cable guide

www.renishaw.com

PL105 PHS1 / PHS-2 communications cable

Cable name	Part number	Length
PL105	A-2150-0482	30 m (1181.1 in)

This straight cable requires a 15-pin high-density D-type socket (NOT supplied) at end 'A' and a 15-pin high-density D-type plug (NOT supplied) at end 'B'.

It allows for communication to and from the PHS1 / PHS-2 servo-positioning head.

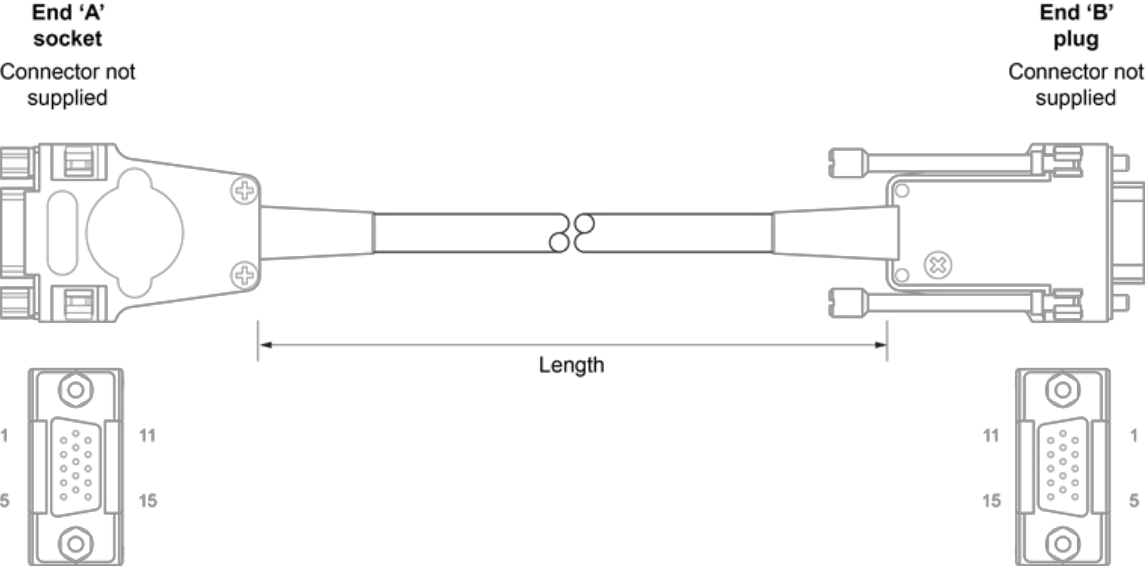

i NOTE: Socket contact pin crimp.

End 'A' and 'B'	Wire	Signal
3	Black	Twisted pair data
5	Red	FROM head
8	Black	Twisted pair data
10	White	TO head
Shell	Screen	Screen

CMM cable guide

www.renishaw.com

PL106 PHS1 / PHS-2 probe signal cable

Cable name	Part number	Length
PL106	A-2150-0483	30 m (1181.1 in)

This straight cable requires a 15-pin high-density D-type socket (NOT supplied) at end 'A' and a 15-pin high-density D-type plug (NOT supplied) at end 'B'.

It allows for probe signals to and from the PHS1 / PHS-2 servo-positioning head.

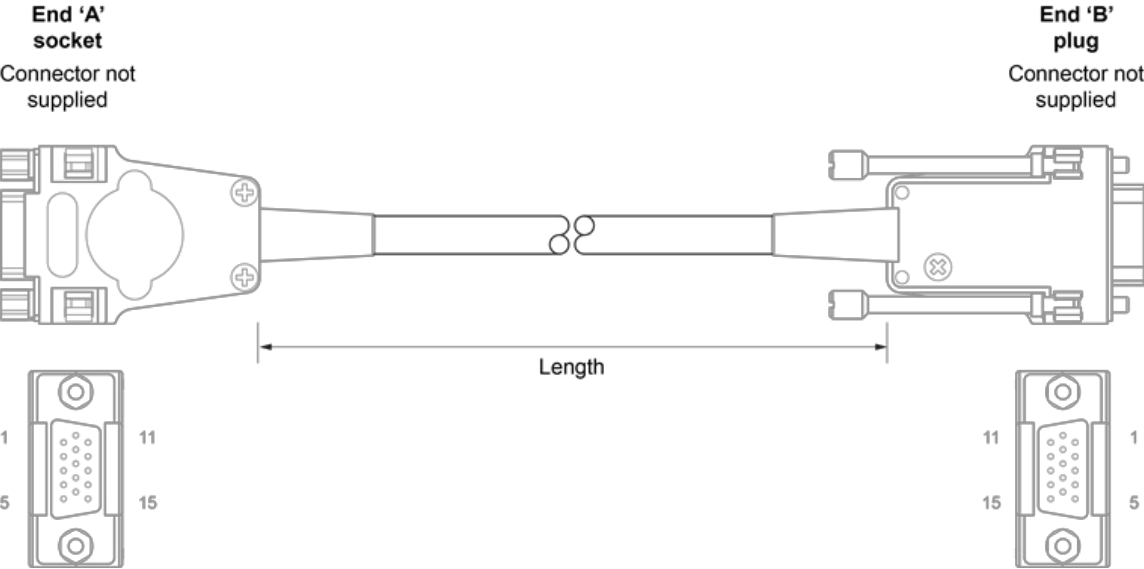

CMM cable guide

www.renishaw.com

End 'A'	Wire	End 'B'	Signal
1	Brown	1	Signal 5
2	Black / white	2	Screen
3	Green	3	0 V return
4	Violet	4	Signal 2
5	Yellow	5	Signal 3
6	Red	6	Power +
7	Blue	7	Power -
8	White	8	Probe identification
9	Coaxial outer	9	-
10	Coaxial inner	10	-
11	Orange	11	Signal 1
12	Blue / white	12	0 V reference
13	Grey	13	Probe signal
For OTM3M / OTP6M fit in parallel with pin 3 (cut back if not required)	Brown / white - -	For OTM3M / OTP6M fit in parallel with pin 3 (cut back if not required)	Non-contact probe - -
Shell	Screen	Shell	Screen

CMM cable guide

www.renishaw.com

PL107 PHS1 / PHS-2 overtravel cable

Cable name	Part number	Length
PL107	A-2150-0484	30 m (1181.1 in)

This straight cable requires a 15-pin high-density D-type socket (NOT supplied) at end 'A' and a 15-pin high-density D-type plug (NOT supplied) at end 'B'.

It is used for the overtravel signal between the PHS1 / PHS-2 servo-positioning head and the PHS PC card.

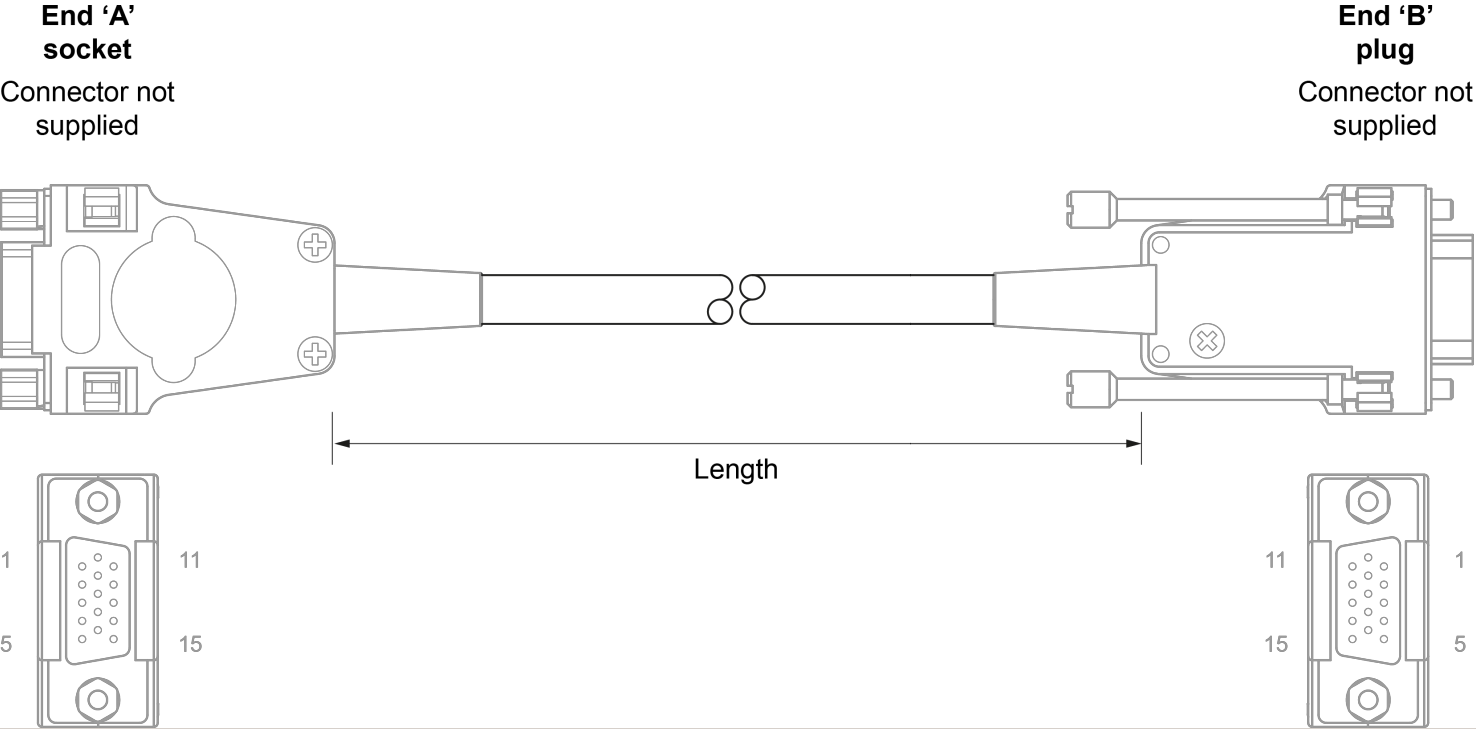

End 'A' and 'B'	Wire
Pins 1 to 13 not used	-
14	White
15	Brown
Shell	Screen

i NOTE: Plug contact pin crimp.

CMM cable guide

www.renishaw.com

PL112 PICS adaptor cable

Cable name	Part number	Length
PL112	A-2172-0004	1.2 m (47.24 in)

This straight three-way adaptor cable has a 26-pin high-density D-type socket at end 'A', then branches out to a 9-pin D-plug at end 'B' and a 9-pin D-socket at end 'C'. It electrically connects and adapts PICS signals for Renishaw or equivalent counter cards.

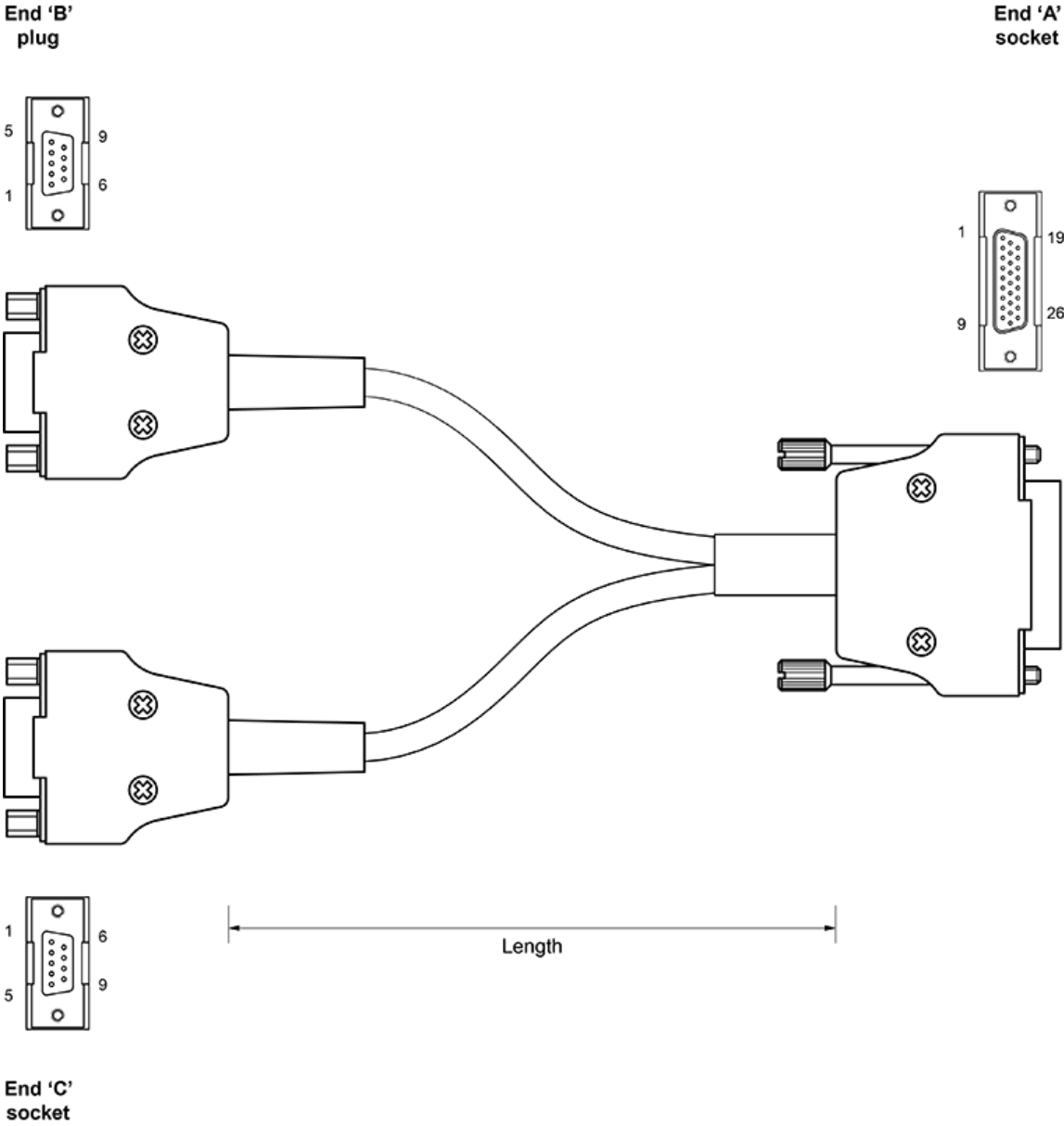

CMM cable guide

www.renishaw.com

End 'A'	End 'B'	End 'C'	Wire	Signal
1	1	-	Red	Stop (out)
2	2	-	Blue	PPOFF (out)
3	3	-	Green	0 V (out)
4	4	-	Yellow	+ 5 V (out)
5	5	-	White	SYNC (out)
6	6	-	Black	HALT (out)
7	7	-	Brown	PDAMP (out)
8	8	-	Violet	LEDOFF (out)
9	9	-	Orange	READ (out)
10	-	9	Orange	Probe return
17	-	-	-	Overtravel return
18	-	-	-	Overtravel
19	-	8	Violet	LEDOFF (in)
20	-	7	Brown	PDAMP (in)
21	-	6	Black	150 Ohm pull up resistor
22	-	5	White	Probe signal
23	-	4	Yellow	LED anode (in)
24	-	3	Green	0 V (in)
25	-	2	Blue	PPOFF (in)
26	-	1	Red	Stop (in)
Shell	Shell	Shell	Screen	Screen



NOTE: Pins 11 to 16 are not connected.

CMM cable guide

www.renishaw.com

PL156 interpolator cable for IU80

Cable name	Part number	Length
PL156	A-1016-7129	60 mm (23.62 in)

This straight cable has a 26-pin high-density D-type socket at end 'A' and is unterminated at end 'B' (the connector is not supplied). It is used to link the IU80 interpolator unit of the SP80 scanning probe system to the CC6 or equivalent counter card.

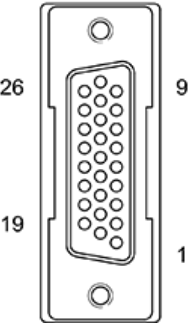
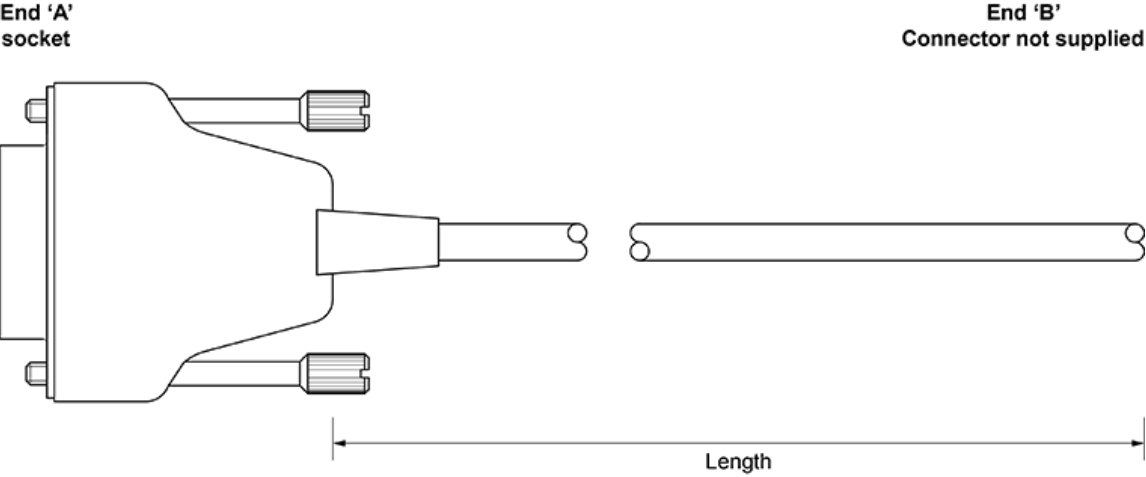

CMM cable guide

www.renishaw.com

End 'A'	Wire	Signal	End 'A'	Wire	Signal
1	Red	X axis log A	15	Pink	Y axis log A
2	Not connected	-	16	Turquoise	Y axis log B
3	White / blue	IU80 reset	17	Grey	Y axis log B
4	Blue	IU80 error	18	Not connected	-
5	Not connected	Not connected	19	Not connected	-
6	Green	Z axis log	20	Red / blue	Z axis log A
7	Not connected	-	21	Green / red	Z axis log A
8	Yellow / blue	Probe present	22	Yellow / red	Z axis log B
9	Yellow	Green LED off	23	White / red	+ 9 V to + 18 V
10	White	Red LED on	24	Black / red	+ 5 V
11	Black	X axis log A	25	Brown / red	0 V
12	Brown	X axis log B	26	Not connected	-
13	Violet	X axis log B	Shell	Screen	Screen
14	Orange	Y axis log A			

CMM cable guide

www.renishaw.com

PL157 machine cable adaptor for IU80

Cable name	Part number	Length
PL157	A-1016-7132	230 mm (9.06 in)

This straight cable has a 15-pin high-density D-type socket at end 'A' and an in-line 14-pin LEMO plug at end 'B'. It is used to electrically connect the SP80 scanning probe to the CMM quill.

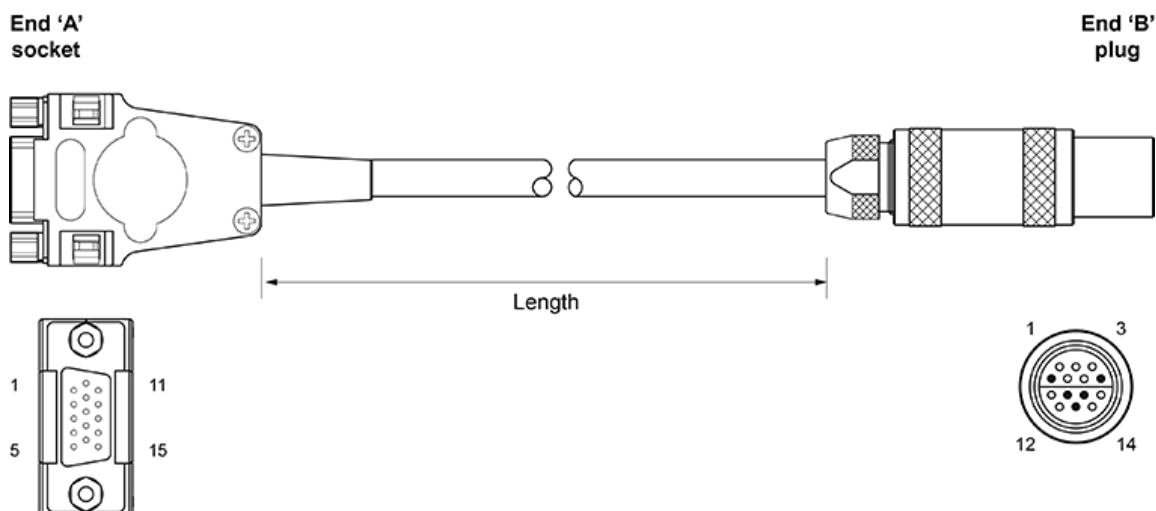

End 'A'	End 'B'	Wire	Signal
1	13	Orange	V reference
2	4	Thick white	0 V
3	-	-	Not connected
4	12	Grey	Cos Z
5	2	Red	Cos Y
6	8	Yellow	Cos X
7	10	Thick brown	+ 9 V to + 18 V
8	-	-	Not connected
9	14	Pink	Probe present
10	3	Black	Green LED on
11	5	Brown	Red LED on
12	9	Violet	Sin Z
13	1	Blue	Sin Y
14	6	Green	Sin X
15	-	-	Not connected
-	11	Inner screen	Inner screen
Shell	Shell	Shell	Screen

CMM cable guide

www.renishaw.com

PL158 interpolator cable for IU80

Cable name	Part number	Length
PL158	A-1016-7133	1 m (39.37 in)

This straight cable has a 26-pin high-density D-type socket at end 'A' and a 26-pin D-type plug at the other end. It is used to link the IU80 interpolator unit of the SP80 scanning probe system to the CC5, CC6 or equivalent counter card.

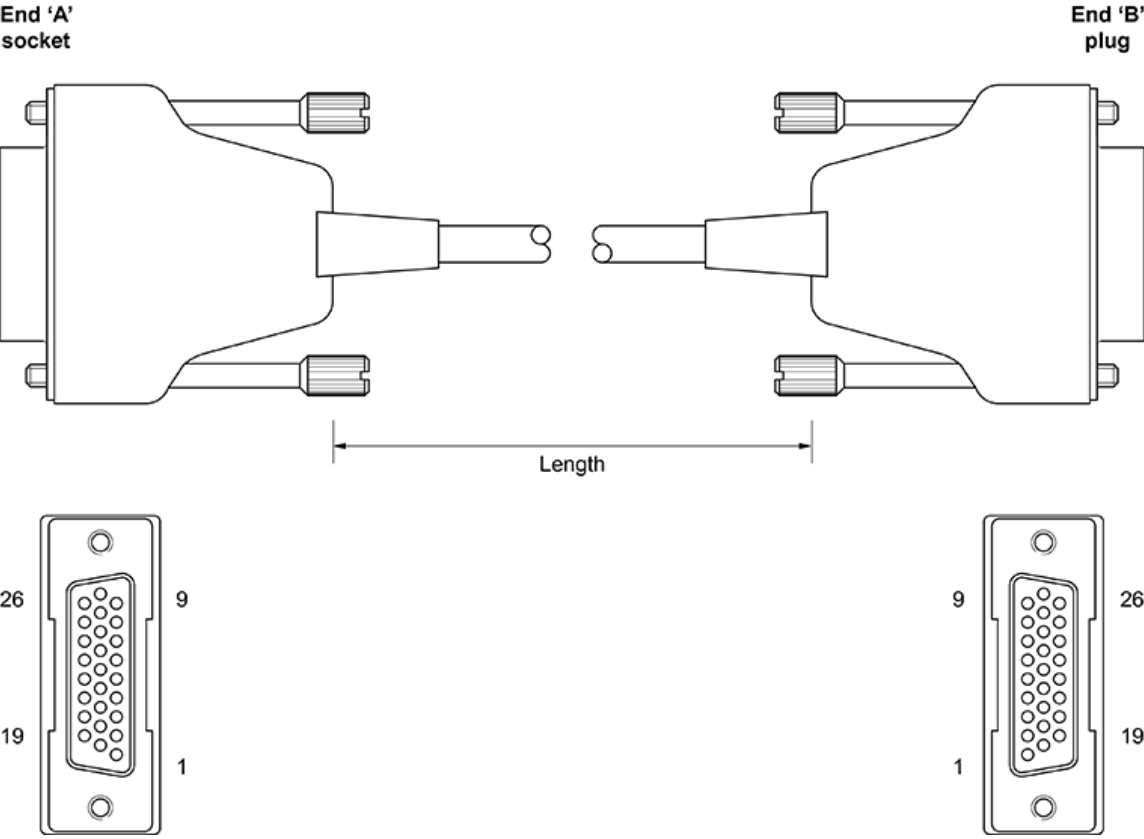

CMM cable guide

www.renishaw.com

End 'A'	Wire	End 'B'	End 'A'	Wire	End 'B'
1	Red	1	15	Yellow / red	15
2	Not connected	-	16	White / red	16
3	Green	9	17	Black / red	17
4	Yellow	4	18	Brown / red	25
5	White	5	19	Yellow / blue	19
6	Black	6	20	White / blue	20
7	Not connected	-	21	Black / blue	21
8	Violet	2	22	Orange / blue	22
9	Orange	7	23	Yellow / green	24
10	Pink	8	24	White / green	23
11	Turquoise	11	25	Not connected	-
12	Grey	12	26	Blue	26
13	Blue / red	13	Shell	Screen	Shell
14	Green / red	14			

CMM cable guide

www.renishaw.com

PL163, PL164 and PL171 dedicated MCU cables

Cable name	Part number	Length
PL163	A-1016-8098	5 m (196.85 in)
PL164	A-1016-8099	10 m (393.7 in)
PL171	A-1016-8100	20 m (787.4 in)

These straight cables have a 9-pin D-type socket at end 'A' with a 9-pin D-type plug at end 'B' and are connected pin-to-pin. They are used as dedicated cables for the Renishaw MCU joystick units, signal information is shown below.

WARNING: These cables are not suitable for Renishaw PICS cables as pin 5 is not connected.

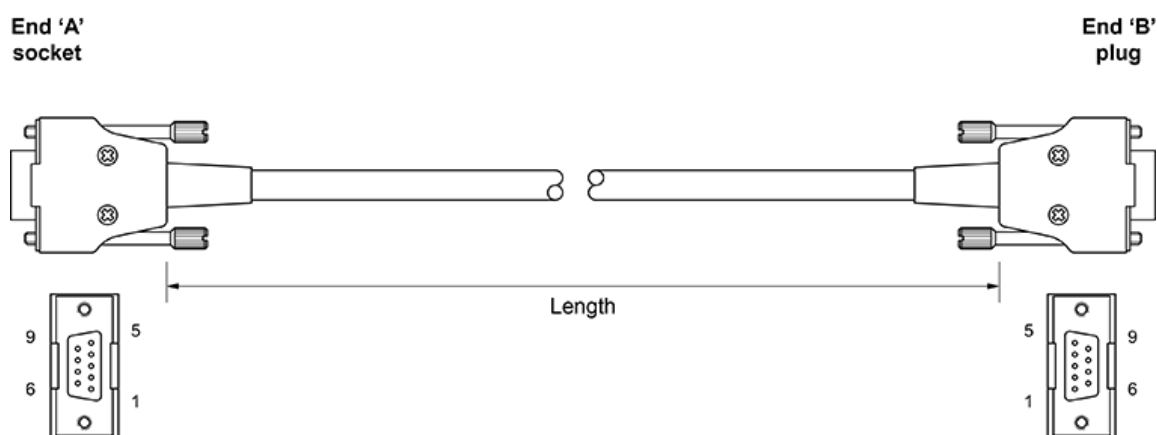

End 'A' and 'B'	Wire	MCU1 signal
1	Yellow	Ground
2	Grey	Rx (receive) B
3	Pink	RX (receive) A
4	Blue	TX (transmit) A
5	Not connected	Reserved
6	Green	+15 V
7	Brown	TX (transmit) B
8	White	E-STOP B
9	Red	E-STOP A
Shell	Screen	Screen

CMM cable guide

www.renishaw.com

PL172 PHC10-3 three-way linking cable

Cable name	Part number
PL172	A-5684-1000

This cable is used to combine a multiwire system with a standard touch-trigger probe system using the PHC10-3 7-pin DIN raw probe input connector, without the need for an IS1-2 interface selector to route signals.

End 'A'

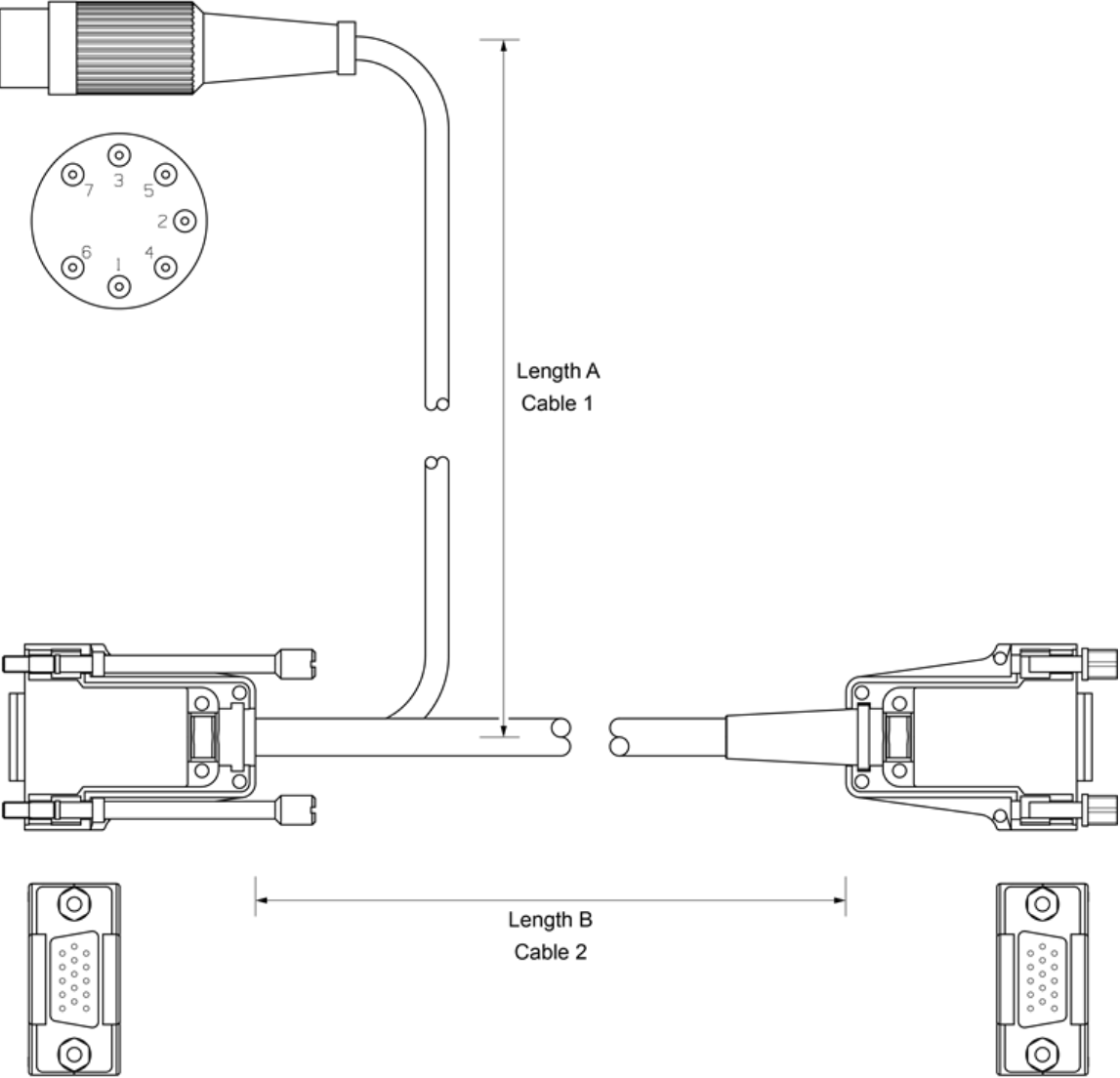

End 'B'

End 'C'

CMM cable guide

www.renishaw.com

End 'B'	Wire	End 'A' and 'C'
1	White / brown stripe	C1
3	Black (cable 2)	A4 - Black (cable 1) C3
4	Red	C4
5	Orange	C5
6	Grey	C6
7	White	C7
8	White / black stripe	C8
9	Co-axial outer	C9
10	Co-axial core	C10
11	Violet	C11
12	Blue	C12
14	Green	C14
15	Yellow	C15
		A5 - Brown (cable 1)
		C13 - Brown (cable 2)

CMM cable guide

www.renishaw.com

PLM6 and PLM7 machine cables

Cable name	Part number	Length
PLM6	A-1016-7564	6 m (236.22 in)
PLM7	A-1016-7563	4 m (157.48 in)

These two straight cables each have a 15-pin D-type plug at end 'A' and a 14-pin chassis-mount LEMO socket supplied loose for fitment to end 'B'. They reside within the CMM axis conduits and link with the probe head cables to relay the motorised probe head and controller signals.

These are also used to link with adaptor cables and relay SP80 scanning probe signals to and from Renishaw controllers or equivalent counter cards via an IU80 interpolator unit.

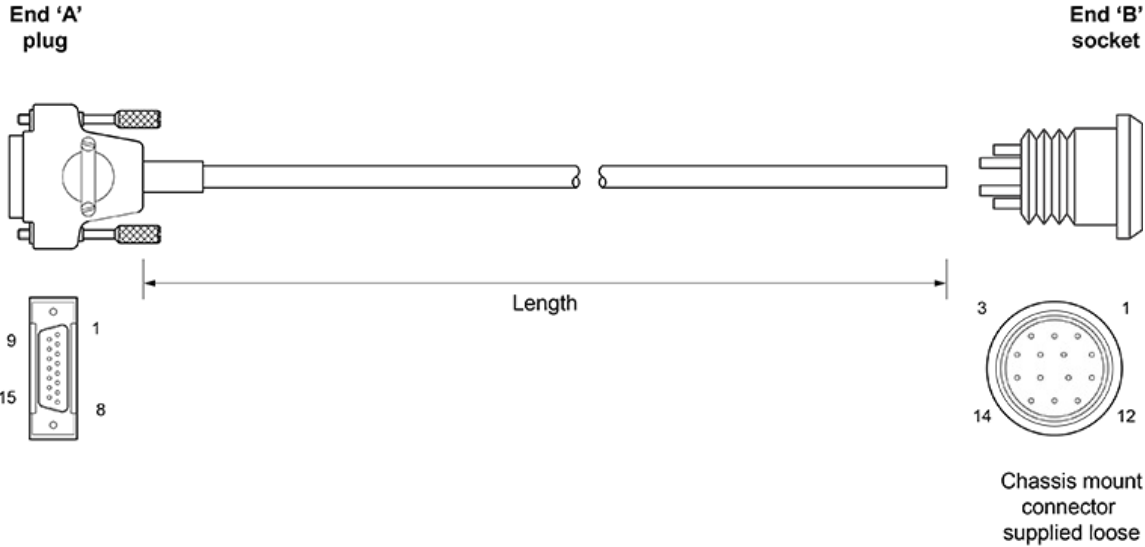

CMM cable guide

www.renishaw.com

End 'A'	End 'B'	Wire	Signal
1	2	Brown	Ground sense
2	7	Turquoise	Head present
3	12	Yellow	A axis feedback
4	4	Green / red	Ground 0 V
5	14	Grey	Motor probe switch
6	3	Violet	DC reference 12 V
7	9	Pink	B axis motor / probe contact
8	13	Blue	LED and datum
-	-	-	-
10	5	Green	Locking motor 8 V dc nominal
11	8	White	A axis motor 12 V dc nominal
12	6	Red	A axis motor 12 V dc nominal
-	-	-	-
14	2	Black	B axis
15	10	Orange	B axis motor / probe contact
'A' body	11*	Braid	Screen



*** NOTE:** Separate 7 to 14 strands of braid and cover with sleeving, connect to end 'B' pin 11. Separate remaining strands and trap evenly under collet and split insert carrier.

CMM cable guide

www.renishaw.com

PLM8 and PLM9 machine cables

Cable name	Part number	Length
PLM8	A-1016-7677	6 m (236.22 in)
PLM9	A-1016-7678	4 m (157.48 in)

These two straight cables each have a 15-pin D-type plug at end 'A' and a 14-pin in-line LEMO socket at end 'B'. They reside within the CMM axis conduits and link with the probe head cables to relay the motorised probe head and controller signals.

These are also used to link with adaptor cables and relay SP80 scanning probe signals to and from Renishaw controllers or equivalent counter cards via an IU80 interpolator unit.

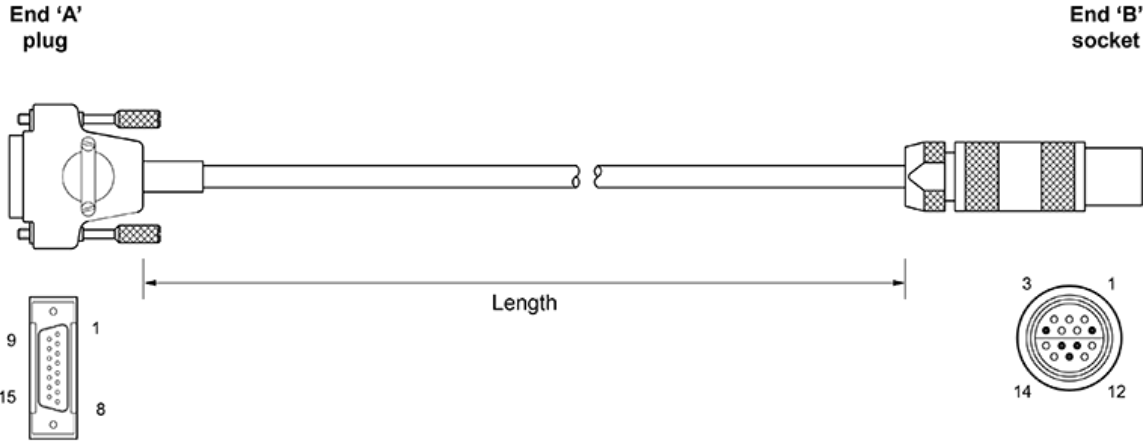

CMM cable guide

www.renishaw.com

End 'A'	End 'B'	Wire	Signal
1	2	Brown	Ground sense
2	7	Turquoise	Head present
3	12	Yellow	A axis feedback
4	4	Green / red	Ground 0 V
5	14	Grey	Motor probe switch
6	3	Violet	DC reference 12 V
7	9	Pink	B axis motor / probe contact
8	13	Blue	LED and datum
-	-	-	-
10	5	Green	Locking motor 8 V dc nominal
11	8	White	A axis motor 12 V dc nominal
12	6	Red	A axis motor 12 V dc nominal
-	-	-	-
14	1	Black	B axis
15	10	Orange	B axis motor / probe contact
'A' body	11*	Braid	Screen



*** NOTE:** Separate 7 to 14 strands of braid and cover with sleeving, connect to end 'B' pin 11. Separate remaining strands and trap evenly under collet and split insert carrier.

CMM cable guide

www.renishaw.com

SPA2 to UCC2 emergency stop cable

Part number	Length
A-5121-0062	750 mm (29.53 in)

This straight cable has a 9-pin D-type plug at end 'A' and a 25-pin D-type plug at end 'B'. It is used to relay emergency stop (E-STOP) signals between the SPA2 servo power amplifier and UCC2 universal controller.

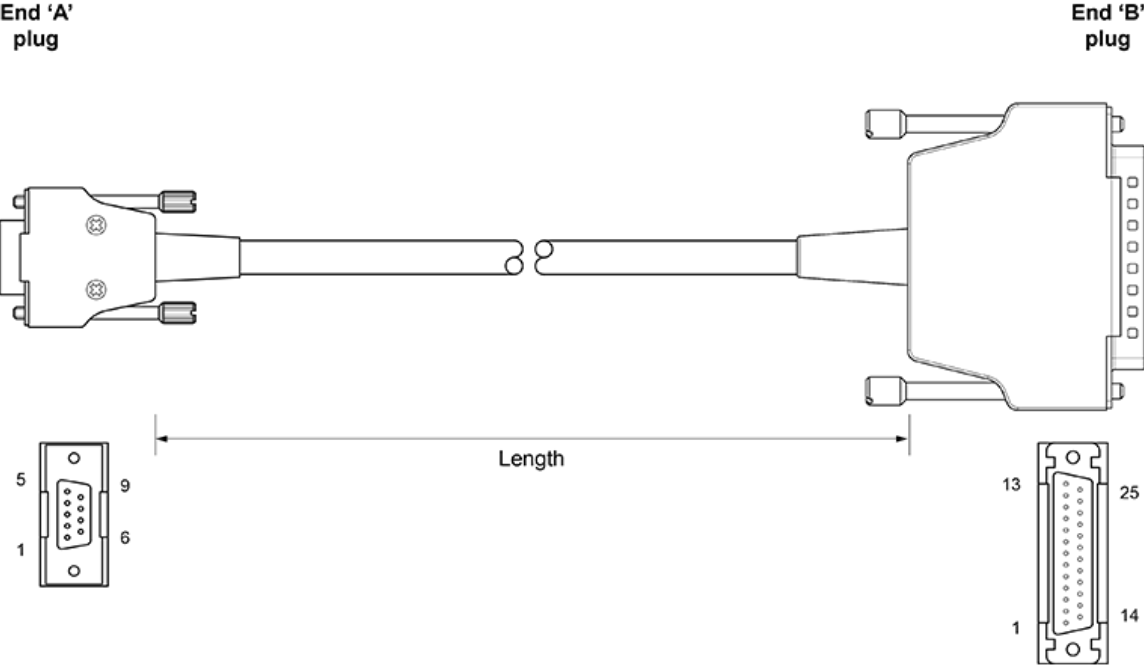

End 'A'	End 'B'	Signal
3	25	Ground 24 V
6	6	E-STOP 'A'
7	7	E-STOP 'B'
8	4	Engage
9	3	E-STOP 'C'
Shell	Screen	Shell

CMM cable guide

www.renishaw.com

UCC2 to SPA2 communication cable

Part number	Length
P-CA78-0017	1 m (39.37 in)

This straight Ethernet cable has RJ45 type plugs that are connected pin-to-pin at each end. Each UCC2 and SPA2 installation requires two of these cables (normally supplied) for signal communication between the units.

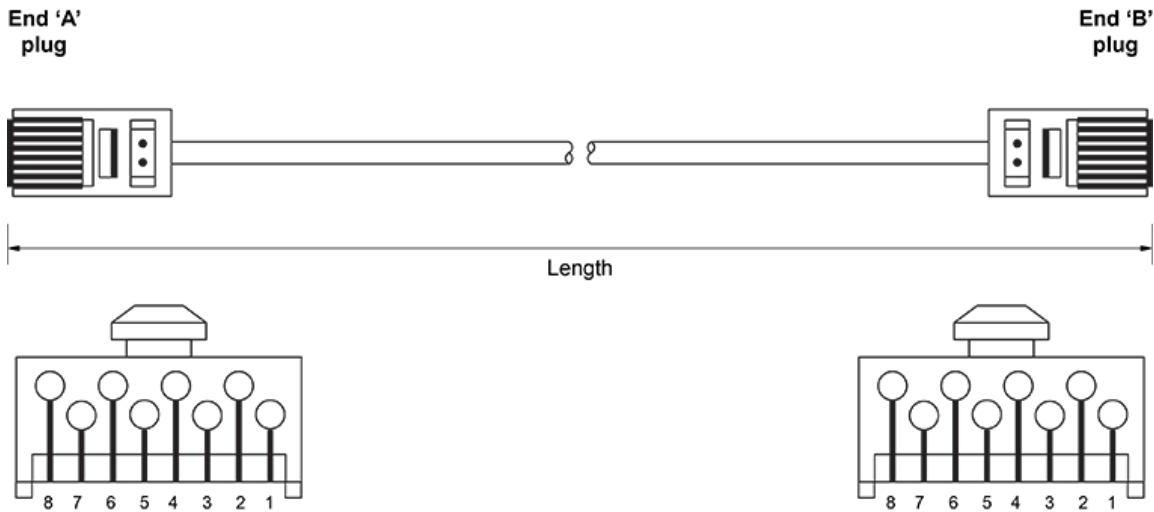

End 'A' and 'B'	Wire
1	Orange / white
16	Orange
17	Green / white
18	Blue
19	Blue / white
20	Green
21	Brown / white
22	Brown

CMM cable guide

www.renishaw.com

UCC2 to SPA2 6th axis cable

Part number	Length
P-CA82-0013	360 mm (14.17 in)

This straight Ethernet cable has RJ45 type plugs that are connected pin-to-pin at each end. Each 6th axis installation requires one of these cables for the additional signal communications between units.

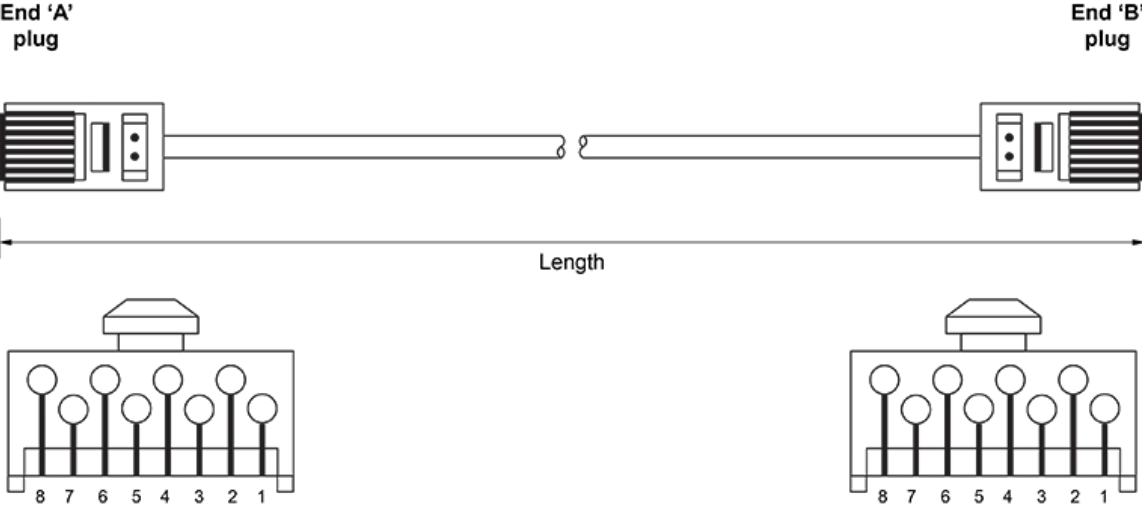

End 'A' and 'B'	Wire
1	Orange / white
9	Orange
10	Green / white
11	Blue
12	Blue / white
13	Green
14	Brown / white
15	Brown

CMM cable guide

www.renishaw.com

CMM PC to UCC2 communications cable

Part number	Length
P-CA81-0002	5 m (196.85 in)

This straight Ethernet cable has RJ45 type plugs that electrically 'cross-over' at each end, therefore they are NOT pin-to-pin. One of these cables is required for communication between the CMM PC and the UCC2 controller.

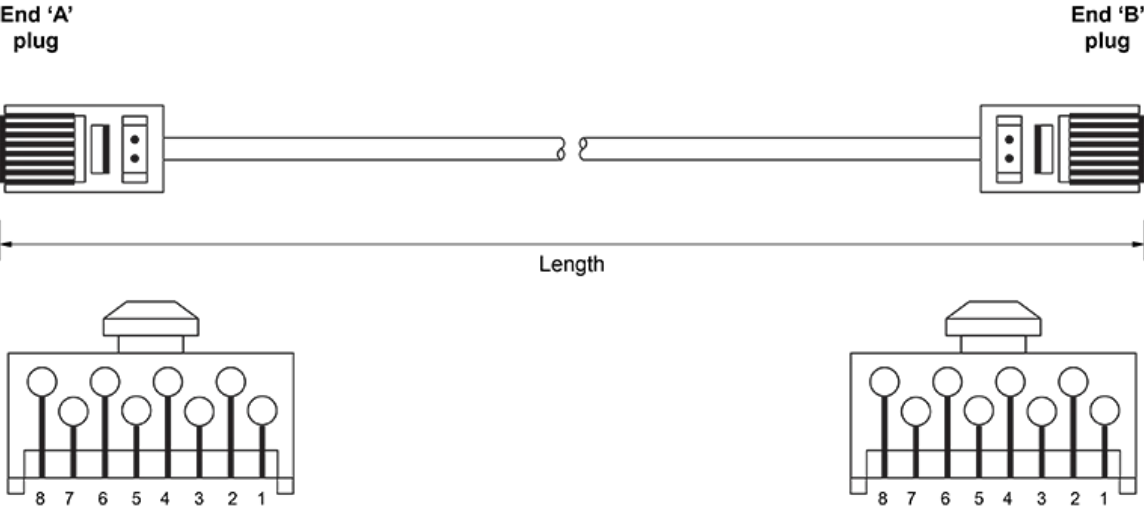

End 'A'	Wire	End 'B'
1	Light green	3
2	Green	6
3	White	1
4	Blue	4
5	Light blue	5
6	Orange	2
7	Light brown	7
8	Brown	8

CMM cable guide

www.renishaw.com

Scale adaptor cable

Part number	Length
A-1333-0183	260 mm (10.24 in)

This straight cable has a 15-pin D-type socket at end 'A' and has a 15-pin high-density D-type plug at end 'B'. This custom product cable is used where scale interpolators are connected or where machine cabling is compatible for its use.

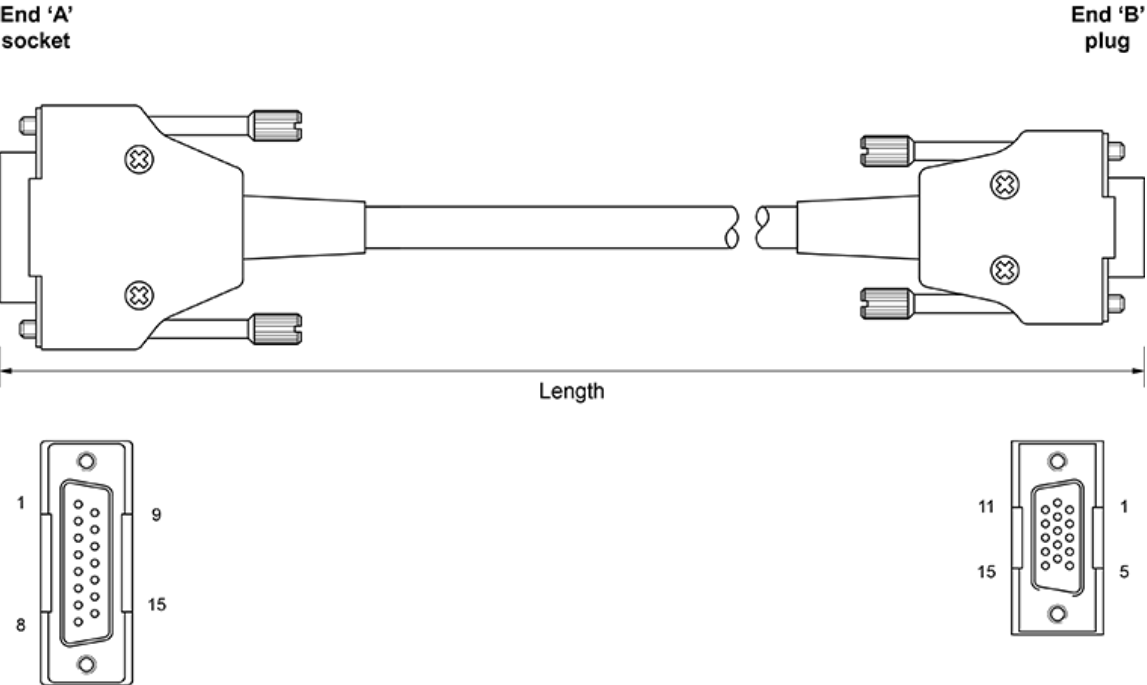

End 'A' and 'B'	Wire	End 'A' and 'B'	Wire
1	Red	9	Orange
2	Blue	10	Pink
3	Green	11	Turquoise
4	Yellow	12	Grey
5	White	13	Red / blue
6	Black	14	Red / green
7	Brown	15	Red / yellow
8	Violet	Shell	Outer screen

CMM cable guide

www.renishaw.com

PHC10 to UCC RS232 comms cable

Part number	Length
A-5567-1622	50 cm (19.7 in)

This straight cable has a 25-pin D-type socket at end 'A' and a 9-pin D-type socket at end 'B'. It is used to connect PHC10 to UCC.

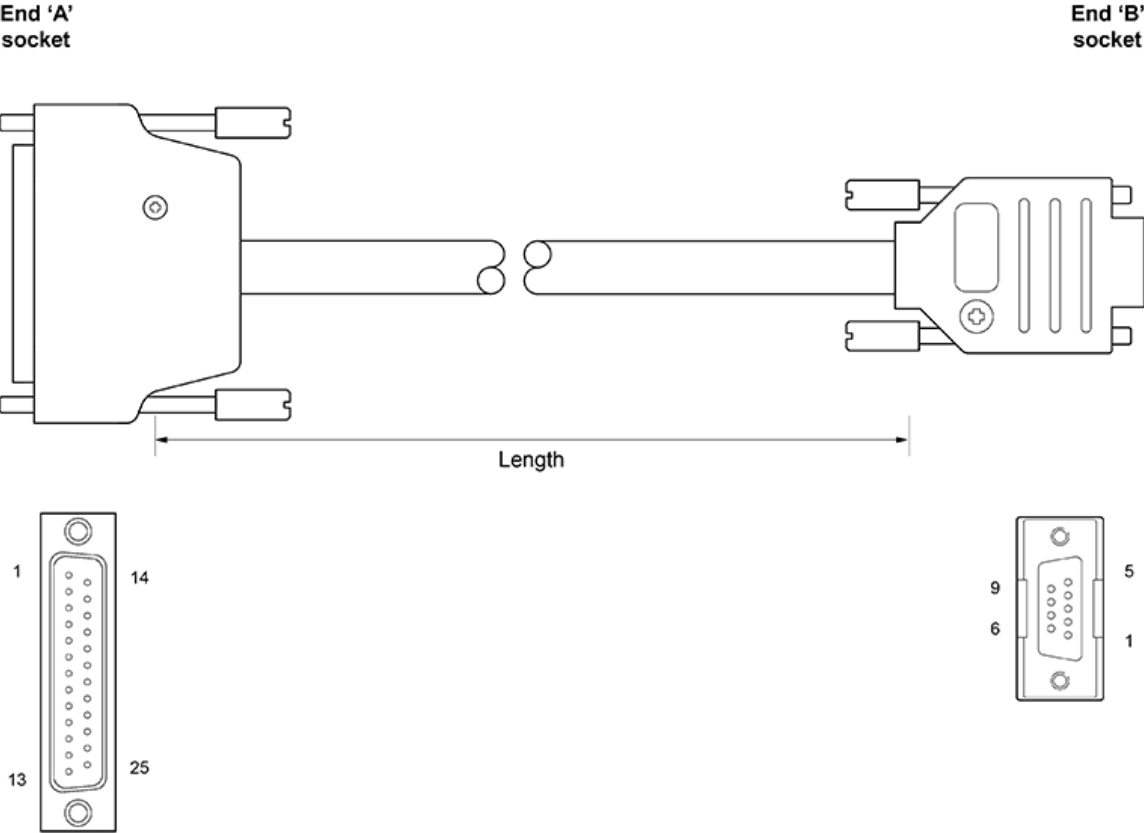

End 'A'	End 'B'	Wire	Signal
2	2	White	TX-RX
3	3	Red	RX-TX
4	8	Green	RTS-CTS
5	7	Orange	CTS-RTS
7	5	Black	Ground
Backshell	Backshell	Screen	Screen

CMM cable guide

www.renishaw.com

Dual SPA3 E-STOP cable assembly and external E-STOP

Part number	Length 1	Length 2
A-5629-0090	50 cm (19.7 in)	17 cm (6.7 in)

This straight cable has a 25-pin D-type plug at end 'A', a 9-pin D-type socket at end 'B', a 9-pin D-type socket at end 'C' and a 9-pin D-type plug at end 'D'. It is used to connect two SPA3s to UCC2, UCC2-2, UCC T3 PLUS, UCC T5 or UCC S3, and an external E-STOP.

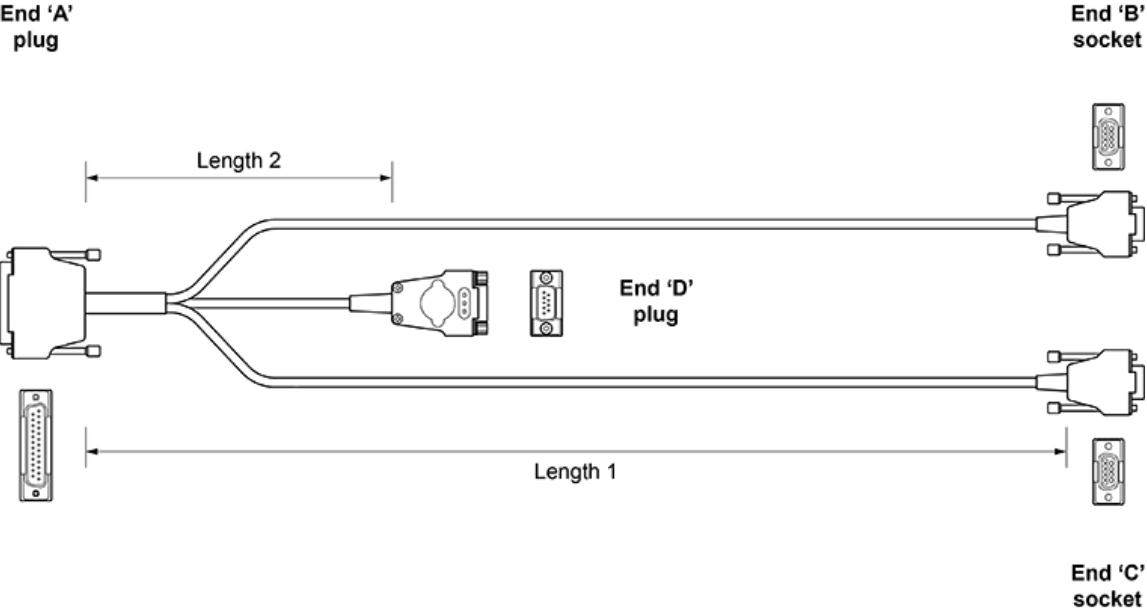

CMM cable guide

www.renishaw.com

End 'A' UCC2 25W D plug PCB	Colour	Signal	End 'B' SPA3 (M) 9W D socket	End 'C' SPA3 (S) 9W D socket	End 'D' External E-STOP 9W D plug
1	White	A2	6	-	-
2	Green	Reset	9	-	-
2	Green	Reset	-	9	-
2	Green	Reset B	-	-	9
3	Grey	B1	4	-	-
3	Grey	B1	-	4	-
3	Yellow	B2	7	-	-
3	Yellow	B2	-	7	-
3	Yellow	Reset A	-	-	5
4	White	E-STOP A	-	-	6
5	Brown	E-STOP B	-	-	7
6	Brown	GND	3	-	-
6	Brown	GND	-	3	-

CMM cable guide

www.renishaw.com

High power option E-STOP cable

Part number	Length 1	Length 2
A-5208-0011	97 cm (38.2 in)	76 cm (29.9 in)

This straight cable has a 25-pin D-type plug at end 'A' and a 9-pin D-type plug at ends 'B' and 'C'. It is used to connect two SPA2-2s to a UCC2-2 controller.

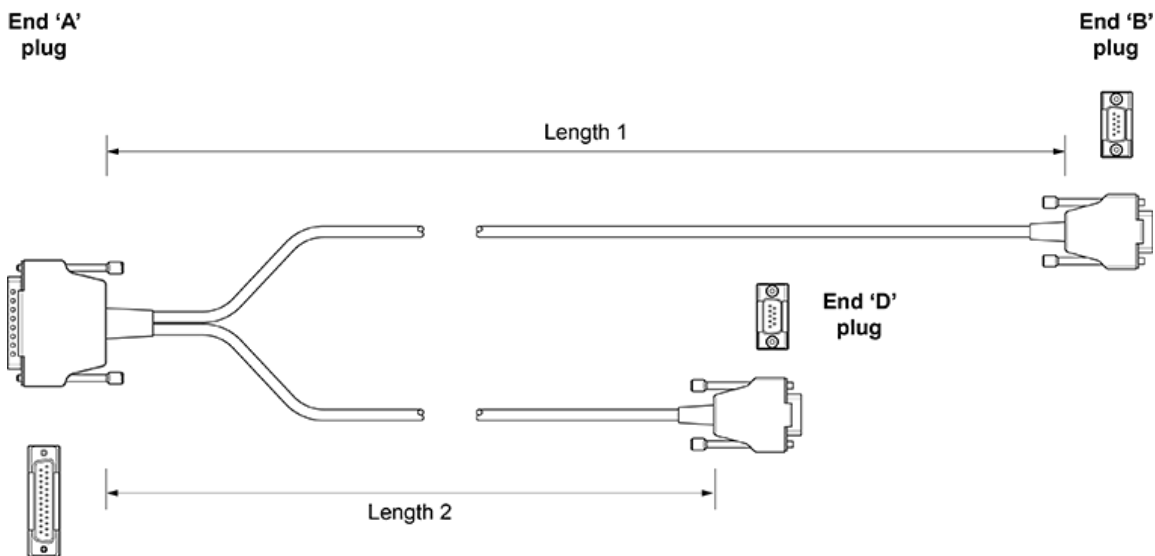

End 'A' 25W D	Colour	Signal	End 'B' 9W D	End 'C' 9W D
25	Grey	GND 24 V	3	3
6	Brown	E-STOP 'A';	6	n/c
7	Yellow	E-STOP 'B'	7	7
4	White	Engage	8	8
3	Green	E-STOP 'C'	9	9
Shell		Screen	Shell	Shell

CMM cable guide

www.renishaw.com

High-speed communications cable - crimped ends

Part number	Length
A-5669-0090	10 m (393.7 in)
A-5669-0091	15 m (590.6 in)
A-5669-0092	20 m (787.4 in)
A-5669-0093	25 m (984.3 in)

These straight cables are pre-crimped for easy fitment to the 15-pin high-density D-type socket at end 'A' and a 15-pin D-type plug at end 'B'. They are used to connect REVO-2 or PH20 to the controller.

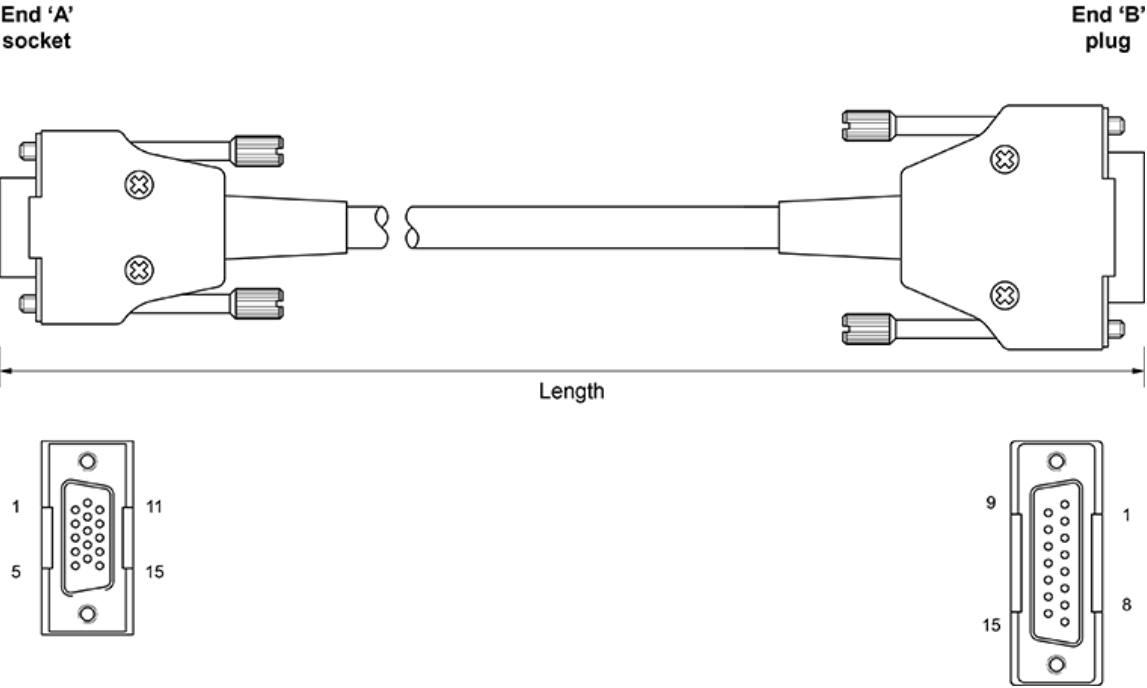

CMM cable guide

www.renishaw.com

Head end (15-way high-density 'D' socket) pin number	Colour	Controller end (15-way 'D' plug) pin number
1	Orange	3
2	Black	2
3	Red	6
4	Grey	7
5	Brown	15
6	Orange / black	11
7	White	4
8	Clear	12
9	Green / yellow	9
10	Pink	8
11	Green	1
12	Green / black	10
13	Blue	5
14	Violet	13
15	Yellow	14
Shell	Screen	Shell

CMM cable guide

www.renishaw.com

High-speed communications cable (orange)

Part number	Length
A-5669-0015	15 m (590.1 in)
A-5759-0025	25 m (984.3 in)

This straight cable has a 15-pin high-density D-type socket at end 'A' and a 15-pin D-type plug at end 'B'. It is used to connect REVO-2 or PH20 to the controller.

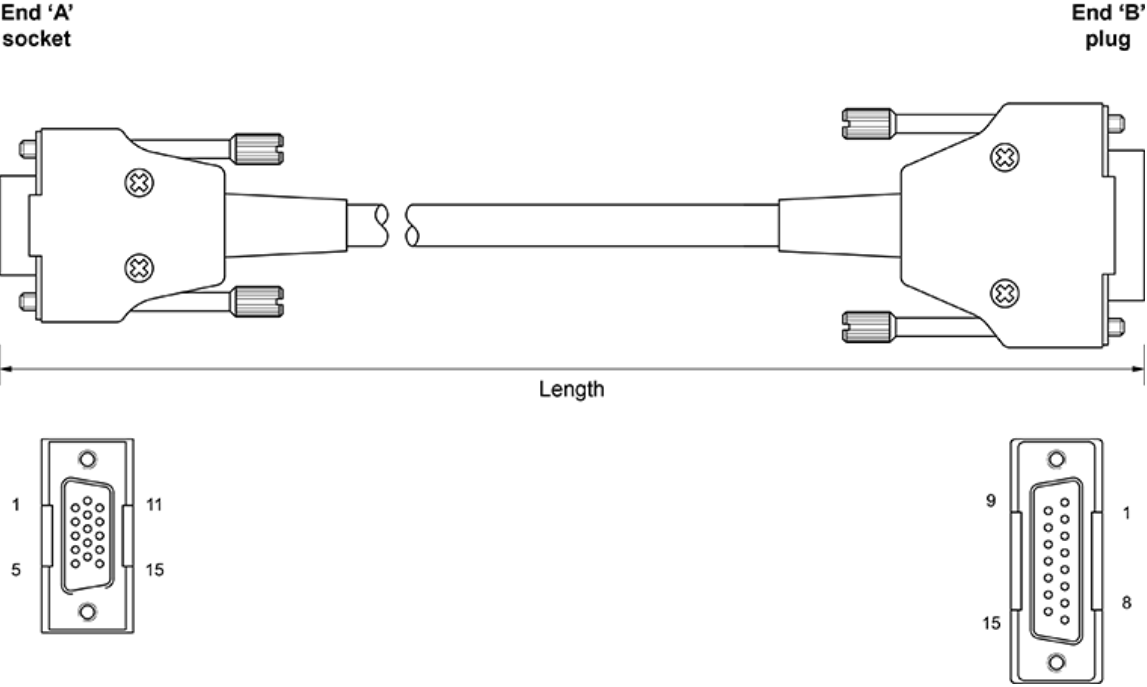

CMM cable guide

www.renishaw.com

Head end (15-way high-density 'D' socket) pin number	Colour	Controller end (15-way 'D' plug) pin number
1	Orange	3
2	Black	2
3	Red	6
4	Grey	7
5	Brown	15
6	Orange / black	11
7	White	4
8	Clear	12
9	Green / yellow	9
10	Pink	8
11	Green	1
12	Green / black	10
13	Blue	5
14	Violet	13
15	Yellow	14
Shell	Screen	Shell

CMM cable guide

www.renishaw.com

High speed communications cable - cable only

Part number	Length
A-5669-0045	250 m
A-5759-0050	500 m

This straight cable is used to connect REVO or PH20 to the controller. It is supplied by the drum to be cut to length as required.

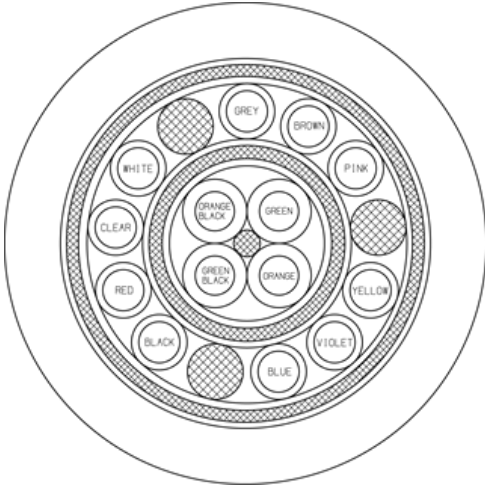

Minimum bend radius / life

Static:	30 mm
Dynamic:	40 mm / 1,000,000 cycles

CMM cable guide

www.renishaw.com

Ethernet controller cable

Part number	Length
A-5629-0071	30 cm (11.8 in)

This ethernet cable is used to connect UCC2 and SPA3.

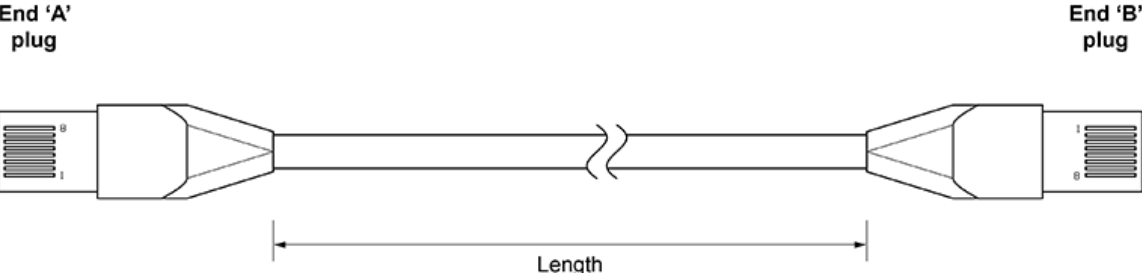

Pair	P1 (T568B)	Wire	P2 (T568B)
1	1	White / orange	1
1	2	Orange	2
2	3	White / green	3
2	6	Green	6
3	4	Blue	4
3	5	White / blue	5
4	7	White / brown	7
4	8	Brown	8

CMM cable guide

www.renishaw.com

Y-connector cables

This adaptor kit contains two Y-connector cables and is used to connect REVO-2 to two 'grey' REVO cables.

Head flex comms cable adaptor

Part number	Length 1	Length 2
A-3065-0150	230 cm (90.6 in)	140 cm (55.1 in)

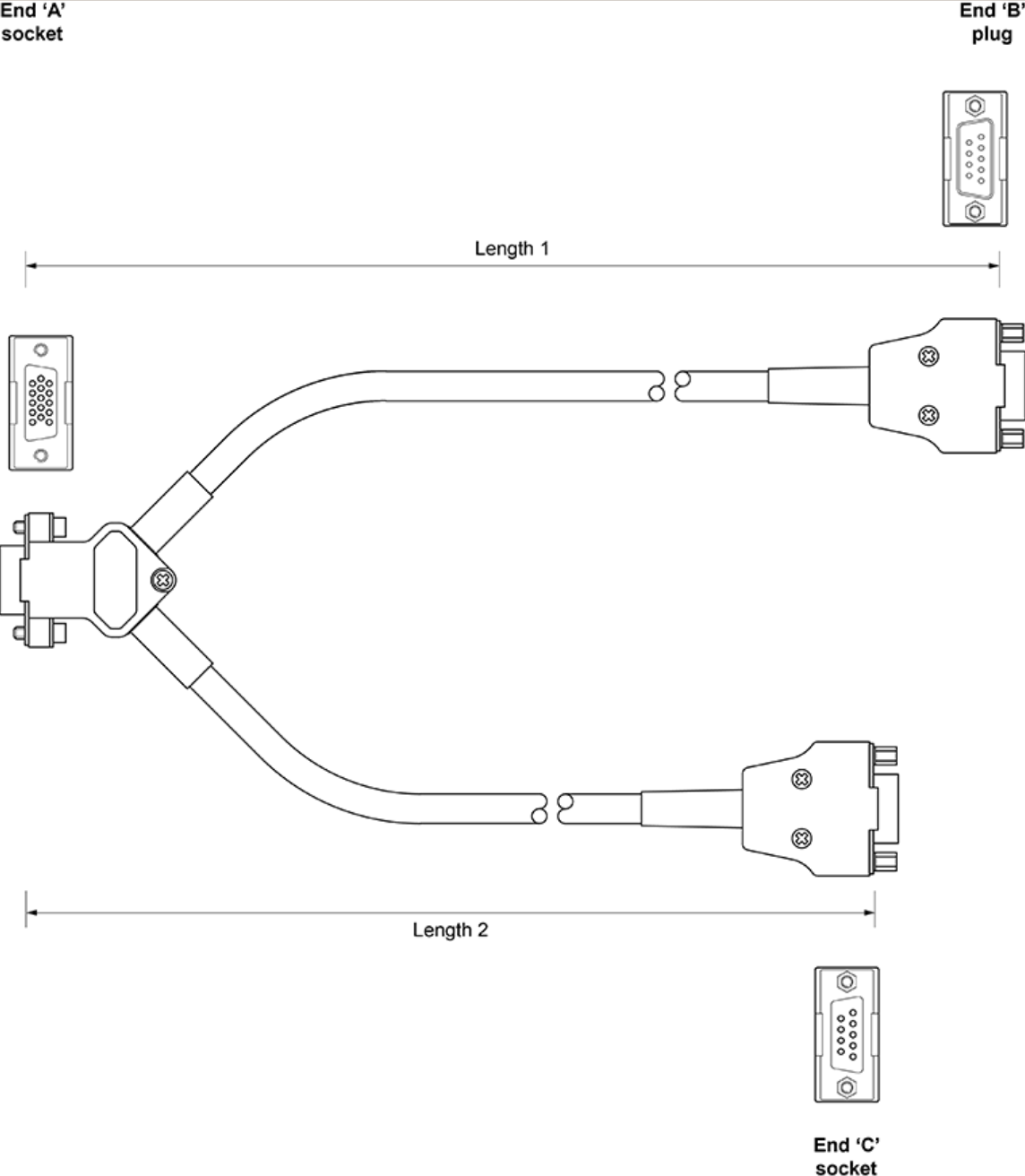

CMM cable guide

www.renishaw.com

Controller flex comms cable adaptor

Part number	Length
A-3065-0160	510 cm (200.79 in)

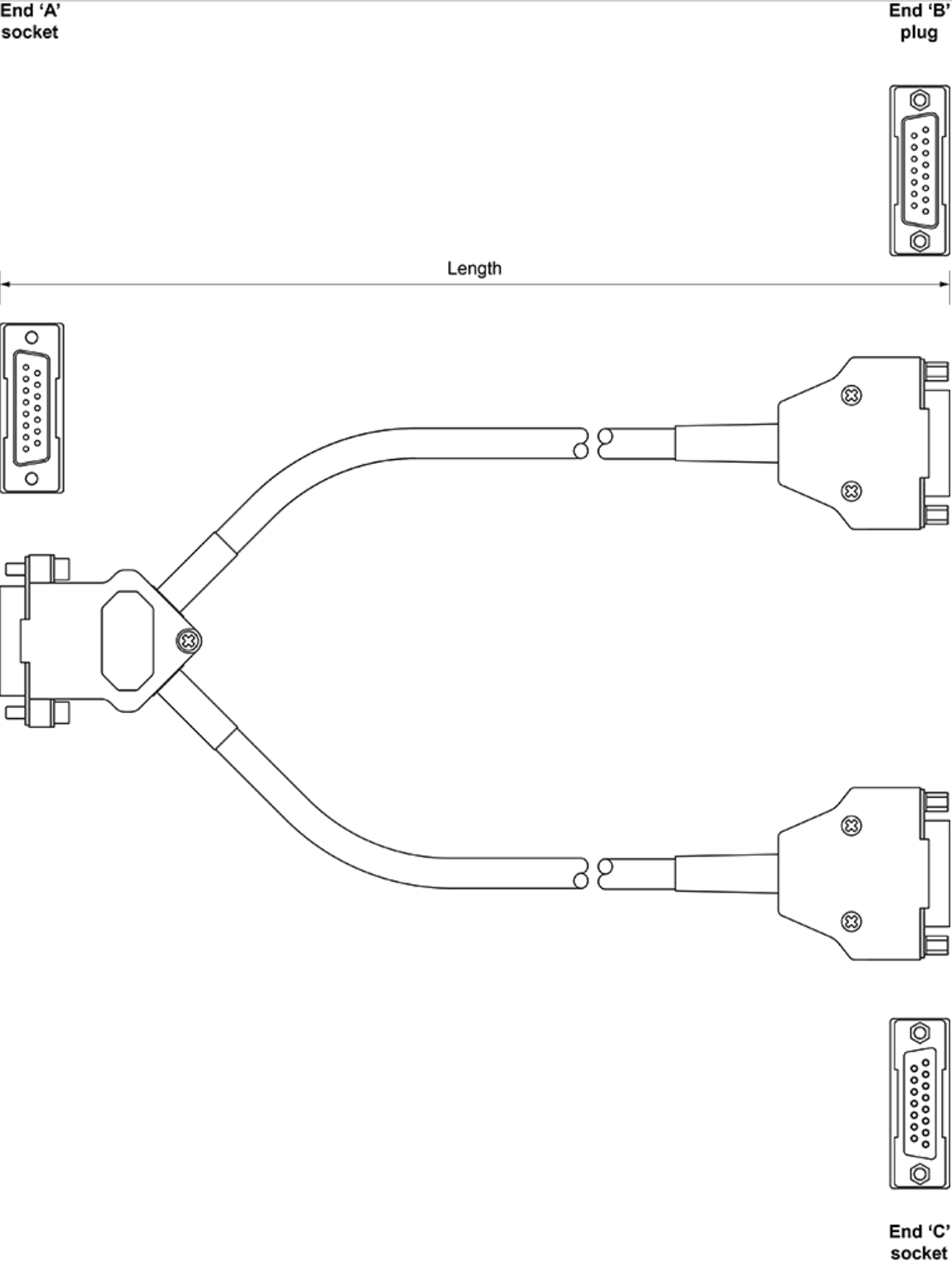

CMM cable guide

www.renishaw.com

End 'A'	Function	Colour	Cable
1	DOWNLINK +	Blue	POWER & COMMS
2	+ V	White	POWER & COMMS
3	UPLINK +	Green	POWER & COMMS
4	0 V	Black (white)	POWER & COMMS
5	D_MOTOR_0	Red	MOTOR
6	V +	Red	POWER & COMMS
7	E_MOTOR_2	Blue	MOTOR
8	E_MOTOR_1	Black (green)	MOTOR
9	INNER SHIELD	-	-
10	DOWNLINK -	Black (blue)	POWER & COMMS
11	UPLINK -	Black (green)	POWER & COMMS
12	V +	Black (red)	POWER & COMMS
13	D_MOTOR_1	Black (red)	MOTOR
14	D_MOTOR_2	White	MOTOR
15	E_MOTOR_0	Green	MOTOR
Shell	Chassis	Braided screen	BOTH CABLES

CMM cable guide

www.renishaw.com

Y-connector cables

This adaptor kit contains two Y-connector cables and is used to connect REVO(1) to a single orange high-speed communications cable.

REVO universal cable adaptor

Part number	Length
A-3065-0050	160 cm (62.99 in)

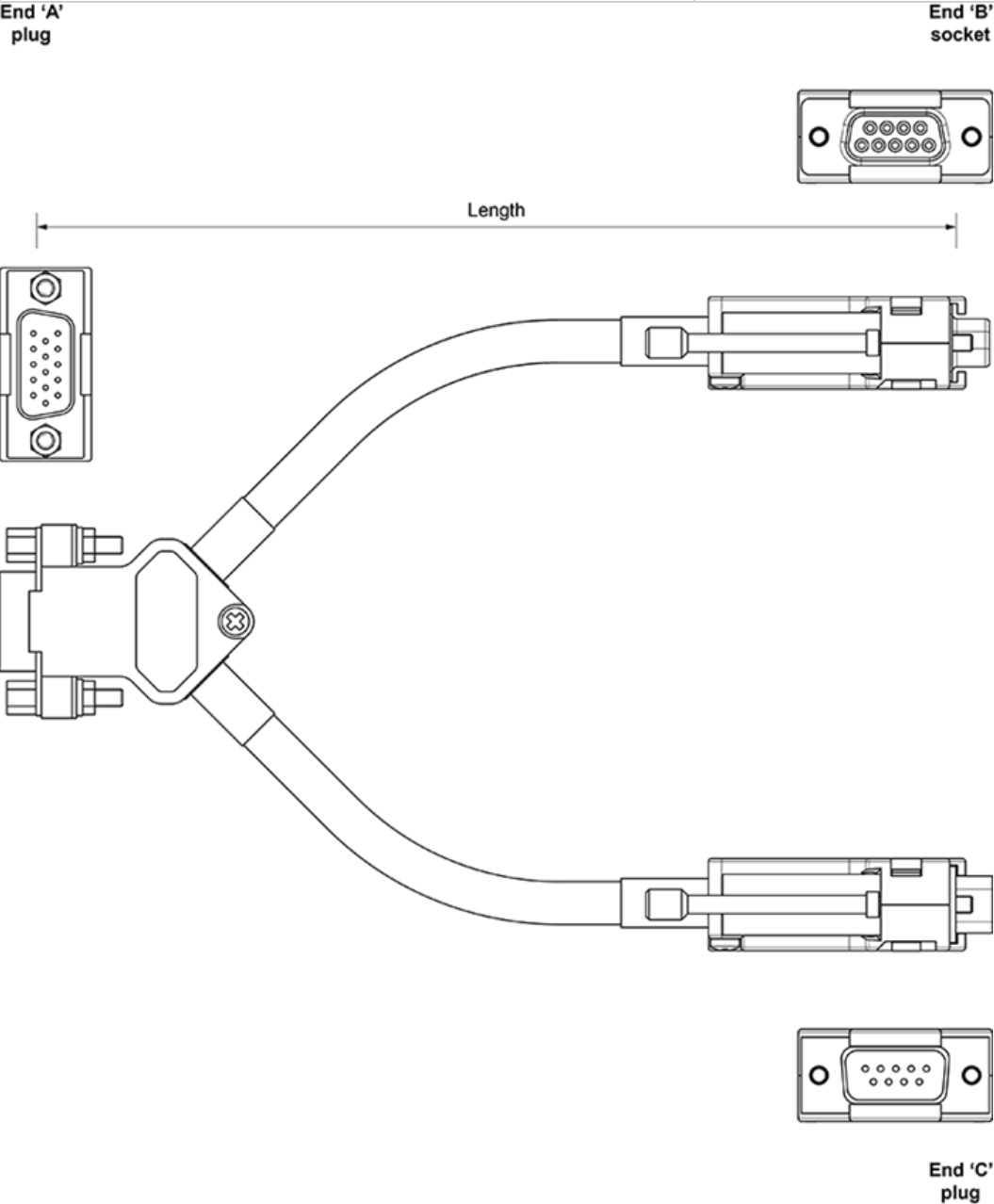

CMM cable guide

www.renishaw.com

PCI / SPA universal cable adaptor

Part number	Length
A-3065-0160	510 cm (200.79 in)

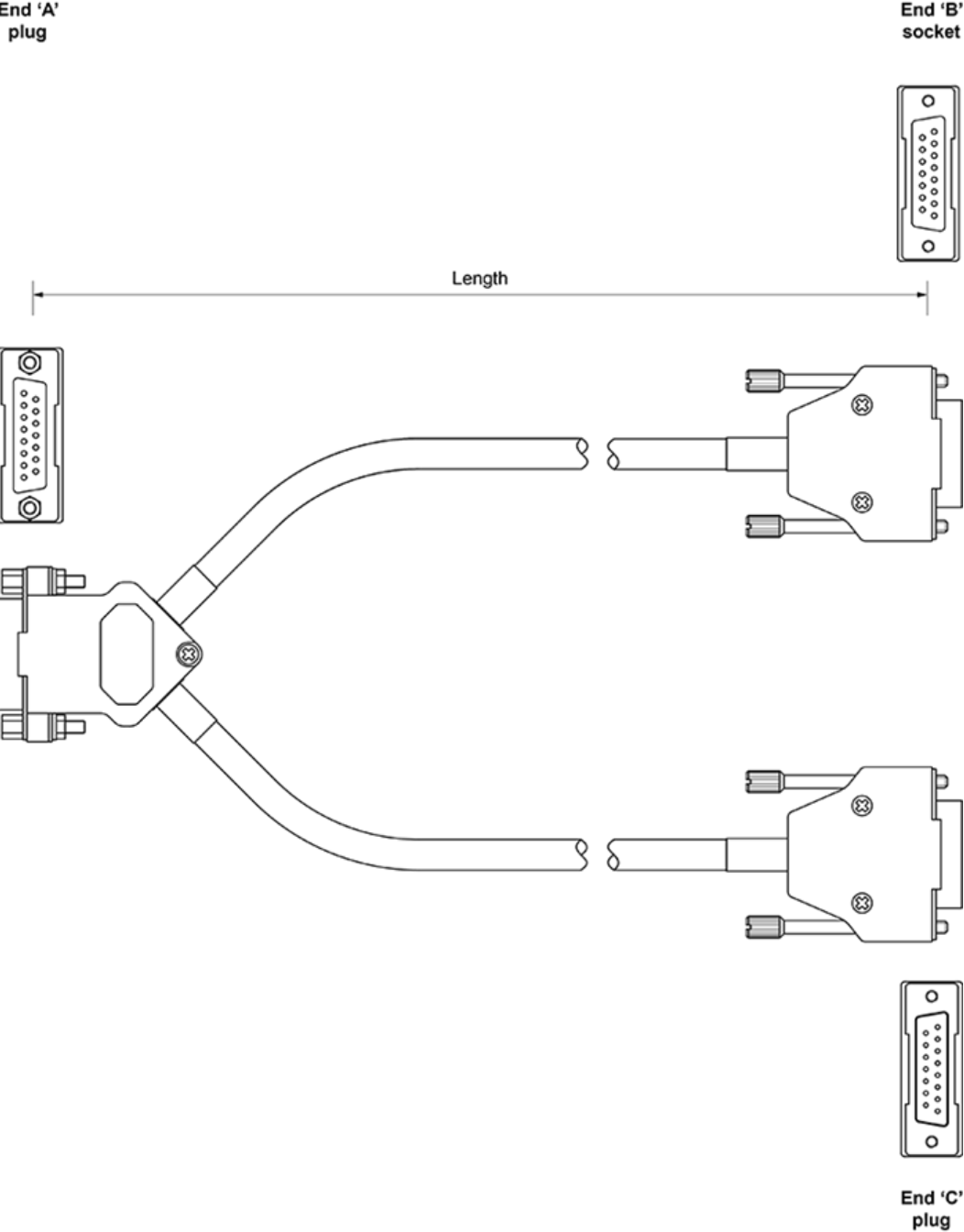

CMM cable guide

www.renishaw.com

End 'A'	Function	Colour	Cable
1	DOWNLINK +	Blue	POWER & COMMS
2	+ V	White	POWER & COMMS
3	UPLINK +	Green	POWER & COMMS
4	0 V	Black (white)	POWER & COMMS
5	D_MOTOR_0	Red	MOTOR
6	V +	Red	POWER & COMMS
7	E_MOTOR_2	Blue	MOTOR
8	E_MOTOR_1	Black (green)	MOTOR
9	INNER SHIELD	-	-
10	DOWNLINK -	Black (blue)	POWER & COMMS
11	UPLINK -	Black (green)	POWER & COMMS
12	V +	Black (red)	POWER & COMMS
13	D_MOTOR_1	Black (red)	MOTOR
14	D_MOTOR_2	White	MOTOR
15	E_MOTOR_0	Green	MOTOR
Shell	Chassis	Braided screen	BOTH CABLES

Renishaw plc
New Mills, Wotton-under-Edge
Gloucestershire, GL12 8JR
United Kingdom

T +44 (0)1453 524524
F +44 (0)1453 524901
www.renishaw.com/cmmsupport



**For worldwide contact details,
please visit our main website at
www.renishaw.com/contact**