

TONiC™ UHV encoder system

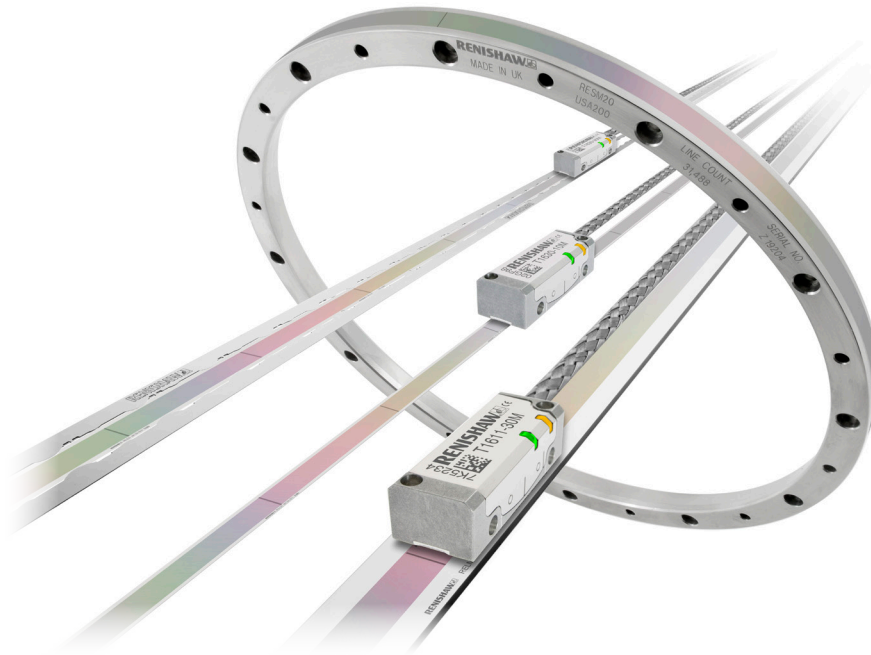

The TONiC UHV encoder offers all the benefits of the established TONiC linear and rotary encoder systems in a readhead that has been designed and constructed using ultra-high vacuum compatible materials and processes.

The TONiC UHV readhead is compatible with a wide range of linear and rotary scales with bi-directional optical *IN-TRAC*™ reference marks.

For ultimate reliability and high immunity to optical degradation, TONiC UHV readheads incorporate Renishaw's market-proven filtering optics, tuned for even lower noise (jitter), further enhanced by dynamic signal processing including Auto Gain Control (AGC) and Auto Offset Control (AOC). The result is ultra-low sub-divisional error (SDE) giving smoother velocity control for improved scanning performance and increased positional stability.



TONiC UHV readheads also feature a detachable analogue or digital interface in the form of a robust, convenient connector that can be located up to 10 m from the readhead. The interface offers digital interpolation to 1 nm resolution, with clocked outputs for optimised speed performance at all resolutions for industry-standard controllers.

The readhead carries an integral set-up LED that enables quick and easy installation. All of these readheads are supplied with an RFI-screened UHV-compatible cable as standard.

- Clean RGA
- Low outgassing rates
- High bake-out temperature of 120 °C
- Low power consumption readheads
- Non-contact open optical system
- Detachable analogue or digital connector with integral interpolation to 1 nm resolution (0.00075 arc seconds)
- Resolution to 1 nm
- Dynamic signal processing provides ultra-low SDE of typically ± 30 nm
- Auto Gain Control (AGC) ensures constant signal strength for long-term reliability
- Compatible with a wide range of linear and rotary scales with customer selectable *IN-TRAC* auto-phase optical reference mark (datum)

Compatible scales

Linear scales

| | RTL20-S Self-adhesive mounted stainless-steel tape scale | RTL20/FASTRACK™ Stainless-steel tape scale and self-adhesive mounted carrier | RKLC20-S Self-adhesive mounted stainless-steel tape scale |
|---|---|--|---|
| |  |  |  |
| Form (height x width) | 0.4 mm x 8 mm including adhesive | RTL20 scale: 0.2 mm x 8 mm FASTRACK carrier: 0.4 mm x 18 mm including adhesive | 0.15 mm x 6 mm including adhesive |
| Accuracy (includes slope and linearity) | ±5 µm/m | ±5 µm/m | ±5 µm/m |
| Linearity (figures achievable with two-point error correction) | ±2.5 µm/m | ±2.5 µm/m | ±2.5 µm/m |
| Maximum length | 10 m ¹ (> 10 m available on request) | 10 m (> 10 m available on request) | 20 m (> 20 m available on request) |
| Coefficient of thermal expansion (at 20 °C) | 10.1 ±0.2 µm/m/°C | 10.1 ±0.2 µm/m/°C | Matches that of substrate material when scale ends rigidly fixed ² |

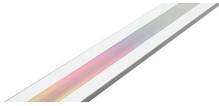
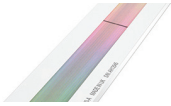

| | RSLM20 Self-adhesive or clip/clamp mounted stainless-steel spar scale | RELM20 Self-adhesive or clip/clamp mounted low-expansion ZeroMet™ spar scale |
|---|---|--|
| |  |  |
| Form (height x width) | 1.5 mm x 14.9 mm | 1.6 mm x 14.9 mm |
| Accuracy (includes slope and linearity) | ±4 µm (total accuracy over a complete 5 m length) | ±1 µm (total accuracy up to 1 m) |
| Linearity (figures achievable with two-point error correction) | N/A | N/A |
| Maximum length | 5 m | 1.5 m |
| Coefficient of thermal expansion (at 20 °C) | 10.1 ±0.2 µm/m/°C | 0.75 ±0.35 µm/m/°C |

NOTE: For more information about the scales refer to the relevant scale data sheet which can be downloaded from www.renishaw.com/tonicdownloads.

¹ For RTL20-S axis lengths > 2 m, FASTRACK with RTL20 is recommended.

² Scale mastering is not guaranteed after system bake-out.

Rotary scales

| | RESM20 | REXM20 |
|--|--|--|
| | Stainless-steel ring | Ultra-high accuracy stainless-steel ring |
| |  |  |
| Accuracy | ±1.9 arc second (typical installed accuracy for a 550 mm diameter RESM20 ring) ¹ | ±1 arc second ² (total installed accuracy for a 417 mm diameter REXM20 ring) |
| Ring diameters | 52 mm to 550 mm | 52 mm to 417 mm |
| Coefficient of thermal expansion (at 20 °C) | 15.5 ±0.5 µm/m/°C | 15.5 ±0.5 µm/m/°C |

NOTE: For more information about the scales refer to the relevant scale data sheet which can be downloaded from www.renishaw.com/tonicdownloads.

¹ "Typical" installations are a result of graduation and installation errors combining and, to some magnitude, cancelling.

² When using two readheads and an additional DSi interface.

TONiC readhead installation drawing (on RTLC20-S scale)



Dimensions and tolerances in mm

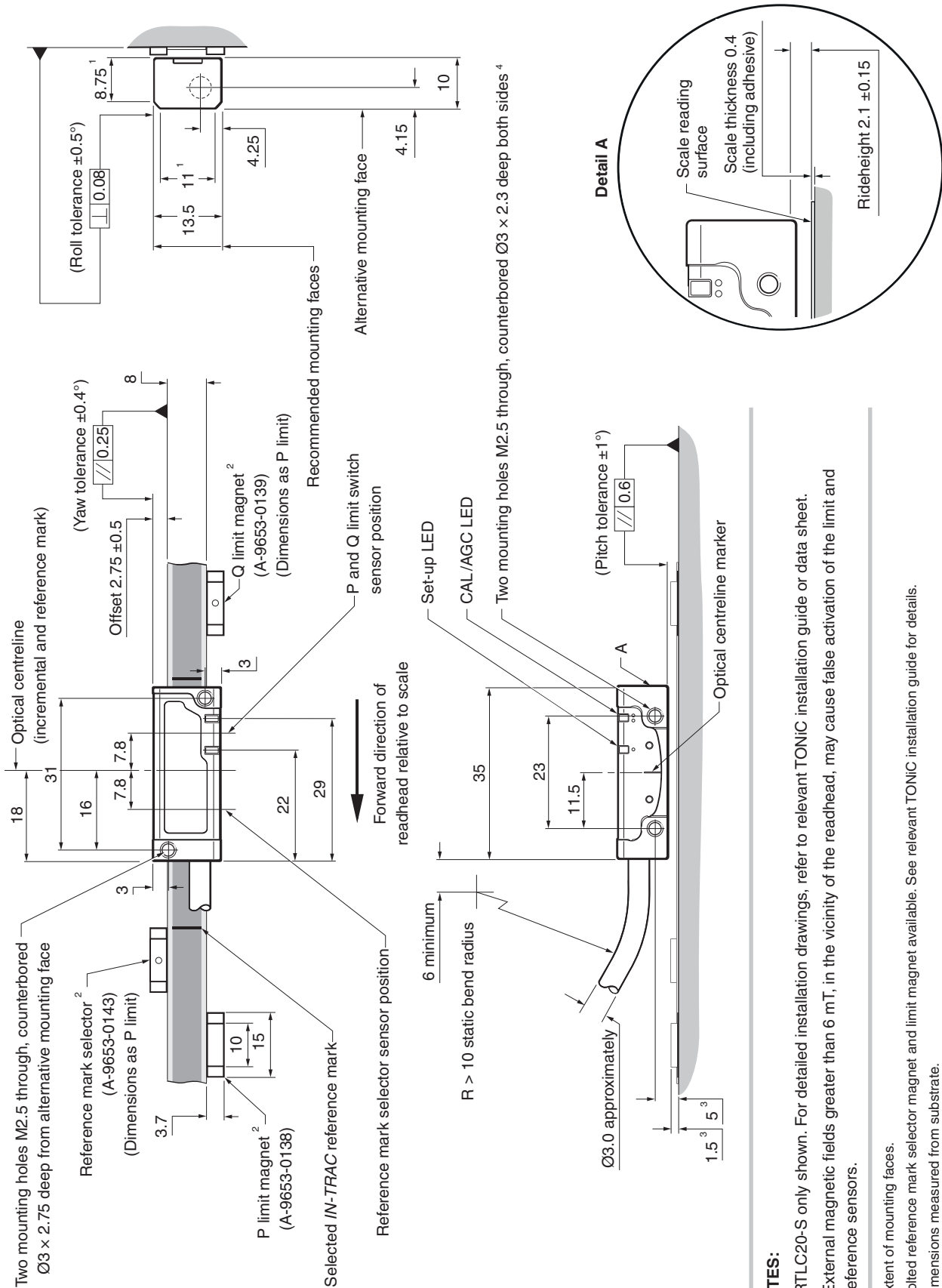

TONiC readhead installation drawing (on RESM20 ring)



Dimensions and tolerances in mm

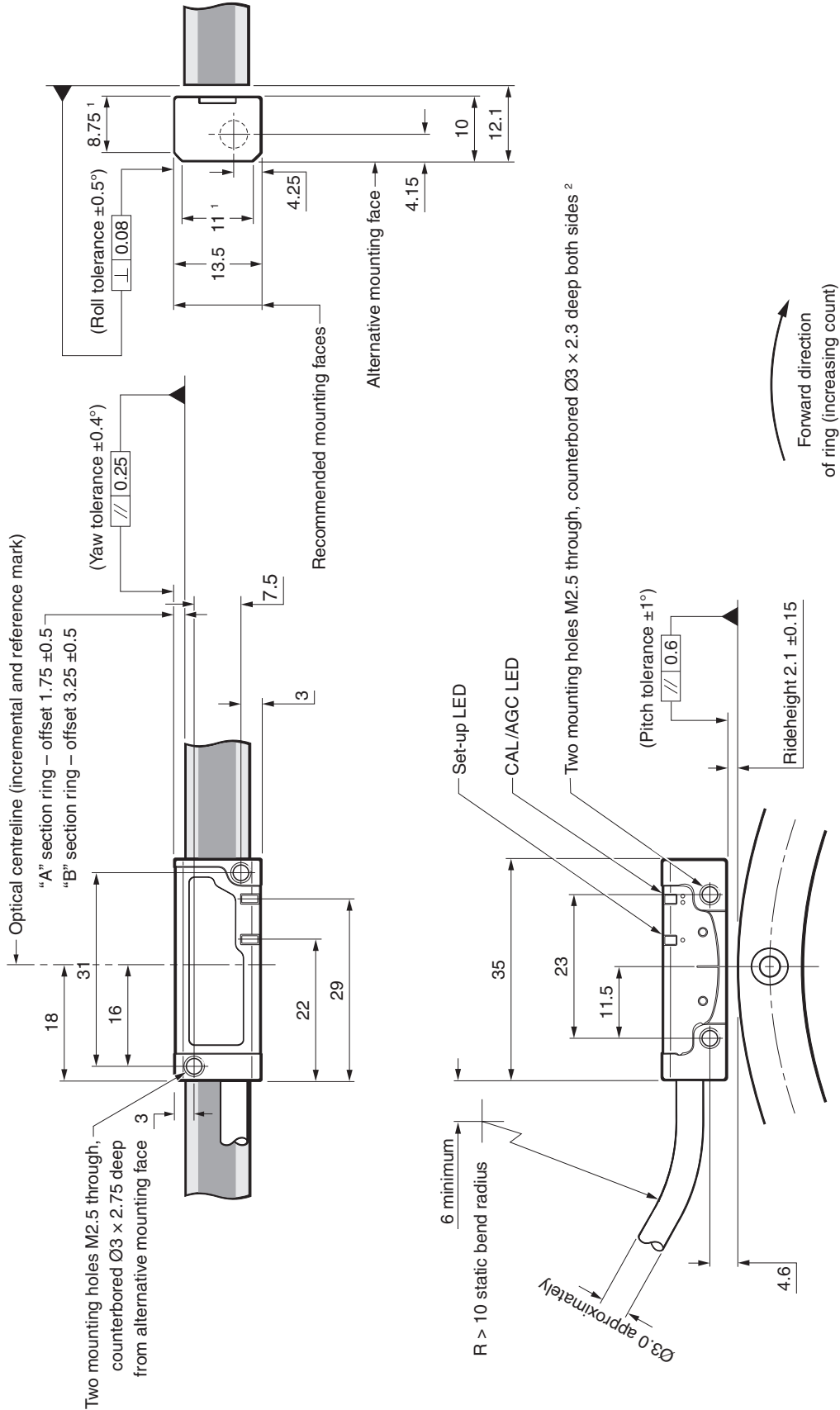

NOTE: External magnetic fields greater than 6 mT, in the vicinity of the readhead, may cause false activation of the limit sensor.

¹ Extent of mounting faces.

² The recommended thread engagement is 5 min (7.5 including counterbore). The recommended tightening torque is between 0.25 and 0.4 Nm.

Ti/TD interface dimension drawing



Dimensions and tolerances in mm

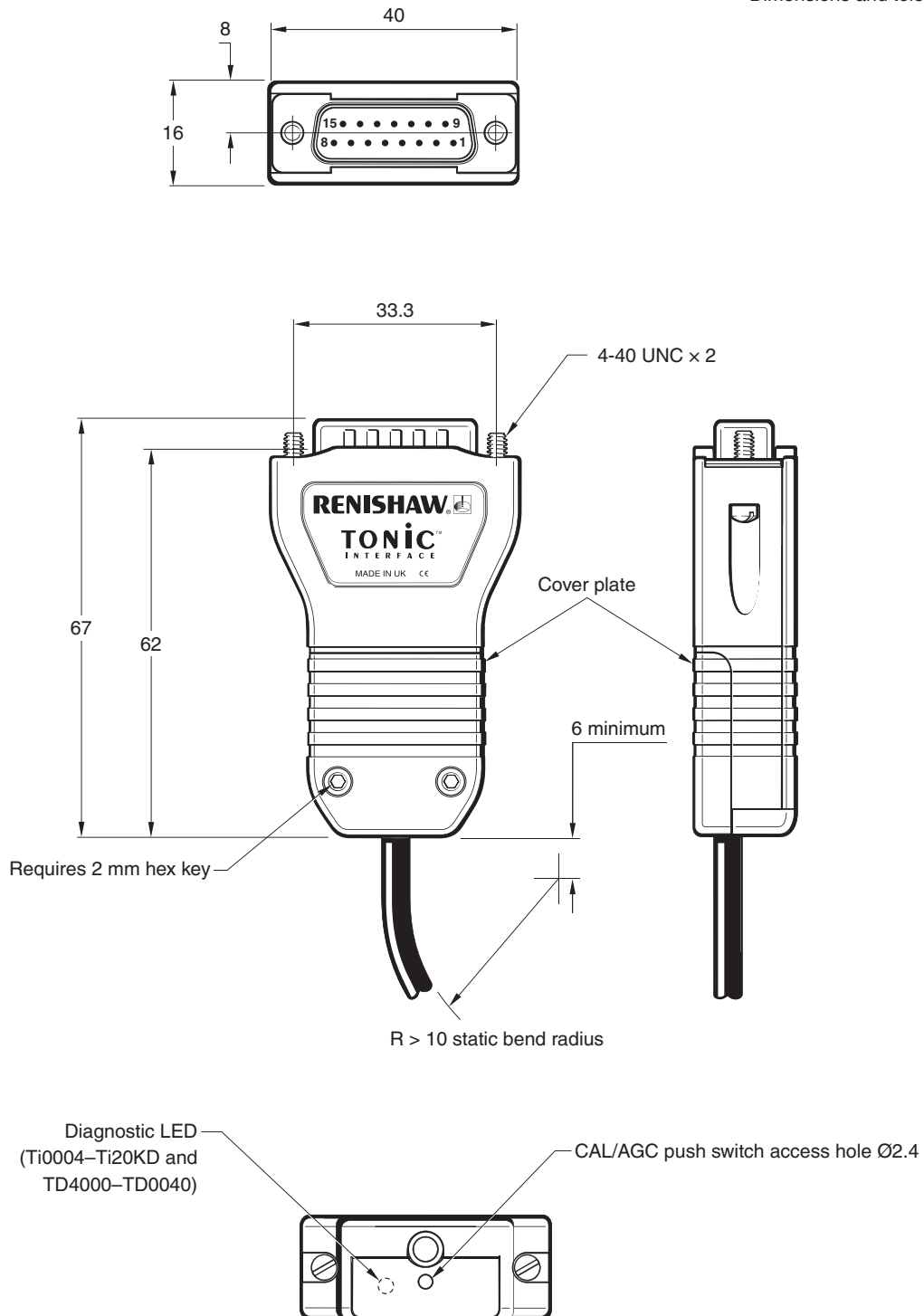

TD dual resolution interface

Allows output to be switched between two resolutions. See TD interface part number section for details of available resolutions.

NOTES:

- It is recommended that movement should be halted before switching resolutions.
- There are no limit outputs.

General specifications

| | | |
|---|-----------|--|
| Power supply ¹ | 5V ±10% | Readhead only < 100 mA T16xx/T26xx with Ti0000 < 100 mA T16xx/T26xx with Ti0004 - Ti20KD or TD4000 - TD0040 < 200 mA For digital outputs, a further 25 mA per channel pair (e.g., A+, A-) will be drawn when terminated with 120R For analogue outputs, a further 20 mA in total will be drawn when terminated with 120R Power from a 5 Vdc supply complying with the requirements for SELV of standard IEC 60950-1 |
| | Ripple | 200 mVpp maximum @ frequency up to 500 kHz |
| Temperature (system) | Storage | -20 °C to +70 °C |
| | Operating | 0 °C to +70 °C |
| | Bake-out | 120 °C |
| Humidity (system) | | 95% relative humidity (non-condensing) to IEC 60068-2-78 |
| Sealing | Readhead | IP20 |
| | Interface | IP20 |
| Acceleration (readhead) | Operating | 500 m/s ² , 3 axes |
| Shock (system) | Operating | 500 m/s ² , 11 ms, ½ sine, 3 axes |
| Vibration (system) | Operating | Sinusoidal 100 m/s ² max @ 55 Hz to 2000 Hz, 3 axes |
| Mass | Readhead | 10 g |
| | Interface | 100 g |
| | Cable | 14 g/m |
| EMC compliance (system) | | IEC 61326-1 |
| Readhead cable | | Tinned copper braided single screen. FEP core insulation |
| Typical sub-divisional error (SDE) | | ±30 nm |

¹ Current consumption figures refer to unterminated systems.

Speed

| Clocked output option (MHz) | Maximum speed (m/s) | | | | | | | | | | |
|-----------------------------|---------------------|----------------|------------------|------------------|------------------|-----------------|-----------------|-----------------|----------------|----------------|----------------|
| | Ti0004 5 µm | Ti0020 1 µm | Ti0040 0.5 µm | Ti0100 0.2 µm | Ti0200 0.1 µm | Ti0400 50 nm | Ti1000 20 nm | Ti2000 10 nm | Ti4000 5 nm | Ti10KD 2 nm | Ti20KD 1 nm |
| 50 | 10 | 10 | 10 | 6.48 | 3.240 | 1.625 | 0.648 | 0.324 | 0.162 | 0.065 | 0.032 |
| 40 | 10 | 10 | 10 | 5.40 | 2.700 | 1.350 | 0.540 | 0.270 | 0.135 | 0.054 | 0.027 |
| 25 | 10 | 10 | 8.10 | 3.24 | 1.620 | 0.810 | 0.324 | 0.162 | 0.081 | 0.032 | 0.016 |
| 20 | 10 | 10 | 6.75 | 2.70 | 1.350 | 0.670 | 0.270 | 0.135 | 0.068 | 0.027 | 0.013 |
| 12 | 10 | 9 | 4.50 | 1.80 | 0.900 | 0.450 | 0.180 | 0.090 | 0.045 | 0.018 | 0.009 |
| 10 | 10 | 8.10 | 4.05 | 1.62 | 0.810 | 0.400 | 0.162 | 0.081 | 0.041 | 0.016 | 0.0081 |
| 08 | 10 | 6.48 | 3.24 | 1.29 | 0.648 | 0.324 | 0.130 | 0.065 | 0.032 | 0.013 | 0.0065 |
| 06 | 10 | 4.50 | 2.25 | 0.90 | 0.450 | 0.225 | 0.090 | 0.045 | 0.023 | 0.009 | 0.0045 |
| 04 | 10 | 3.37 | 1.68 | 0.67 | 0.338 | 0.169 | 0.068 | 0.034 | 0.017 | 0.0068 | 0.0034 |
| 01 | 4.2 | 0.84 | 0.42 | 0.16 | 0.084 | 0.042 | 0.017 | 0.008 | 0.004 | 0.0017 | 0.0008 |
| Analogue output | 10 (-3 dB) | | | | | | | | | | |

NOTE: TD interface maximum speeds are resolution dependent, as defined above.

Angular speed depends on ring diameter – use the following equation to convert to rev/min:

$$\text{Angular speed (rev/min)} = \frac{V \times 1000 \times 60}{\pi D} \quad \text{Where } V = \text{maximum linear speed (m/s) and} \\ D = \text{external diameter of RESM20 or REXM20 ring (mm).}$$

Output signals

Digital outputs

| Function | Signal | Interface | | |
|-----------------------------------|----------------|--------------------|-------------------|----|
| | | Ti0004 – Ti20KD | TD4000 –TD0040 | |
| Power | 5 V | 7, 8 | 7, 8 | |
| | 0 V | 2, 9 | 2, 9 | |
| Incremental | A | + | 14 | 14 |
| | | – | 6 | 6 |
| | B | + | 13 | 13 |
| | | – | 5 | 5 |
| Reference mark | Z | + | 12 | 12 |
| | | – | 4 | 4 |
| Limits | P ¹ | 11 | - | |
| | Q | 10 | - | |
| Set-up | X | 1 | 1 | |
| Alarm ² | E | + | - | 11 |
| | | – | 3 | 3 |
| Resolution switching ³ | - | - | 10 | |
| Shield | Inner | - | - | |
| | Outer | Case | Case | |

Analogue outputs

| Function | Signal | Readhead T16xx/26xx | | Interface Ti0000 | |
|----------------|----------------|------------------------|--------|---------------------|-----|
| | | Colour | Pin | Colour | Pin |
| Power | 5 V | Brown | 4, 5 | | |
| | 0 V | White | 12, 13 | | |
| Incremental | Cosine | V ₁ | + | Red | 9 |
| | | | – | Blue | 1 |
| | Sine | V ₂ | + | Yellow | 10 |
| | | | – | Green | 2 |
| Reference mark | V ₀ | + | Violet | 3 | |
| | | – | Grey | 11 | |
| Limits | V _p | Pink | 7 | | |
| | V _q | Black | 8 | | |
| Set-up | V _x | Clear | 6 | | |
| Remote CAL | CAL | Orange | 14 | | |
| Shield | - | Screen | Case | | |

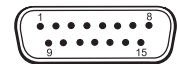

15-pin D-type connector

¹ Becomes alarm (E+) for Ti options E, F, G, H.

² The alarm signal can be output as a line-driven signal or 3-state. Please select the preferred option at time of ordering.

³ On TD interfaces pin 10 should be connected to 0 V to switch to lower resolution.

RGA results

Test schedule

A quadrupole mass spectrometer (AccuQuad 200 RGA), set to 200AMU scan range, was used to collect RGA (residual gas analysis) data and to measure total chamber pressure. After initial conditioning of the system, a background spectrum was recorded together with the total pressure in the test chamber.

The component was placed in the vacuum chamber (0.015 m³) and the system was then pumped using an KJL Lion 802 (800/s) diode ion pump and a Divac diaphragm pump at ambient temperature for 24 hours, after which a background scan and the total pressure in the test chamber were recorded again. If the system pressure was better than 5×10^{-9} mbar, the test specimen was baked at 120 °C for 48 hours. The system was then allowed to cool to ambient temperature before a final mass spectrum and the total pressure in the test chamber were recorded. These final RGA scans are shown below.

NOTE: Exact reproduction of these results should not be expected, as RGA data depends on many factors including environmental factors and initial chamber conditions. However, the data is fully representative of vacuum performance.

TONiC readhead with 1.0 m cable after bake-out (total pressure = 9.0×10^{-10} mbar)

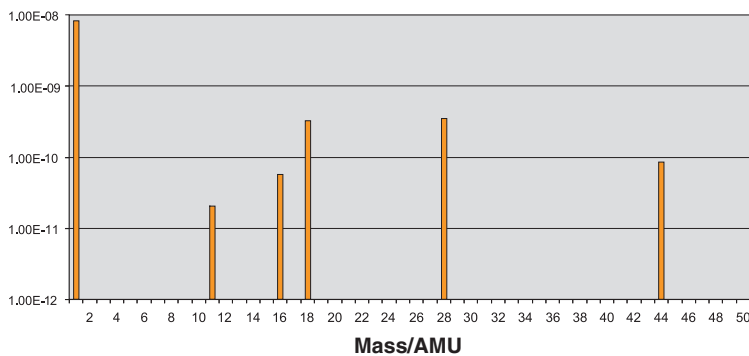

RSLM20 linear scale (180 mm length) with two clips and one clamp after bake-out (total pressure = 3.0×10^{-10} mbar)

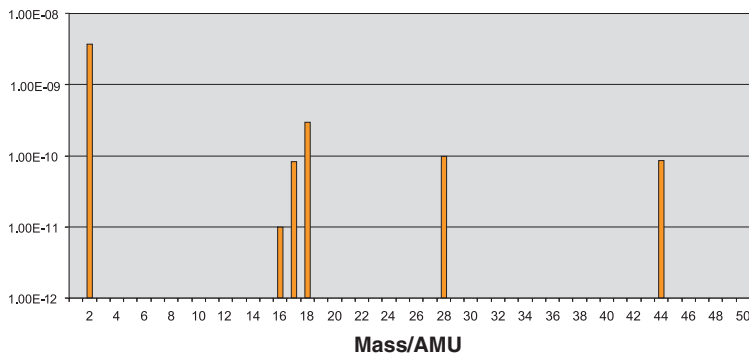

RESM20 (Ø115 mm) after bake-out (total pressure = 7.76×10^{-10} mbar)

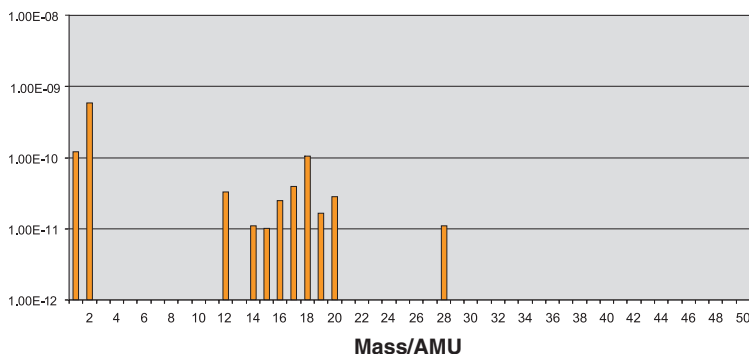

Electrical connections

Grounding and shielding

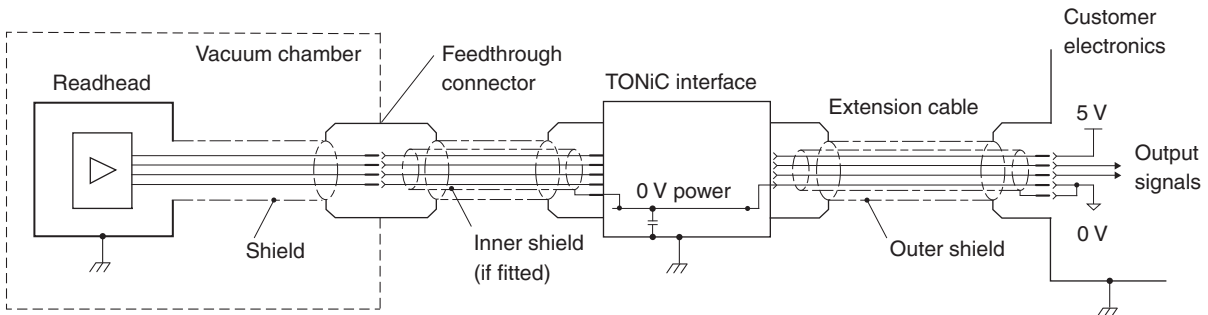

IMPORTANT: The outer shield should be connected to the machine earth (Field Ground). The inner shield should be connected to 0 V at receiving electronics only. Care should be taken to ensure that the inner and outer shields are insulated from each other. If the inner and outer shields are connected together, this will cause a short between 0 V and earth, which could cause electrical noise issues.

Maximum cable length

Readhead to interface: 10 m
Interface to controller: Dependent on clocked output option.
See table below for details.

| Receiver clock frequency (MHz) | Maximum cable length (m) |
|--------------------------------|--------------------------|
| 40 to 50 | 25 |
| < 40 | 50 |
| analogue | 50 |

Remote CAL operation (analogue versions only)

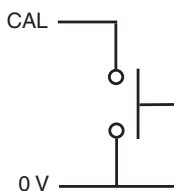

All Ti and TD interfaces include a push-button switch to enable CAL/AGC features. Remote operation of the CAL/AGC is possible via pin 14 of analogue Ti0000 interfaces. For applications where no interface is used, remote operation of CAL/AGC is essential.

Recommended signal termination

Digital outputs

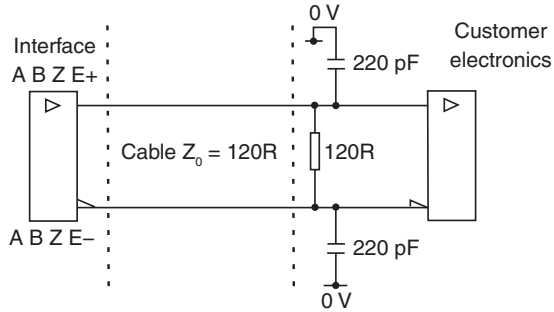

Standard RS422A line receiver circuitry.

Capacitors recommended for improved noise immunity.

Single-ended alarm signal termination (Ti options A, B, C, D)

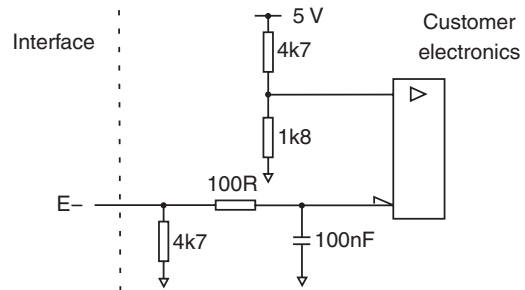

Limit outputs (Ti interface only)

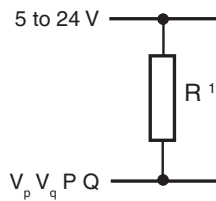

Analogue outputs

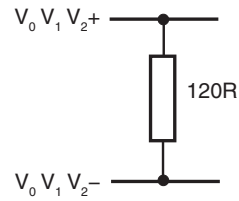

¹ Select R so maximum current does not exceed 20 mA. Alternatively, use a suitable relay or opto-isolator.

Output specifications

Digital output signals

Interface models Ti0004 – Ti20KD and TD4000 – TD0040

Form – Square wave differential line driver to EIA RS422A (except limits P and Q).

Incremental ¹

Two channels A and B in quadrature (90° phase shifted)

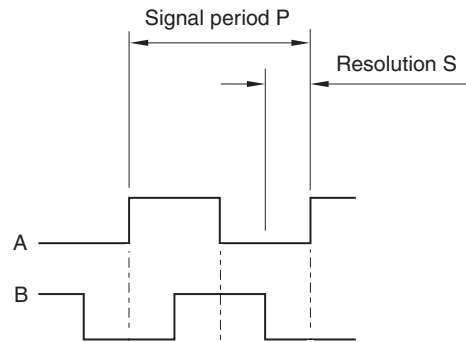

| Model | P (μm) | S (μm) |
|--------|--------|--------|
| Ti0004 | 20 | 5 |
| Ti0020 | 4 | 1 |
| Ti0040 | 2 | 0.5 |
| Ti0100 | 0.8 | 0.2 |
| Ti0200 | 0.4 | 0.1 |
| Ti0400 | 0.2 | 0.05 |
| Ti1000 | 0.08 | 0.02 |
| Ti2000 | 0.04 | 0.01 |
| Ti4000 | 0.02 | 0.005 |
| Ti10KD | 0.008 | 0.002 |
| Ti20KD | 0.004 | 0.001 |

Reference ¹

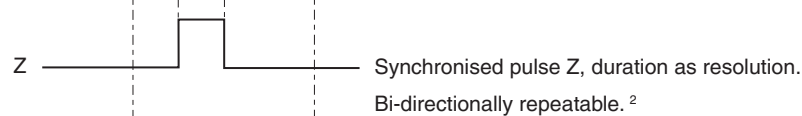

Wide reference ¹

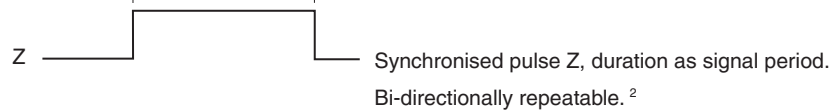

NOTES:

- Select “standard” or “wide” reference at time of ordering, to match the requirements of the controller being used.
- Wide reference mark not available on Ti0004.

¹ For clarity, the inverse signals are not shown.

² Only the calibrated reference mark is bi-directionally repeatable.

Limits

Open collector output, asynchronous pulse.

Digital Ti interfaces only

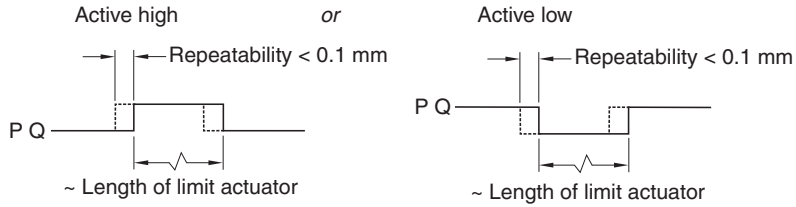

NOTES:

- There are no limits on TD interfaces.
- P limit becomes E+ for Ti options E, F, G and H.

Alarm ¹

Line driven (asynchronous pulse)

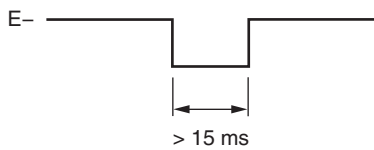

Alarm asserted when:

- Signal amplitude < 20% or > 135%
- Readhead speed too high for reliable operation

Inverse signal E+ only available for Ti options E, F, G and H.

or 3-state alarm

Differentially transmitted signals are forced open circuit for > 15 ms when the alarm conditions are valid.

Set-up ²

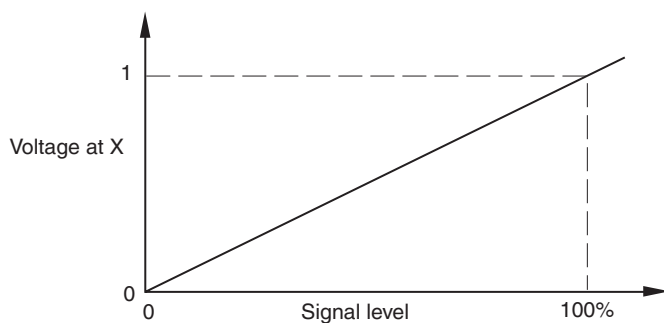

The set-up signal voltage is proportional to incremental signal amplitude.

¹ For clarity, the inverse signals are not shown.

² The set-up signal as shown is not present during the calibration routine.

Analogue output signals

Interface model Ti0000 and direct output from all readheads

Incremental

Two channels V_1 and V_2 differential sinusoids in quadrature, centred on 1.65 V (90° phase shifted).

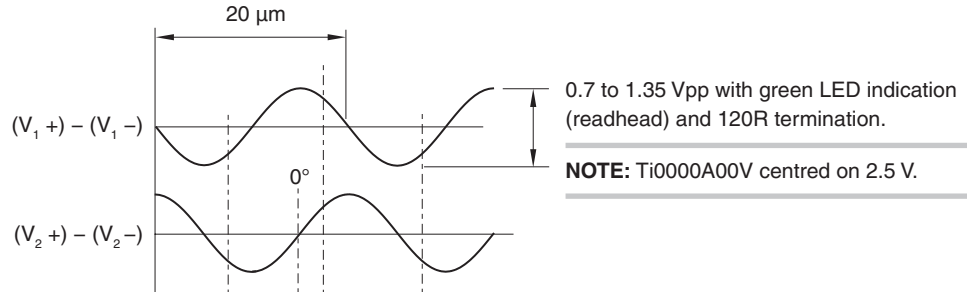

Reference

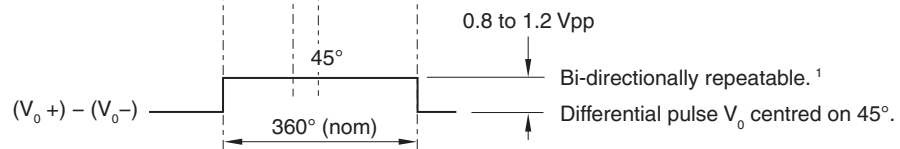

Limits

Open collector output, asynchronous pulse.

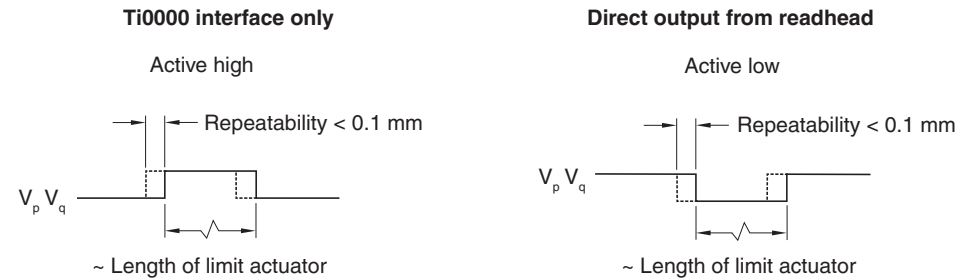

NOTE: Ti0000 interface contains a transistor to invert the readhead's "active low" signal to give an "active high" output.

Set-up ²

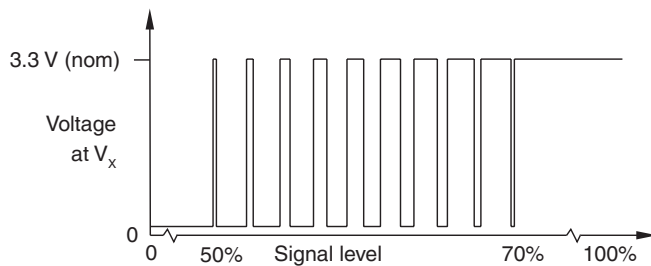

Between 50% and 70% signal level, V_x is a duty cycle.
Time spent at 3.3 V increases with incremental signal level.
At > 70% signal level V_x is nominal 3.3 V.

¹ Only the calibrated reference mark is bi-directionally repeatable.

² The set-up signal as shown is not present during calibration routine.

Linear readhead part numbers

T 1 6 1 0-15 M

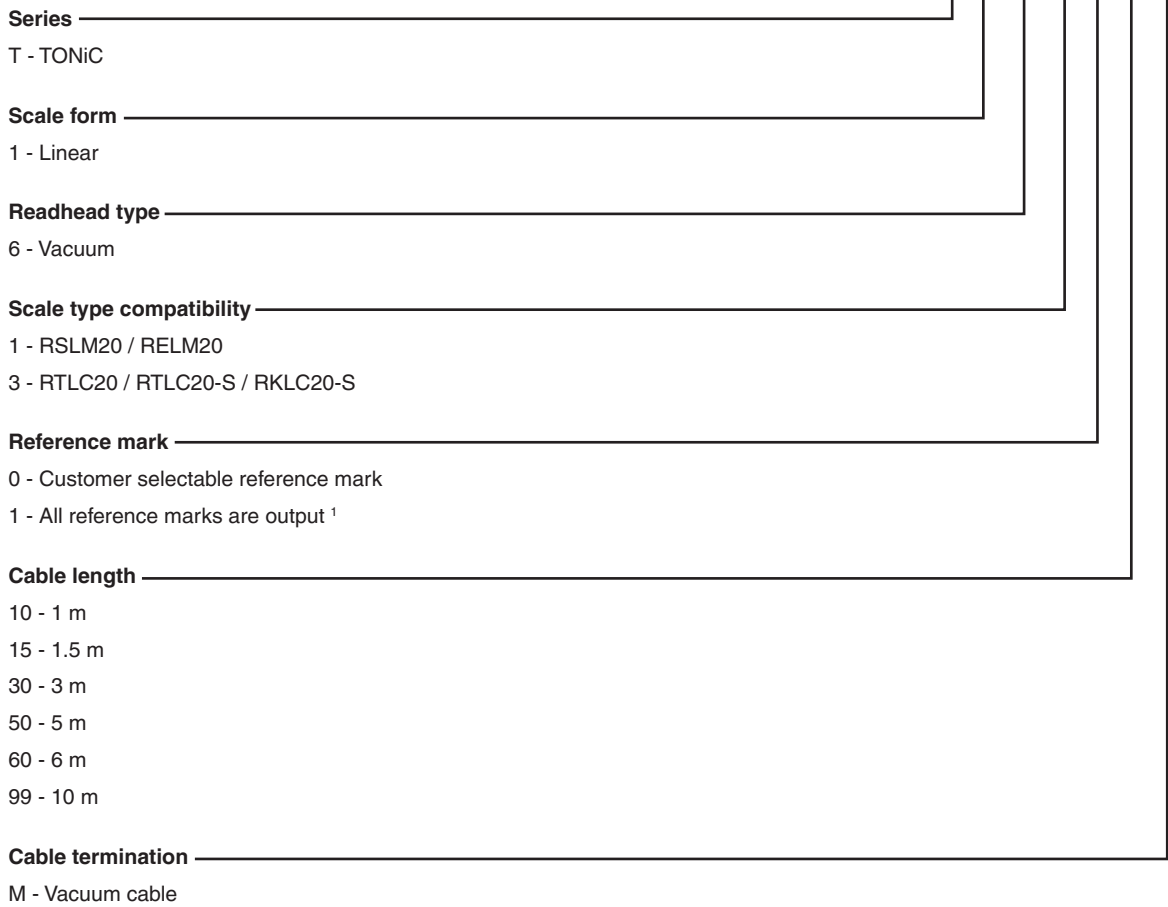

NOTE: Not all combinations are valid. Check valid options online at www.renishaw.com/epc.

¹ Only the calibrated reference mark is bi-directionally repeatable.

Rotary readhead part numbers

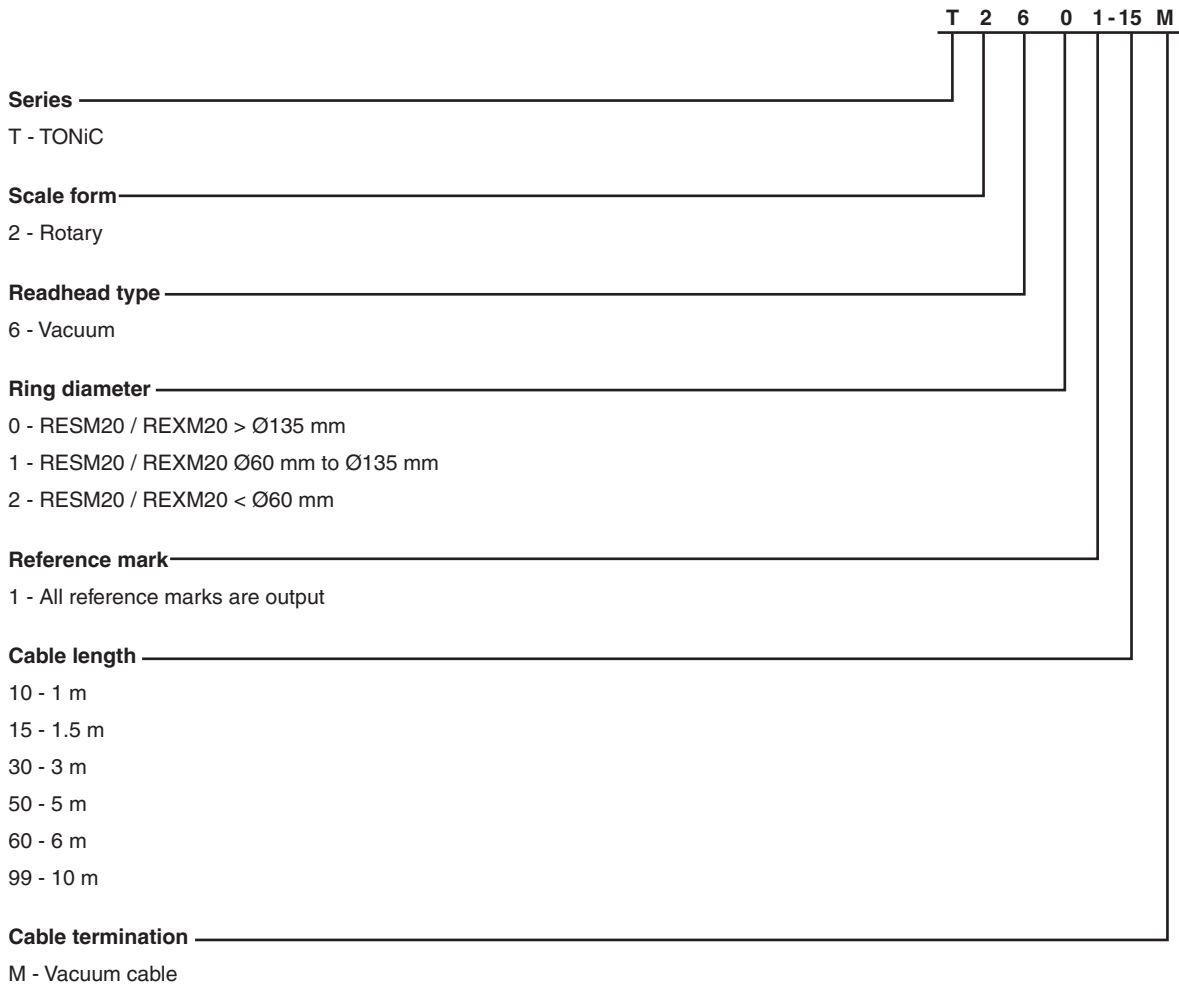

NOTES:

- Not all combinations are valid. Check valid options online at www.renishaw.com/epc.
 - Contact your local Renishaw representative if you require a partial arc application.
-

Ti interface part numbers

Compatible with all TONiC readheads

Analogue

Ti 0000 A 00 A

Options

A - Dual active high limits

V - 2V5 Vmid dual active high limits

Digital

Ti 0200 A 20 A

Series

Ti - TONiC interface

Interpolation factor/resolution ¹

| | |
|--------------------------|--------------|
| 0004 - 5 μm ² | 1000 - 20 nm |
| 0020 - 1 μm | 2000 - 10 nm |
| 0040 - 0.5 μm | 4000 - 5 nm |
| 0100 - 0.2 μm | 10KD - 2 nm |
| 0200 - 0.1 μm | 20KD - 1 nm |
| 0400 - 50 nm | |

Alarm format and conditions ³

A - Line driven E output; All alarms

B - Line driven E output; Low signal and high signal alarms only

E - 3-state; All alarms

F - 3-state; Low signal and high signal alarms only

Clocked output option ³

| | |
|-------------|-------------|
| 50 - 50 MHz | 10 - 10 MHz |
| 40 - 40 MHz | 08 - 8 MHz |
| 25 - 25 MHz | 06 - 6 MHz |
| 20 - 20 MHz | 04 - 4 MHz |
| 12 - 12 MHz | 01 - 1 MHz |

Options

A - P/Q limits – “active high”, standard reference mark

B - P/Q limits – “active low”, standard reference mark

C - P/Q limits – “active high”, wide reference mark ²

D - P/Q limits – “active low”, wide reference mark ²

E - Q limit only – “active high”, differential alarm, standard reference mark

F - Q limit only – “active low”, differential alarm, standard reference mark

G - Q limit only – “active high”, differential alarm, wide reference mark ²

H - Q limit only – “active low”, differential alarm, wide reference mark ²

NOTES:

- Only the readhead is UHV compatible; the Ti interface must be kept outside the vacuum chamber.
- Not all combinations are valid. Check valid options online at www.renishaw.com/epc.

¹ Additional interpolation factors available. Contact your local Renishaw representative for further details.

² Wide reference mark not available on Ti0004 (5 μm) interfaces.

³ When using with a DSi, the interface should be configured with line-driven alarm outputs and a clocked output option of 01, 04, 06, 08, 10, 12 or 20.

TD interface part numbers

Compatible with all TONiC readheads

Dual resolution

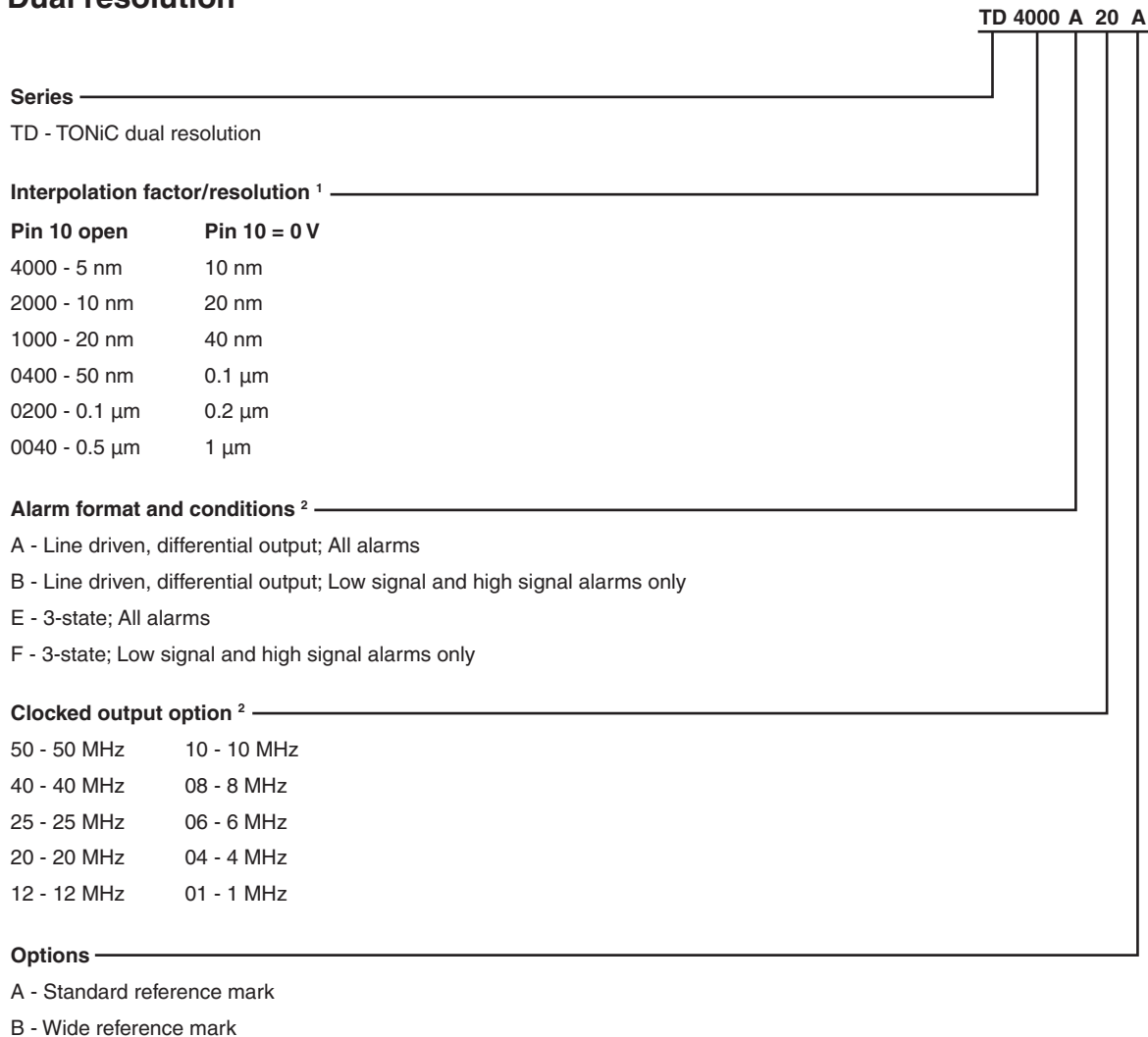

NOTES:

- Only the readhead is UHV compatible; the TD interface must be kept outside the vacuum chamber.
- Not all combinations are valid. Check valid options online at www.renishaw.com/epc.

¹ Additional interpolation factors are available. Contact your local Renishaw representative for further details.

² When using with a DSi, the interface should be configured with line-driven alarm outputs and a clocked output option of 01, 04, 06, 08, 10, 12 or 20.

TONiC UHV compatible products

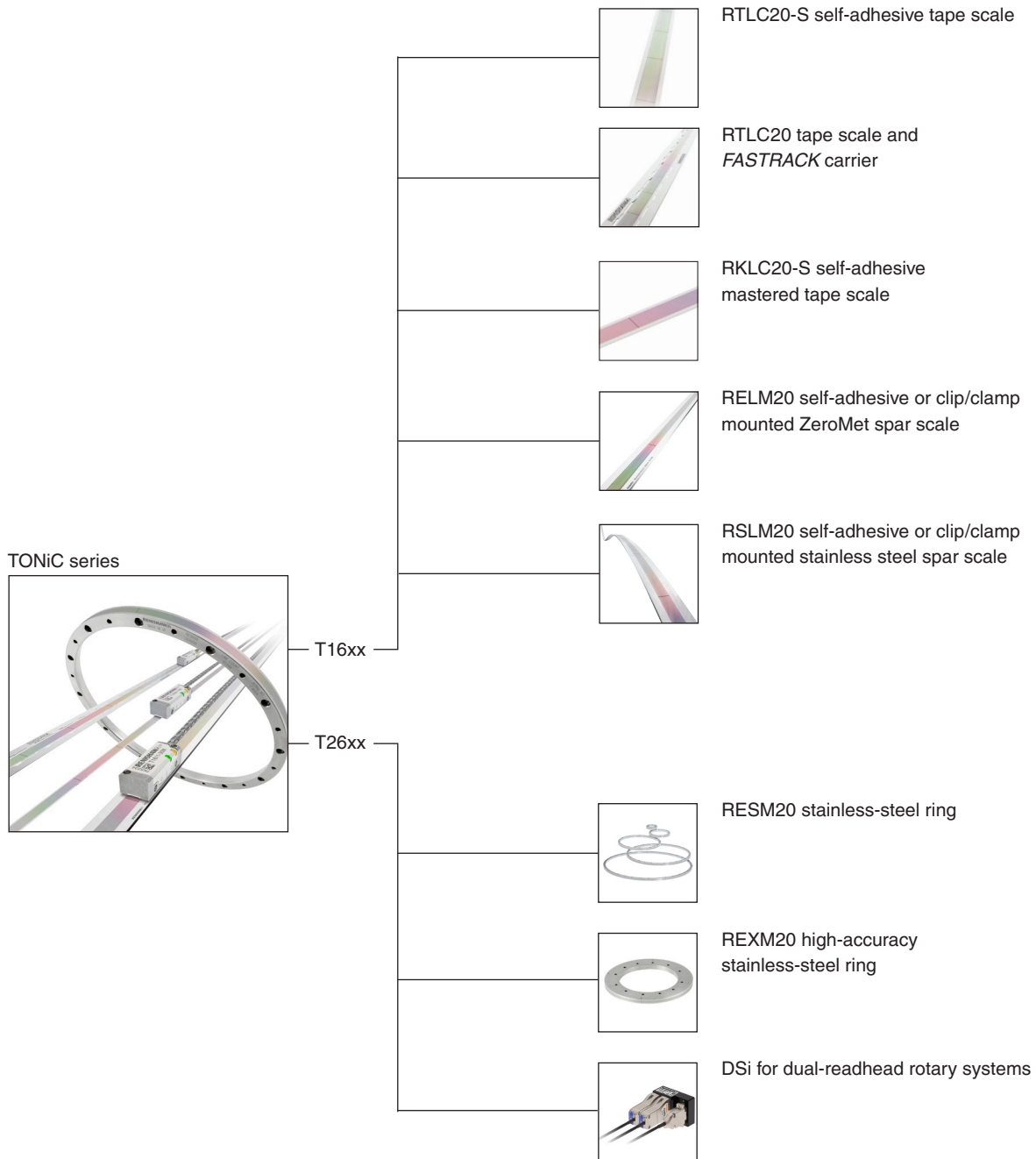

www.renishaw.com/contact

#renishaw

+44 (0) 1453 524524

uk@renishaw.com

© 2009–2024 Renishaw plc. All rights reserved. This document may not be copied or reproduced in whole or in part, or transferred to any other media or language by any means, without the prior written permission of Renishaw.

RENISHAW® and the probe symbol are registered trade marks of Renishaw plc. Renishaw product names, designations and the mark "apply innovation" are trade marks of Renishaw plc or its subsidiaries. Other brand, product or company names are trade marks of their respective owners.

WHILE CONSIDERABLE EFFORT WAS MADE TO VERIFY THE ACCURACY OF THIS DOCUMENT AT PUBLICATION, ALL WARRANTIES, CONDITIONS, REPRESENTATIONS AND LIABILITY, HOWSOEVER ARISING, ARE EXCLUDED TO THE EXTENT PERMITTED BY LAW. RENISHAW RESERVES THE RIGHT TO MAKE CHANGES TO THIS DOCUMENT AND TO THE EQUIPMENT, AND/OR SOFTWARE AND THE SPECIFICATION DESCRIBED HEREIN WITHOUT OBLIGATION TO PROVIDE NOTICE OF SUCH CHANGES.

Renishaw plc. Registered in England and Wales. Company no: 1106260. Registered office: New Mills, Wotton-under-Edge, Glos, GL12 8JR, UK.

Part no.: L-9517-9426-04-A

Issued: 07.2024