

# RGH41 encoder system

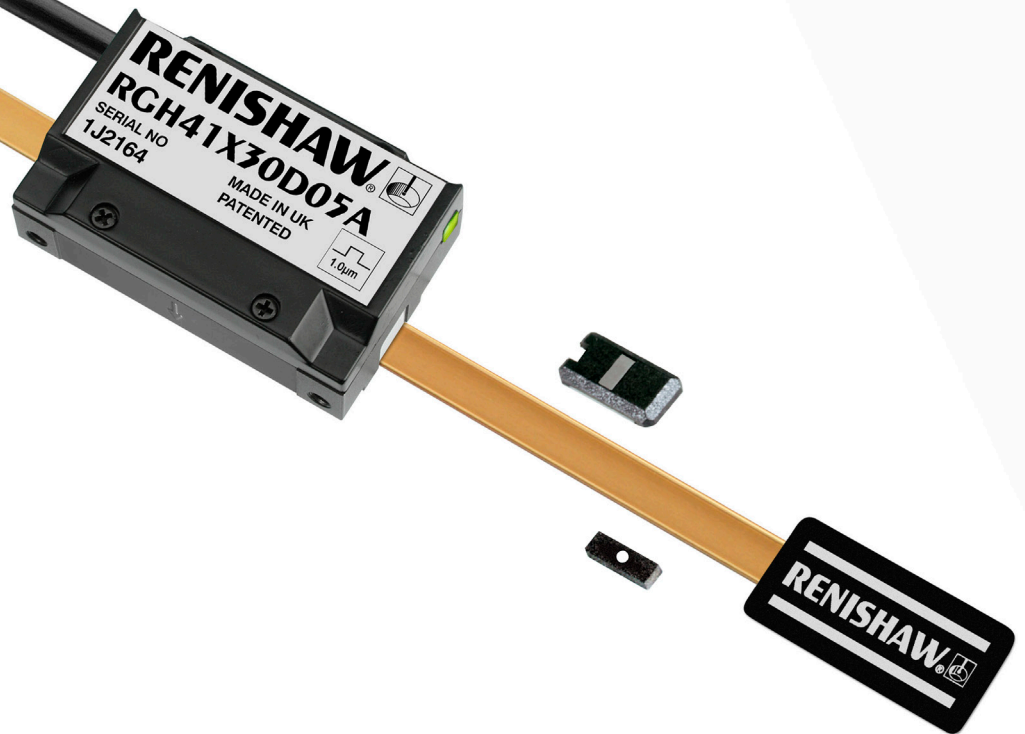

**The Renishaw RGH41 series is a non-contact optical encoder system, providing highly-reliable positional feedback.**

The readhead offers the benefits of Renishaw's established encoder series, such as a set-up LED indicator for easy installation, and unique filtering optics for excellent dirt immunity. In addition to these popular features, the RGH41 adds higher speeds for improved productivity, and improved setup tolerances.

The RGH41 reads the 40 µm pitch RGS40-S gold tape-scale and outputs a choice of industry standard 1 Vpp analogue or RS422 digital signals with a wide range of resolutions. RGS40-S is suitable for mounting to most common engineering materials including metals, granites, ceramics and composites. The scale can be mastered to the axis substrate by means of specially formulated pre-applied adhesive and epoxy fastened 'end clamps'. This method ensures the differential movement between the scale and the substrate is close to zero, even with significant temperature swings.

The flexibility of the RGH41 system enables its application in a wide spectrum of industries, from co-ordinate measuring and layout machines to electronics assembly and test, linear motors and a host of custom linear motor solutions.

## RGH41 readhead

- Non-contact open optical system
- Integral interpolation
- Industry standard digital and analogue options
- Resolutions from 10 µm to 50 nm
- Integral reference and limit sensors
- Integral set-up LED

## RGS40-S scale

- 'Cut-to-length' convenience
- Lengths from 100 mm to over 50 m
- Efficient, accurate installation
- Affixes to most common engineering materials
- Self-adhesive backing tape
- Applicator tool allows scale to be installed using the motion of the axis



## General specifications

<b>Power supply</b>	5 V ±5%	RGH41A < 140 mA RGH41B < 120 mA RGH41T, D, G, X < 95 mA RGH41N, W, Y, H < 150 mA	
	Ripple	<b>NOTE:</b> Current consumption figures refer to unterminated readheads. For digital outputs a further 35 mA per channel pair (e.g. A+, A-) will be drawn when terminated with 120 Ω. For analogue outputs a further 20 mA will be drawn when terminated with 120 Ω. Power from a 5 V dc supply complying with the requirements for SELV of standard IEC BS EN 60950-1. 200 mVpp@frequency up to 500 kHz maximum.	
<b>Temperature</b>	Storage	-20 °C to +70 °C	
	Operating	0 °C to +55 °C	
<b>Humidity</b>		95% relative humidity (non-condensing) to EN 60068-2-78	
<b>Sealing</b>		IP50	
<b>Acceleration</b>	Operating	500 m/s <sup>2</sup> , 3 axes	
<b>Shock</b>	Non-operating	1000 m/s <sup>2</sup> , 6 ms, ½ sine, 3 axes	
<b>Vibration</b>	Operating	100 m/s <sup>2</sup> max @ 55 Hz to 2000 Hz, 3 axes	
<b>Mass</b>	Readhead	50 g	
	Cable	38 g/m	
<b>Cable</b>		12 core, double shielded, outside diameter 4.5 ±0.2 mm. Flex life > 20 × 10 <sup>6</sup> cycles at 50 mm bend radius.	
<b>Connector options</b>	<b>Code</b>	<b>Connector type</b>	<b>Application</b>
	D	15-way D-type plug	RGH41T, D, G, X, N, W, Y, and H
	L	15-way D-type plug	RGH41A and B
	V	12-way circular plug	RGH41A and B
	W	12-way circular coupling	RGH41A and B
	F	unterminated cable	All readheads
	X	16-way in-line connector	All readheads



## Scale specifications

<b>Scale type</b>	Reflective gold plated steel tape with protective lacquer coating. Adhesive backing tape allows direct mounting to the machine substrate.	
<b>Scale period</b>	40 $\mu\text{m}$	
<b>Linearity</b>	$\pm 3 \mu\text{m}/\text{m}$	
<b>Scale length</b>	Up to 50 m (> 50 m by special order)	
<b>Form (H x W)</b>	0.2 mm x 6 mm (includes adhesive)	
<b>Substrate materials</b>	Metals, ceramics and composites with expansion coefficients between 0 and 22 $\mu\text{m}/\text{m}/^\circ\text{C}$ (steel, aluminium, Invar, granite, ceramic etc.)	
<b>Coefficient of thermal expansion</b>	Matches that of substrate material when scale ends are fixed by epoxy mounted end clamps	
<b>End fixing</b>	Epoxy mounted end clamps (A-9523-4015) using 2 part epoxy adhesive (A-9531-0342). Scale end movement typically < 1 $\mu\text{m}$ up to +40 $^\circ\text{C}$ .	
<b>Temperature</b>	Operating	-10 $^\circ\text{C}$ to +120 $^\circ\text{C}$
	Minimum installation	10 $^\circ\text{C}$
	Storage	-20 $^\circ\text{C}$ to +70 $^\circ\text{C}$
<b>Humidity</b>	95% relative humidity (non-condensing) to EN 60068-2-78	

## Speed performance

### Digital readheads

#### Non-clocked output readheads

Head type	Maximum speed (m/s)	Lowest recommended counter input frequency (MHz)
T (10 µm)	15	$\left( \frac{\text{Encoder velocity (m/s)}}{\text{Resolution (µm)}} \right) \times 4 \text{ safety factor}$
D (5 µm)	12	
G (2 µm)	10	
X (1 µm)	6	

#### Clocked output readheads

The RGH41N, W, Y, H readheads are available with a variety of different clocked outputs. Customers must ensure they comply with the lowest recommended counter input frequency.

Options	Maximum speed (m/s)				Lowest recommended counter input frequency (MHz)
	Head type				
	N (0.4 µm)	W (0.2 µm)	Y (0.1 µm)	H (50 nm)	
61	3	2.5	1.3	0.6	20
62	2.6	1.3	0.7	0.3	10
63	1.3	0.7	0.35	0.15	5

### Analogue readheads

RGH41A and B - 8 m/s (-3dB)

## Output signals

### Connections

Digital RS422A outputs - RGH41T, D, G, X, N, W, Y and H

Function	Signal	Colour	15-way D-type plug (D)	16-way in-line connector (X)
Power	5 V	Brown	7	A
		Brown (link)	8	M
	0 V	White	2	B
		White (link)	9	N
Incremental signals	A	+	14	G
		-	6	D
	B	+	13	R
		-	5	F
Reference mark	Z	+	12	K
		-	4	O
Limit switch	Q	Pink	10	H
Alarm / limit*	E+/P	Black	11	I
Alarm	E-	Orange	3	P
External set-up	X	Clear	1	E
Shield	Inner	Green / Yellow	15	L
	Outer	-	Case	Case

\*Options 05/06 (dual limit) utilise the black wire for limit switch function 'P'.

Options 03/04 (single limit) utilise the black wire for alarm function 'E+'. Please select the preferred option at time of ordering.

15-way D-type plug (termination code D)

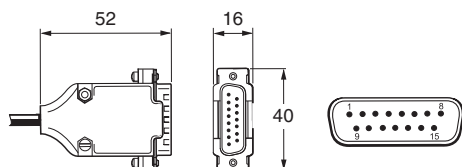

In-line connector plug (termination code X)

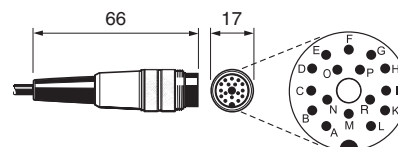

## Connections

### Analogue 1 Vpp outputs - RGH41A and B

Function	Signal	Colour	15-way D-type plug (L)	12-way circular (V)	12-way circular coupling (W)	16-way in-line connector (X)
Power	5 V	Brown	4	2	2	A
		Brown (link)	5	12	12	M
	0 V	White	12	10	10	B
		White (link)	13	11	11	N
Incremental signals	V <sub>1</sub>	+	9	5	5	F
		-	1	6	6	R
	V <sub>2</sub>	+	10	8	8	D
		-	2	1	1	G
Reference mark	V <sub>0</sub>	+	3	3	3	K
		-	11	4	4	O
Limit switch	V <sub>q</sub>	Pink	8	N/C	N/C	H
Dual limit / external set-up*	V <sub>p</sub> / V <sub>x</sub>	Clear	7	N/C	N/C	E
BID DIR connections‡	BID	Black	6	9†	9††	I
	DIR	Orange	14	7†	7††	P
Shield	Inner	Green / Yellow	15	11 (link)	11 (link)	L
	Outer	-	Case	Case	Case	Case

\*Dual limit versions (RGH41A) utilise the clear wire for limit switch function 'V<sub>q</sub>'.

Single limit versions (RGH41B) utilise the clear wire for external set-up function 'V<sub>x</sub>'. Please select the preferred readhead version at time of ordering.

† Only connected with option 17 †† Only connected with option 18

### ‡Reference mark uni-directional operation

The RGH41 reference mark output is repeatable for one direction of travel only. Certain controllers will flag an error when they detect different reference mark positions in the forward and reverse directions.

BID / DIR pins allow the readhead to be configured to ignore the reference pulse output in one unphased direction (see installation guide for more information on reference mark set-up).

### BID / DIR connections

BID / DIR connection For bi-directional operation (normal)	To:-	Reference mark output direction
<b>BID</b>	+5 V or not connected	Forward <b>and</b> reverse
<b>DIR</b>	Do not connect	

BID / DIR connection For uni-directional operation	To:-	Reference mark output direction
<b>BID</b>	0 V	Forward <b>only</b>
<b>DIR</b>	+5 V or not connected	
<b>DIR</b>	0 V	Reverse <b>only</b>

12-way circular plug (termination code V)

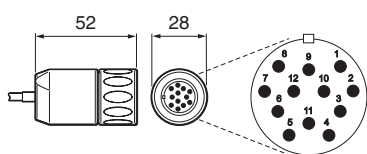

15-way D-type plug (termination code L)

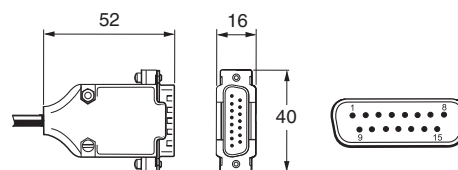

12-way circular coupling (termination code W)

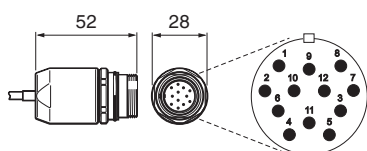

In-line connector plug (termination code X)

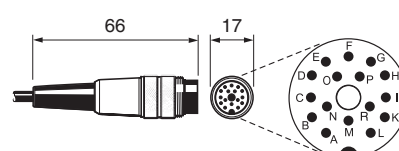

## Electrical connections

### Grounding and shielding

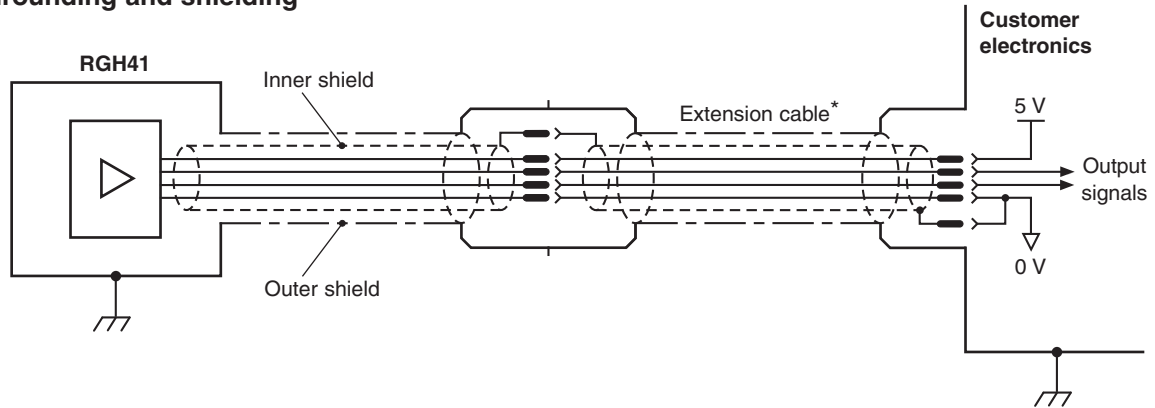

\*Maximum extension cable length: RGH41A and B - 100 m, RGH41T, D, G and X - 50 m, RGH41N, W, Y and H - 20 m

**IMPORTANT:** The outer shield should be connected to the machine earth (Field Ground). The inner shield should be connected to 0 V. Care should be taken to ensure that the inner and outer shields are insulated from each other. If the inner and outer shields are connected together, this will cause a short between 0 V and earth, which could cause electrical noise issues.

## Recommended signal terminations

### Digital outputs - RGH41T, D, G, X, N, W, Y and H

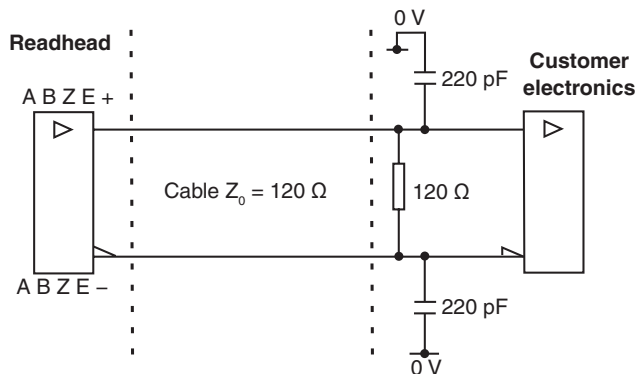

Standard RS422A line receiver circuitry.  
Capacitors recommended for improved noise immunity.

### Analogue outputs - RGH41A and B

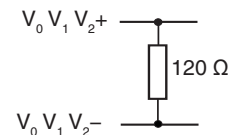

### Single ended alarm signal termination

(Option 05/06)

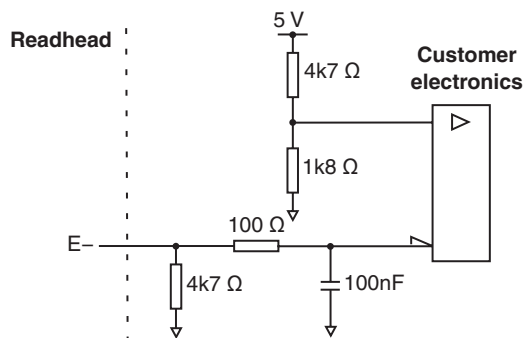

### Limit output

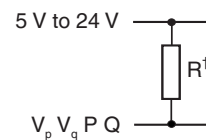

†Select R so that the maximum current does not exceed 20 mA.  
Alternatively, use a relay or opto-isolator.



## Output specifications

### Digital output signals - RGH41T, D, G, X, N, W, Y and H

Form - Square wave differential line driver to EIA RS422A (except limit switches P, Q and external set-up signal X)

**Incremental†** 2 channels A and B in quadrature (90° phase shifted)

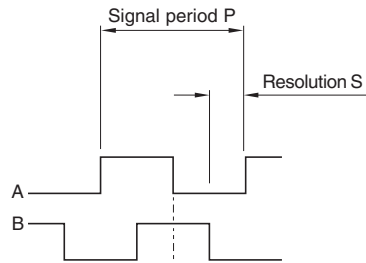

Model	P (μm)	S (μm)
RGH41T	40	10
RGH41D	20	5
RGH41G	8	2
RGH41X	4	1
RGH41N	1.6	0.4
RGH41W	0.8	0.2
RGH41Y	0.4	0.1
RGH41H	0.2	0.05

**Reference†**

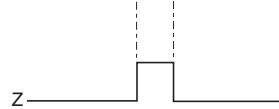

Synchronised pulse Z, duration as resolution S. Repeatability of position (uni-directional) maintained within ±20 °C from installation temperature and for speed < 0.5 m/s.

For RGH41N, W, Y and H only the Z pulse is re-synchronised at power-up with any one of the quadrature states (00, 01, 11, 10).

**Limit** open collector output, asynchronous pulse

**Single limit (option 03/04)**

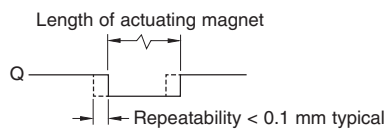

**Dual limit (option 05/06)**

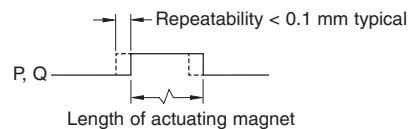

**Set-up**

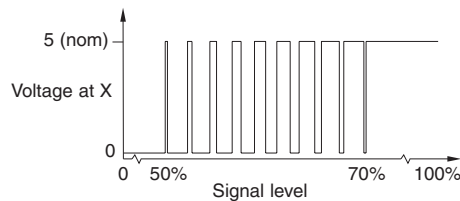

Between 50% and 70% signal level, X is a duty cycle.  
Time spent at 5 V increases with signal level.  
At > 70% signal level X is nominal 5 V.

**Alarm**

**RGH41T, D, G, and X**

Alarm output asserted when < 15% signal.

Option	Alarm type
03 (single limit)	differential line driven output
04 (single limit)	3-state output
05 (dual limit)	single ended line driven output
06 (dual limit)	3-state output

**RGH41N, W, Y and H**

**Options 61, 62 and 63 (dual limit only)**

Single ended line driven output alarm asserted when > 150% signal or overspeed.

3-state output alarm asserted when < 15% signal.

**Line driven alarm output†**

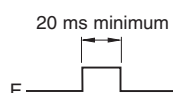

E- only on dual limit readheads

**3-state alarm output**

Differentially transmitted signals forced open circuit for > 20 ms when alarm conditions valid.

† Inverse signals not shown for clarity

## Output specifications (continued)

### Analogue 1 Vpp output signals – RGH41A and B

**Incremental** 2 channels  $V_1$  and  $V_2$  differential sinusoids in quadrature (90° phase shifted)

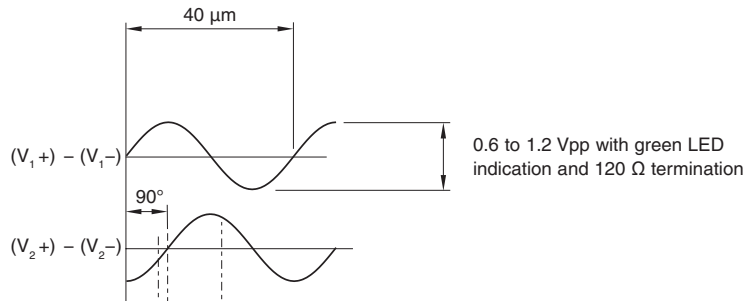

### Reference

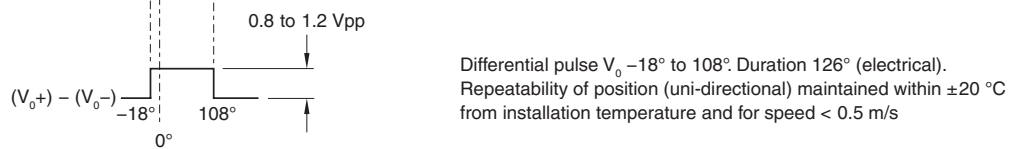

**Limit** open collector output, asynchronous pulse

#### Single limit RGH41B

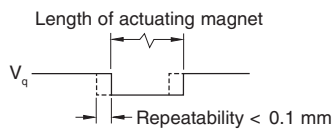

#### Dual limit RGH41A

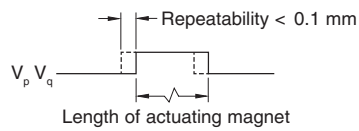

### Set-up

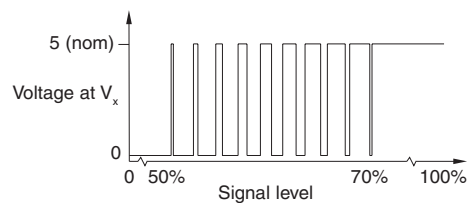

Between 50% and 70% signal level,  $V_x$  is a duty cycle.  
Time spent at 5 V increases with signal level.  
At > 70% signal level  $V_x$  is nominal 5 V.



RGH41 system = readhead



+ scale

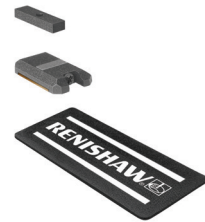

+ accessories

## Readhead part numbers

**RGH41 B 15 L 00A**

### Readhead series

#### Output

##### Analogue

A = 1 V<sub>pp</sub> (dual limits)

B = 1 V<sub>pp</sub> (single limit)

##### Digital

T = 10 μm

D = 5 μm

G = 2 μm

X = 1 μm

N = 0.4 μm

W = 0.2 μm

Y = 0.1 μm

H = 50 nm

#### Cable length

05 = 0.5 m

10 = 1 m

15 = 1.5 m

30 = 3 m

50 = 5 m

#### Termination

D = 15-way D-type plug (RGH41T, D, G, X, N, W, Y and H only)

F = Flying lead (unterminated)

L = 15-way D-type plug (RGH41A and B only)

S = To be used in conjunction with option 17A and 18A (RGH41B only - limits not available)

V = 12-way circular plug for analogue (RGH41B only - limits not available)

W = 12-way circular coupling (RGH41B only - limits not available)

X = 16-way in-line connector

#### Options

00A = Analogue 1 V<sub>pp</sub> (RGH41A and B only)

03A = Digital head, single limit, differential alarm signal (RGH41T, D, G and X only)

04A = Digital head, single limit, 3-state alarm signal (RGH41T, D, G and X only)

05A = Digital head, dual limit, single ended alarm signal (RGH41T, D, G and X only)

06A = Digital head, dual limit, 3-state alarm signal (RGH41T, D, G and X only)

17A = Analogue 1 V<sub>pp</sub>, V termination with BID/DIR (RGH41B only)

18A = Analogue 1 V<sub>pp</sub>, W termination with BID/DIR (RGH41B only)

61A = 20 MHz customer clock (RGH41N, W, Y and H only)

62A = 10 MHz customer clock (RGH41N, W, Y and H only)

63A = 5 MHz customer clock (RGH41N, W, Y and H only)

**NOTE:** Not all combinations are valid. Check valid options online at [www.renishaw.com/epc](http://www.renishaw.com/epc)

## Scale part numbers







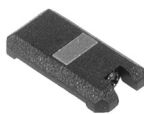

### RGS40-S

40 µm pitch lacquered tape scale with self-adhesive backing tape.

Part number	Available lengths	Available in increments of	Ordering instructions
<b>A-9537-3011</b>	100 mm to 50,000 mm*	1 mm	Ordering a quantity of 2455 will result in a length of 2455 mm (multiple orders are required for multiple lengths)
<b>A-9537-3010</b>	1 m to 50 m*	1 m	Ordering a quantity of 15 will result in a length of 15 metres (multiple orders are required for multiple lengths)
<b>A-9537-4xxx</b>	10 cm to 999 cm	1 cm	xxx is the length in cm (ordering A-9537-4450 for example will result in a length of 450 cm)
<b>A-9537-50xx</b>	10 m to 50 m*	1 m	xx is the length in metres (ordering A-9537-5033 for example will result in a length of 33 metres)

\*Lengths above 50 m are special order only. Please contact your local Renishaw representative.

## Accessory part numbers

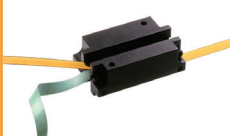
Part number	Description	Image
<b>A-9531-0250</b>	RGM22S reference mark actuator magnet – epoxy mounted. A reference sensor within the readhead is used to determine an absolute datum within an incremental measuring system. The sensor does this by detecting the external RGM22S reference mark actuator magnet as the readhead passes it.	
<b>A-9531-0287</b>	RGM22SB reference mark actuator magnet – screw mounted. A reference sensor within the readhead is used to determine an absolute datum within an incremental measuring system. The sensor does this by detecting the external RGM22SB reference mark actuator magnet as the readhead passes it.	
<b>A-9531-0251</b>	RGP22S limit switch actuator magnet 10 mm long – epoxy mounted. A limit sensor within the readhead detects end of travel by sensing the RGP22S limit switch actuator magnet.	
<b>A-9531-2052</b>	RGP22SM limit switch actuator magnet 24.35 mm long – epoxy mounted. A limit sensor within the readhead detects end of travel by sensing the RGP22SM limit switch actuator magnet.	
<b>A-9531-2054</b>	RGP22SL limit switch actuator magnet 50 mm long – epoxy mounted. A limit sensor within the readhead detects end of travel by sensing the RGP22SL limit switch actuator magnet.	
<b>A-9523-4015</b>	RGC-F end clamp kit – epoxy mounted. The RGC-F end clamps master the RGS scale to the substrate material to match its thermal expansion.	
<b>A-9531-0342</b>	RGG-2 2 part epoxy adhesive. The RGG-2 epoxy is recommended for the mounting of reference marks, limit switches and end clamps.	
<b>A-9531-0265</b>	RGA22 scale applicator kit (for RGS40-S lacquered scale). The RGA22 enables efficient and accurate scale application. It is particularly suited to long axes or limited access installations as the backing paper is automatically removed during scale application requiring minimal intervention.	
<b>A-9531-0239</b>	RGA22G scale applicator guide block (for RGS40-S lacquered scale). The RGA22G offers the benefits of RGA22 in a simplified form, and is ideally suited to shorter axes.	

For worldwide contact details, visit [www.renishaw.com/contact](http://www.renishaw.com/contact)

RENISHAW HAS MADE CONSIDERABLE EFFORTS TO ENSURE THE CONTENT OF THIS DOCUMENT IS CORRECT AT THE DATE OF PUBLICATION BUT MAKES NO WARRANTIES OR REPRESENTATIONS REGARDING THE CONTENT. RENISHAW EXCLUDES LIABILITY, HOWSOEVER ARISING, FOR ANY INACCURACIES IN THIS DOCUMENT.

© 2002-2019 Renishaw plc. All rights reserved.

Renishaw reserves the right to change specifications without notice.

RENISHAW and the probe symbol used in the RENISHAW logo are registered trade marks of Renishaw plc in the United Kingdom and other countries. apply innovation and names and designations of other Renishaw products and technologies are trade marks of Renishaw plc or its subsidiaries. All other brand names and product names used in this document are trade names, trade marks or registered trade marks of their respective owners.



L - 9517 - 9713 - 01

Part no.: L-9517-9713-01-E  
Issued: 11.2019