

IS1-2 interface selector installation guide

www.renishaw.com

IS1-2 interface selector installation guide

Document part number: H-1000-5085-08-B



IS1-2 interface selector installation guide

www.renishaw.com

General information

© 2001 - 2021 Renishaw plc. All rights reserved.

 ORIGINAL LANGUAGE VERSION

This document may not be copied or reproduced in whole or in part, or transferred to any other media or language by any means, without the prior written permission of Renishaw.

Disclaimer

WHILE CONSIDERABLE EFFORT WAS MADE TO VERIFY THE ACCURACY OF THIS DOCUMENT AT PUBLICATION, ALL WARRANTIES, CONDITIONS, REPRESENTATIONS AND LIABILITY, HOWSOEVER ARISING, ARE EXCLUDED TO THE EXTENT PERMITTED BY LAW.

RENISHAW RESERVES THE RIGHT TO MAKE CHANGES TO THIS DOCUMENT AND TO THE EQUIPMENT, AND/OR SOFTWARE AND THE SPECIFICATION DESCRIBED HEREIN WITHOUT OBLIGATION TO PROVIDE NOTICE OF SUCH CHANGES.

Trade marks

RENISHAW®, the probe symbol and REVO® are registered trade marks of Renishaw plc.

Renishaw product names, designations and the mark 'apply innovation' are trade marks of Renishaw plc or its subsidiaries.

Other brand, product or company names are trade marks of their respective owners.

WEEE



The use of this symbol on Renishaw products and / or accompanying documentation indicates that the product should not be mixed with general household waste upon disposal. It is the responsibility of the end user to dispose of this product at a designated collection point for waste electrical and electronic equipment (WEEE) to enable reuse or recycling. Correct disposal of this product will help to save valuable resources and prevent potential negative effects on the environment. For more information, please contact your local waste disposal service or Renishaw distributor.

Warranty

Unless you and Renishaw have agreed and signed a separate written agreement, the equipment and/or software are sold subject to the Renishaw Standard Terms and Conditions supplied with such equipment and/or software, or available on request from your local Renishaw office.

Renishaw warrants its equipment and software for a limited period (as set out in the Standard Terms and Conditions), provided that they are installed and used exactly as defined in associated Renishaw documentation. You should consult these Standard Terms and Conditions to find out the full details of your warranty.

Equipment and/or software purchased by you from a third-party supplier is subject to separate terms and conditions supplied with such equipment and/or software. You should contact your third-party supplier for details.

IS1-2 interface selector installation guide

www.renishaw.com

Care of equipment

Renishaw probes and associated systems are precision tools used for obtaining precise measurements and must therefore be treated with care.

Changes to Renishaw products

Renishaw reserves the right to improve, change or modify its hardware or software without incurring any obligations to make changes to Renishaw equipment previously sold.

Company registration details

Renishaw plc. Registered in England and Wales. Company no: 1106260. Registered office: New Mills, Wotton-under-Edge, Gloucestershire, GL12 8JR, UK.

Packaging

To aid end user recycling and disposal the materials used in the different components of the packaging are stated here:

Packaging component	Material	94/62/EC code	94/62/EC number
Outer box	Corrugated fibreboard	PAP	20
Packaging insert	Corrugated fibreboard	PAP	20
Bag	Low density Polyethylene	LDPE	4

IS1-2 interface selector installation guide

www.renishaw.com

Product compliance

EU declaration of conformity

Contact Renishaw plc or visit www.renishaw.com/EUCMM for the full EU declaration.

UK declaration of conformity

Contact Renishaw plc or visit www.renishaw.com/UKCMM for the full UK declaration.

EMC conformity

This equipment must be installed and used in accordance with this installation guide. This product is intended for industrial use only and should not be used in a residential area or connected to a low voltage power supply network which supplies buildings used for residential purposes.

FCC (USA only)

This equipment is supplied for use in industrial measurement systems and is not a digital device according to the Code of Federal Regulations title 47 part 15.3.

ICES-001 (Canada only)

This ISM device complies with Canadian ICES-001.

Cet appareil ISM est conforme à la norme ICES-001 du Canada.

REACH regulation

Information required by Article 33(1) of Regulation (EC) No. 1907/2006 ("REACH") relating to products containing substances of very high concern (SVHCs) is available at:

www.renishaw.com/REACH

IS1-2 interface selector installation guide

www.renishaw.com

China RoHS

Contact Renishaw plc or visit www.renishaw.com/ChinaRoHSCMM for the full China RoHS tabulation.



NRTL certification

The IS1-2 product has been independently tested to the relevant requirements of the following standards:

- UL 61010-1:2012/ R:2016-04
- CAN/CSA-C22.2 No. 61010-1:2012/U2:2016-04

The NRTL TÜV SÜD certification mark demonstrates compliance with these requirements.

IS1-2 interface selector installation guide

www.renishaw.com

Safety

 Where this symbol is displayed on the product the user must refer to the installation and user guide for information and safety advice.

If the equipment is used in a manner not specified by the manufacturer then the safety of the equipment may be impaired.

 **NOTE:** Clean equipment with a dry cloth only.

Electrical requirements

The IS1-2 is powered from the ac mains supply via an IEC 320 connector. The operating voltage range of the unit is as follows:

100 V - 240 V ac +10%, -15%	47 Hz - 66 Hz	10 W maximum
-----------------------------	---------------	--------------

Ensure that a suitable cable is always used that meet the requirements of the above operating conditions.

A standard IEC C13 cable assembly with a current rating of greater than 1 A must be used.

This equipment must be connected to a protective earth conductor via a three core mains (line) cable. The mains plug shall be inserted only into a socket outlet provided with a protective earth contact. The protective earth contact shall not be negated by the use of an extension cable without protective conductor.

 **WARNING:** Risk of electric shock – Any interruption in the protective conductor may make the equipment dangerous. Make sure that the grounding requirements are strictly observed.

The IS1-2 is isolated from ac power by disconnection of the IEC mains connector on the rear panel. If any additional means of isolation is required, it must be specified and fitted by the machine manufacturer or the installer of the product. The isolator must be sited within easy reach of the CMM operator and comply with IEC61010 and any applicable national wiring regulations for the country of installation.

IS1-2 interface selector installation guide

www.renishaw.com

Environmental conditions

The following environmental conditions comply with (or exceed) BS EN 61010-1:1993.

Indoor use	IP30 (no protection against water)
Altitude	Up to 2000 m
Operating temperature	+10 °C to +40 °C
Storage temperature	-10 °C to +70 °C
Relative humidity	80% maximum for temperatures up to +31 °C Linear decrease to 50% at +50 °C
Transient overvoltages	Installation category II
Pollution degrees	2

IS1-2 interface selector installation guide

www.renishaw.com

Introduction

The IS1-2 interface selector is a fully automatic system for use on coordinate measuring machine (CMM) installations requiring multiple sensor types (e.g. SP25M - scanning probe, TP7M - strain gauge probe, OTP6M - optical trigger probe etc.). The unit functions by identifying which probe has been fitted to the probe head and switches the probe signal / power lines to the appropriate interface.

This guide describes how the IS1-2 (interface selector) functions when used with multiple Renishaw probing systems. It gives information on physical installation, system connections and interface settings, as well as assistance in fault finding during the installation of a system. The guide should be read in conjunction with the associated product documentation for the Renishaw equipment that is used within the multiple sensor probing system.

IS1-2 interface selector installation guide

www.renishaw.com

System description

The system comprises an IS1-2 standalone or rack-mountable interface selector.

The IS1-2 has four separate channel outputs. These outputs allow any combination of the following Renishaw probes to be integrated into one automated system:

- SP25M
- SP80
- TP7M
- SP600
- OTP6M*
- TP200*
- TP2 / TP6 / TP20*

The IS1-2 is also fully compatible with Renishaw's ACR1 and ACR3 probe autochange systems, the PH10M PLUS range of motorised heads and the PHS motorised servo head system using the Renishaw product interconnection system (PICS).

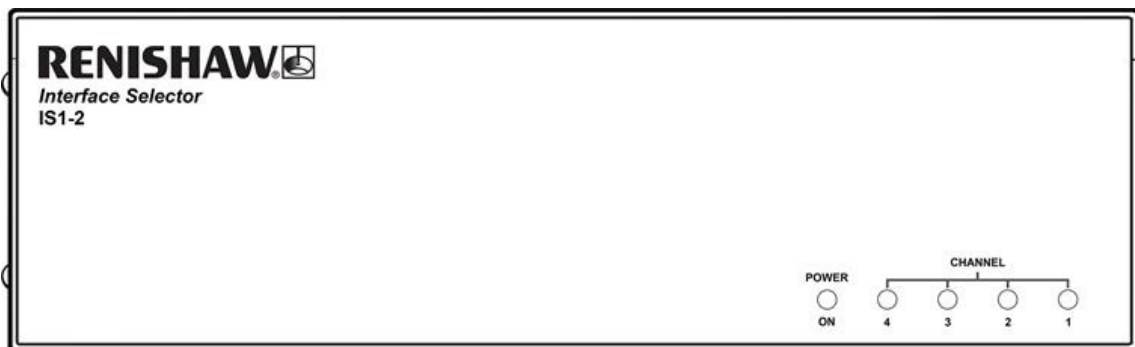

* These probes can be incorporated into a multiple sensor system consisting of any one of the other probe systems specified without the necessity to use a IS1-2 unit. Please contact Renishaw for further details.

IS1-2 interface selector installation guide

www.renishaw.com

System components

Programming modules

A programming module for each of the following Renishaw standard multiwired products are supplied pre-installed within the IS1-2 channels:

Channel 1	TP7M
Channel 2	SP600M
Channel 3	SP80
Channel 4	SP25M

An OTP6M module will be supplied in the IS1-2 kit.

Plugging the required product module into the correct channel selector socket ensures that the probe connections are made to the correct IS1-2 output port.

Third party probes, that carry the female autojoint, require specific identification resistors to be fitted within the autojoint. Special modules to permit the recognition of these probes by the IS1-2 will also be required (please contact Renishaw for further details).

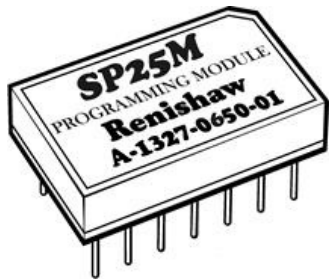

IS1-2 interface selector installation guide

www.renishaw.com

Probe / channel identification labels

The probe identifier labels (SP25M, SP80, TP7, OTP6M, SP600 etc) are designed to be applied to the front panel of the IS1-2 and the respective probe interface labels (AC3, IU80, PI 7-2, OPI6, AC2 etc.) are designed to be applied to the rear panel of the IS1-2 unit.

Front panel with labels - default configuration:

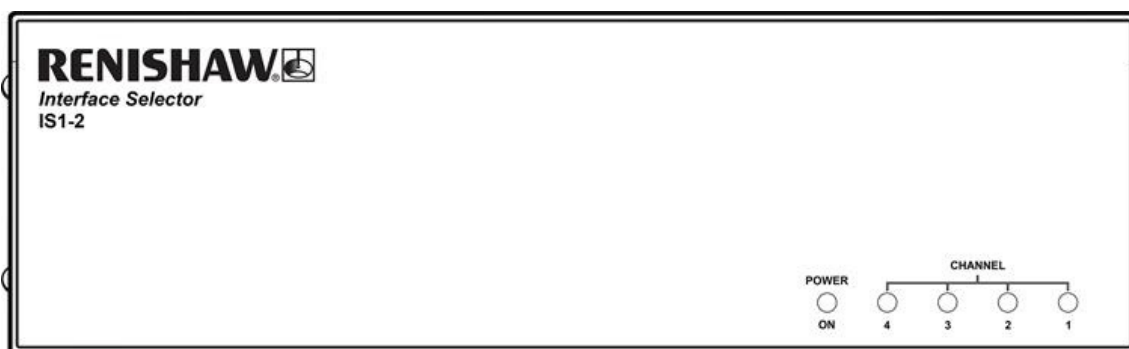

Rear panel with labels - default configuration:

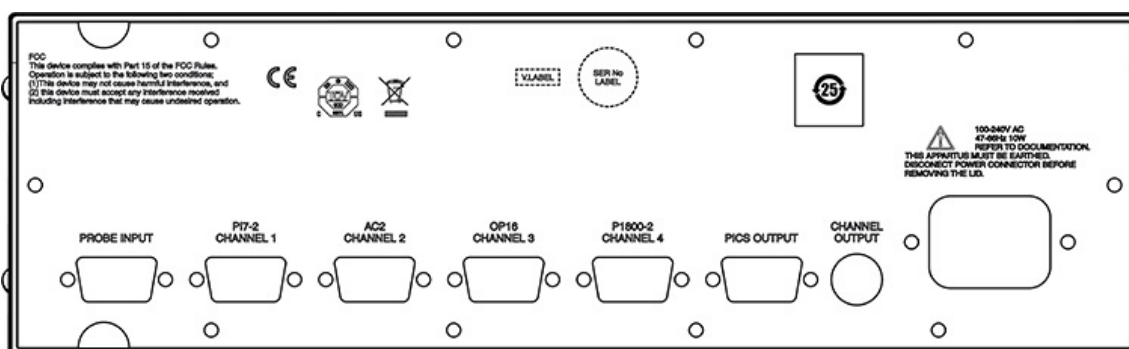

Identification labels:

3K7	3K7	TP2
4K7	4K7	TP20
11K	11K	TP6
21K8	21K8	TP200
OTP6M	OPI6	AC1
SP25M	ACR3	PI 200-2
SP80	IU80	
SP600M	AC2	
TP7M	PI 7-2	

IS1-2 interface selector installation guide

www.renishaw.com

Installation

Front panel of IS1-2



Key	Description
1 - 4	Output channel selected indicators
5	Power on indicator

Output channel selected indicators (1 - 4)

These yellow LEDs are lit to indicate which channel is activated within the IS1-2 unit.

Power on indicator (5)

This green LED is lit when power is applied to the IS1-2 unit.

IS1-2 interface selector installation guide

www.renishaw.com

Rear panel of IS1-2

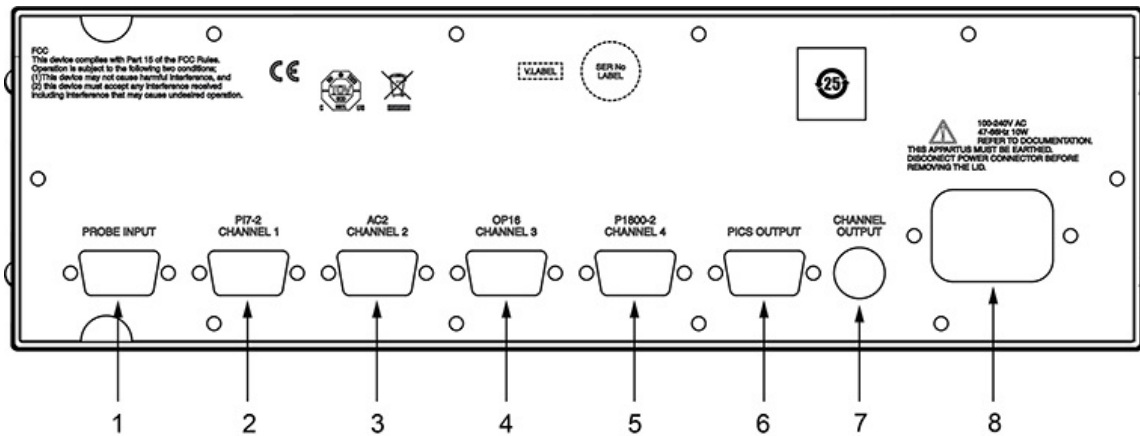

Key	Description	Key	Description
1	Probe input port	5	IS1-2 output channel 4
2	IS1-2 output channel 1	6	PICS output
3	IS1-2 output channel 2	7	IS1-2 channel output
4	IS1-2 output channel 3	8	Mains power input

Probe input port (1)

This 15-way high density 'D' socket is the connection from the multiwire cable to the IS1-2.

The function of each pin is dependent on the probe that is connected, but the table below indicates general connection details:

Probe input connections:

Pin	Designation	Pin	Designation
1	Uncommitted	9	Co-axial screen
2	Screen	10	75 Ohm co-axial inner
3	2 wire probe signal / probe ident return	11	Uncommitted
4	Uncommitted	12	Uncommitted
5	Uncommitted	13	2 wire probe signal
6	Uncommitted	14	Fixed head LED anode
7	Uncommitted	15	Fixed head LED cathode
8	Probe ident		

IS1-2 interface selector installation guide

www.renishaw.com

PICS output port (2 - 5)

These 15-way high density 'D' plugs are the connections from the IS1-2 unit to the appropriate probe interface as specified by the programming module.

The function of each pin is specified in above.

PICS output (6)

This 9-way 'D' plug maintains compatibility with the Renishaw product interconnection systems (PICS).

As the IS1-2 is neither a probe interface or a controller the only connection that is activated is STOP.

The table below indicates the PICS output connections.

IS1-2 PICS connections:

Pin	Designation	Pin	Designation
1	STOP	6	Not connected
2	Not connected	7	Not connected
3	0 V reference	8	Not connected
4	Not connected	9	Not connected
5	Not connected		

IS1-2 interface selector installation guide

www.renishaw.com

IS1-2 channel output (7)

This 6-way mini DIN socket can be used to give an electrical indication of which output is selected.

The electrical output levels conform to the Renishaw PICS specification, i.e. outputs 1 to 4 are normally high (+5 V) and are pulled low when the appropriate interface channel is selected.

The table below gives the pin numbers and their function.

IS1-2 channel output:

Pin	Designation	Pin	Designation
1	Channel 1 selected	4	Channel 4 selected
2	Channel 2 selected	5	0 V
3	Channel 3 selected	6	Not connected

These outputs are open collector devices with 3K3 pullup resistors and the following characteristics:

ON	0.4 V max @ $I_c = 15 \text{ mA}$
OFF	Leakage current = 0.25 mA max @ $V_{ce} = 5.25 \text{ V}$

Installation of programming modules

The IS1-2 comes with four programming modules pre-installed. If it is necessary to change the programming modules please refer to the 'Changing the programming modules default configuration' section below.

Default configuration

When the IS1-2 unit is received the programming modules will have been installed into the unit in the configuration as follows:

Channel 1	Configured for TP7M
Channel 2	Configured for SP600M analogue scanning probe
Channel 3	Configured for SP80 analogue scanning probe
Channel 4	Configured for SP25M analogue scanning probe



NOTE: TP2, TP6, TP20 and TP200 probe signals will always be connected to channel 1, this is independent of the programming module fitted (if any).

The respective probe and interface identification labels for the modules fitted can be attached to the front and rear panels of the IS1-2 unit.

IS1-2 interface selector installation guide

www.renishaw.com

Changing the programming modules default configuration

CAUTION: Risk of electric shock - To re-configure the IS1-2 programming modules it is necessary to remove the top cover of the IS1-2 unit. The mains power connection must be removed from the unit prior to removing the lid.

The suggested procedure to change the programming modules:

1. Remove power lead from IS1-2.
2. Remove the top panel from the IS1-2.
 - This is done by removing the four screws on the top edge of the rear panel:

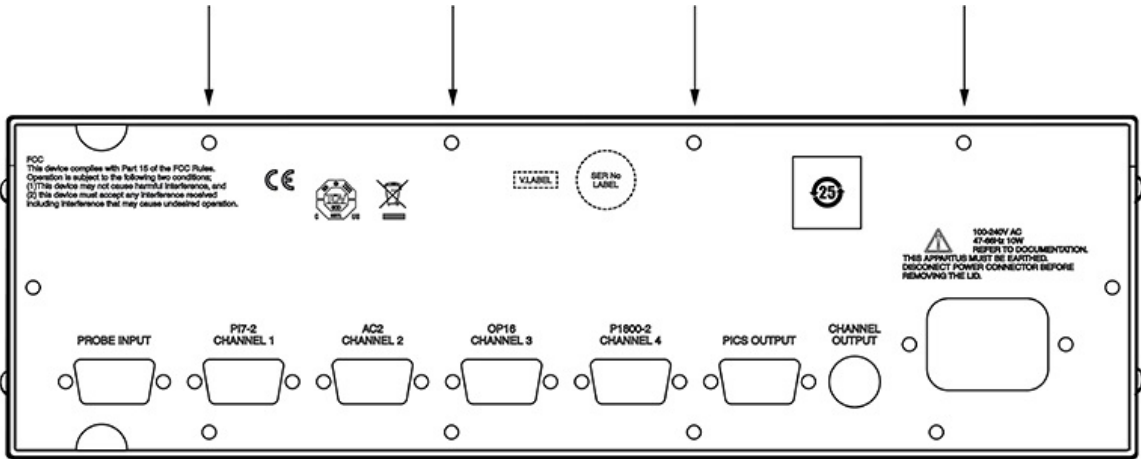

- Then remove the retaining screw on each side of the box:

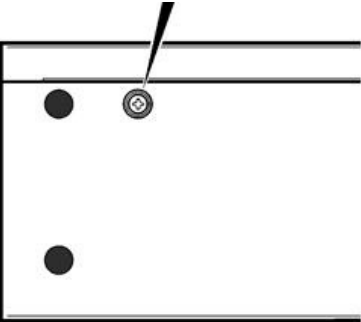

IS1-2 interface selector installation guide

www.renishaw.com

3. Lift lid vertically to remove from enclosure.

- Position the IS1-2 programming modules into the required position, note the programming module orientation with respect to the IS1-2.

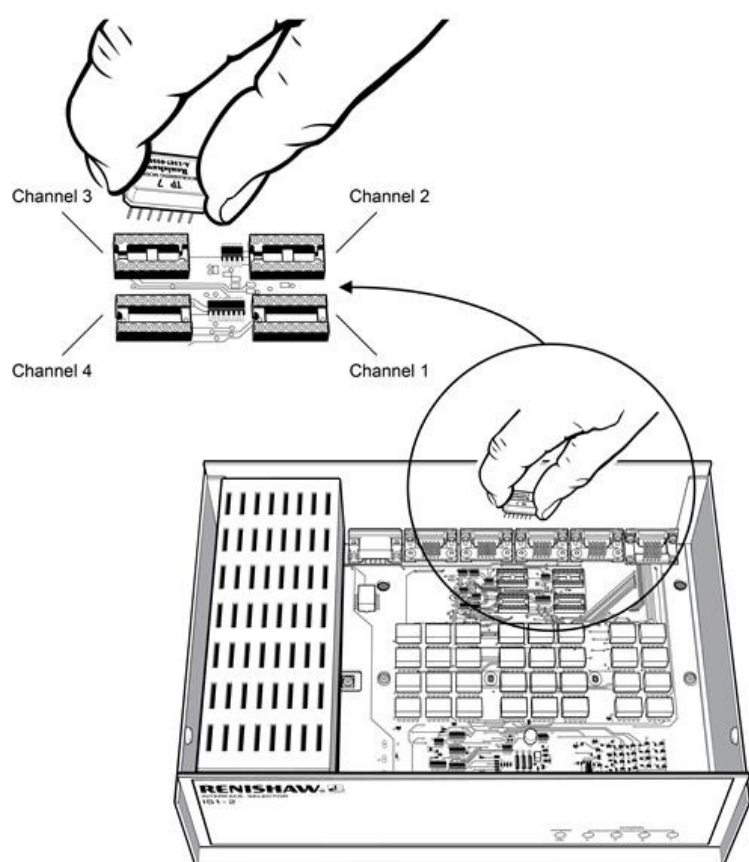

- Replace the top panel following the reverse of steps 1, 2 and 3.

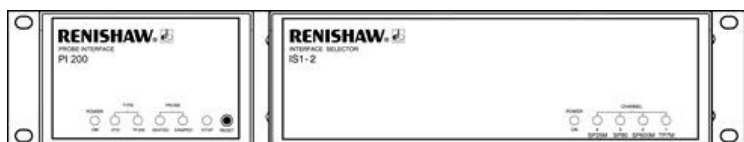

NOTE: SP80 must not be used in channel 4.

Stand-alone installation

Four self-adhesive rubber feet are supplied with the unit for stand-alone use.

IS1-2 interface selector installation guide

www.renishaw.com

Mounting alone in a 19" rack

WARNING: Risk of electric shock - In all installations ensure the IS1-2 is disconnected from the mains supply during installation.

WARNING: Risk of thermal damage to product - Take care not to exceed the operation ambient of 40 °C around the unit. Do not install near sources of heat. Forced cooling may be required in final installation.

NOTE: In all installations use the mounting screws supplied with the equipment. Do not replace with longer screws as damage can occur.

The figure below shows the IS1-2 ready for mounting to a 19" rack.



Remove the blanking plugs from the side panels of the IS1-2 and fit the blanking panel (2) and rack mounting bracket (1) using the screws supplied as shown in the following figure.

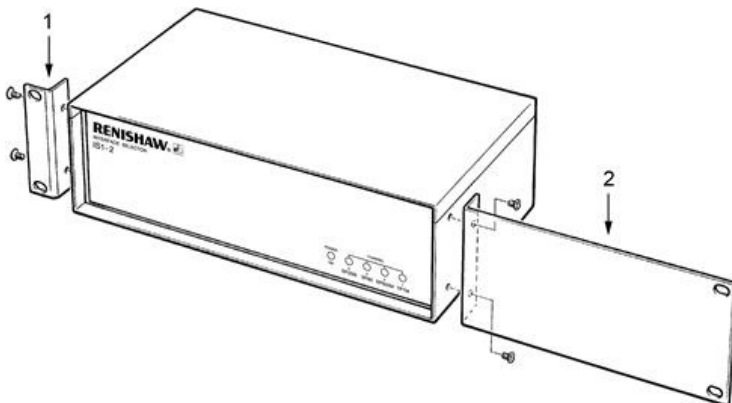

The rack mounting bracket kit is part number A-1018-0124. The blanking panel kit is part number A-1018-0123.

Mounting next to an interface

The figure below shows the IS1-2 with a PI 200 interface ready for mounting to a 19" rack.

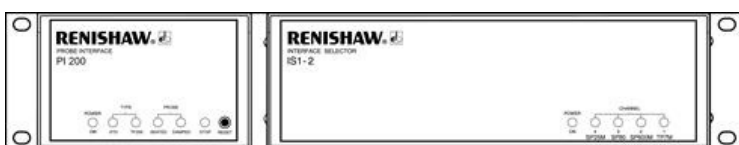

IS1-2 interface selector installation guide

www.renishaw.com

System interconnection

The figure below shows schematically how combinations of probes, probe heads and autochange can be integrated into one system using the IS1-2.

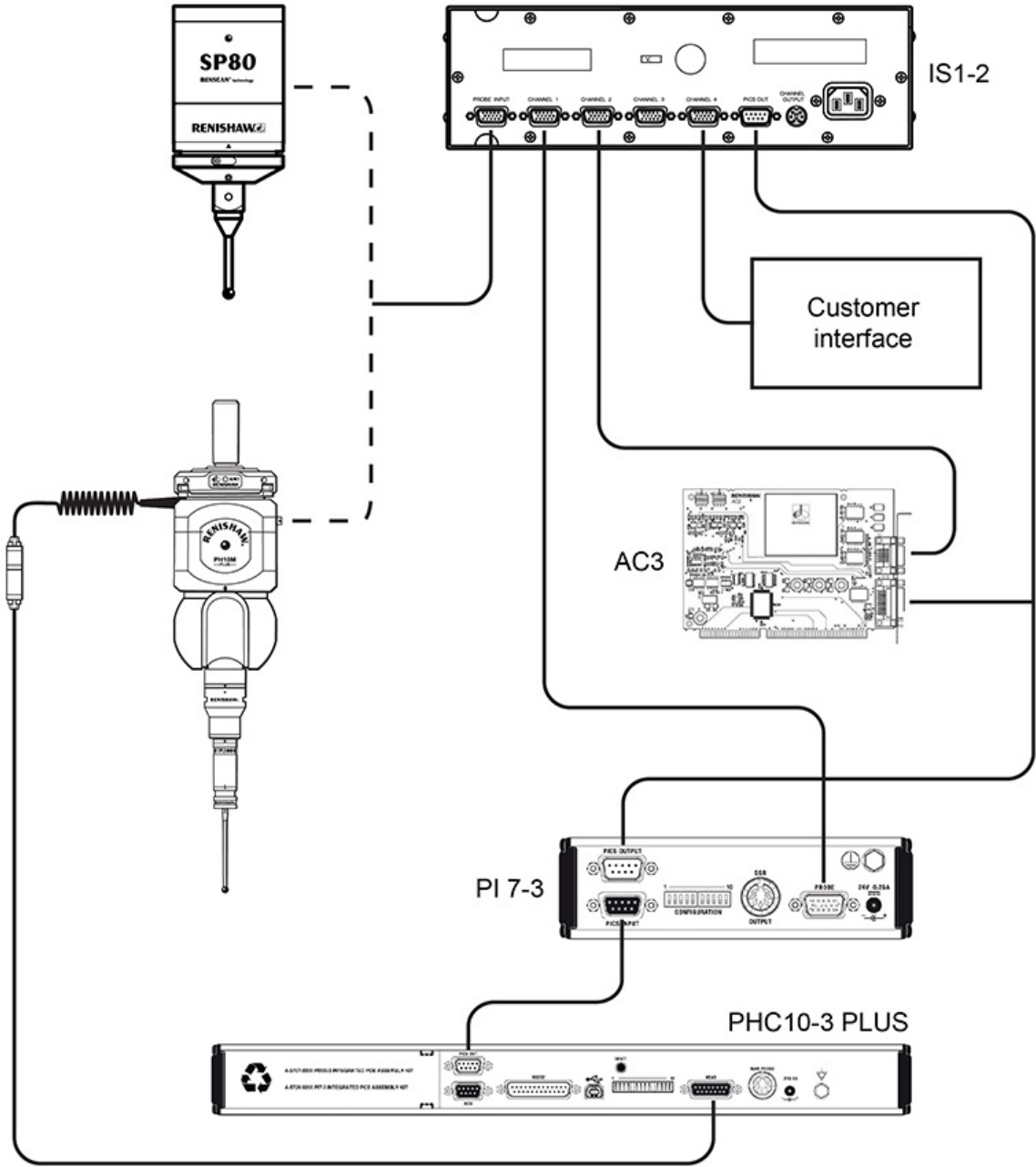

IS1-2 interface selector installation guide

www.renishaw.com

Please contact Renishaw if the system you are connecting together incorporates any of the following:

- A PI 7 probe interface that was manufactured before August 1993
- Any component of the Renishaw OP5 system, which was made obsolete during 1995
- A PI 12 probe interface
- VPI 1 or VPI 2 video probe interface
- Any non-Renishaw probes that carry the female autojoint

IS1-2 interface selector installation guide

www.renishaw.com

Rules of installation

Although, in theory, the IS1-2 can be programmed to output a particular probe signal from any output connector, the following conditions and restrictions apply:

- TP2, TP6, TP20 and TP200 probe signals will always be connected to channel 1, independent of the programming module fitted (if any)
- If no probes are connected to the IS1-2 input, the probe signal from channel 1 will emulate a conventional triggered touch probe
- If a TP200 forms part of the system, a PI 200-3 must be connected to the IS1-2 channel 1 either by itself (no programming module required) or in combination with another interface
- To interface conventional TP2, TP6 and TP20 probes, an interface capable of interfacing these probe must be connected to the IS1-2 channel 1, such as PI 4-2

Renishaw plc
New Mills, Wotton-under-Edge
Gloucestershire, GL12 8JR
United Kingdom

T +44 (0)1453 524524
F +44 (0)1453 524901
www.renishaw.com/cmmsupport



**For worldwide contact details,
please visit our main website at
www.renishaw.com/contact**