

SPA2 servo power amplifier

© 2006 Renishaw plc. All rights reserved.

This document may not be copied or reproduced in whole or in part, or transferred to any other media or language, by any means, without the prior written permission of Renishaw.

The publication of material within this document does not imply freedom from the patent rights of Renishaw plc.

Disclaimer

Considerable effort has been made to ensure that the contents of this document are free from inaccuracies and omissions. However, Renishaw makes no warranties with respect to the contents of this document and specifically disclaims any implied warranties. Renishaw reserves the right to make changes to this document and to the product described herein without obligation to notify any person of such changes.

Trademarks

RENISHAW® and the probe emblem used in the RENISHAW logo are registered trademarks of Renishaw plc in the UK and other countries.

apply innovation is a trademark of Renishaw plc.

All brand names and product names used in this document are trade names, service marks, trademarks, or registered trademarks of their respective owners.

SPA2

Installation guide

CE

FCC

Information to user (FCC section 15.105)

This equipment has been tested and found to comply with the limits for a class A digital device, pursuant to part 15 of the FCC rules. These limits are designed to provide reasonable protection against harmful interference when the equipment is operated in a commercial environment. This equipment generates, uses and can radiate radio frequency energy and, if not installed and used in accordance with the installation manual, may cause harmful interference to radio communications. Operation of this equipment in a residential area is likely to cause harmful interference, in which case you will be required to correct the interference at your expense.

Information to user (FCC section 15.21)

The user is cautioned that any changes or modifications not expressly approved by Renishaw PLC or authorised representative could void the user's authority to operate the equipment.

EC declaration of conformity

Renishaw plc declare that the product: -

Name	Description
SPA2	Servo amplifier

has been manufactured in conformity with the following standards: -

BS EN 61326:1998/ inc. amendments A1:1998/A2:2001	Electrical equipment for measurement, control and laboratory use - EMC requirements. Immunity to annex A - industrial locations. Emissions to class A (non-domestic) limits.
BS EN 61010-1:2001	Safety requirements for electrical equipment for measurement, control and laboratory use. Part 1: General requirements.
BS EN 60204-1:1998	Safety of machinery - Electrical equipment of machines - Part 1: General requirements

and that it complies with the requirements of directives (as amended): -

89/336/EEC	- Electromagnetic compatibility (EMC)
73/23/EEC	- Low voltage

The above information is summarised from the full EC declaration of conformity. A copy is available from Renishaw on request.

Care of equipment

Renishaw probes and associated systems are precision tools used for obtaining precise measurements and must therefore be treated with care.

Changes to Renishaw products

Renishaw reserves the right to improve, change or modify its hardware or software without incurring any obligations to make changes to Renishaw equipment previously sold.

Warranty

Renishaw plc warrants its equipment for a limited period (as set out in our Standard Terms and Conditions of Sale) provided that it is installed exactly as defined in associated Renishaw documentation.

Prior consent must be obtained from Renishaw if non-Renishaw equipment (e.g. interfaces and/or cabling) is to be used or substituted. Failure to comply with this will invalidate the Renishaw warranty.

Claims under warranty must be made from authorised service centres only, which may be advised by the supplier or distributor.

Machine safety



WARNING: Switching off or isolating the **SPA2** may NOT prevent unexpected machine movement. The user is advised to isolate the machine from the electricity supply, compressed air or other energy sources in accordance with the machine manufacturer's instructions before entering the danger zone or performing any maintenance operations.

If the equipment is used in a manner not specified by the manufacturer, the protection provided by the equipment may be impaired.

References and associated documents

It is recommended that the following documentation is referred to when installing the **SPA2**.

Renishaw documents

Documentation supplied on Renishaw UCC software CD.

Document number	Title
H-1000-5223	UCC2 controller installation guide
H-1000-5057	UCC controller programmer's guide
H-1000-5058	RENICIS user's guide
H-1000-5067	MCU installation and user's guide
H-1000-5109	UCC<i>lite</i> installation guide
H-1000-5227	Digital SPA tuning user's guide

External documents

National and international standards including the following may be applicable to the finished machine or installation:

- BS EN ISO 12100-2:2003 (Safety of machinery - Basic concepts, general principles for design - Part 2: Technical principles and specifications).
- BS EN (IEC) 60204-1:1997 (Safety of machinery - Electrical equipment of machines - Part 1: General requirements).

Electrical requirements

The **SPA2** is powered from the a.c. mains supply via an IEC 320 connector. The electrical ratings of the unit are as follows:

100 – 240 V ac +10%, -15% 47 – 63 Hz 650 W maximum

This equipment must be connected to a protective earth conductor via a three core mains (line) cable. The mains plug shall be inserted only into a socket outlet provided with a protective earth contact. The protective earth contact shall not be negated by the use of an extension cable without protective conductor.

An earth stud (M5 thread) is provided to allow bonding of the CMM metal parts to the protective earth.



WARNING: Any interruption of the protective conductor may make the equipment dangerous. Make sure that the grounding requirements are strictly observed.

Environmental requirements

The following environmental conditions comply with (or exceed) BS EN 61010-1:1993

Indoor use	IP20 (no protection against water)*
Altitude	up to 2000 m
Operating temperature	0 °C to +50 °C (local to SPA2)
Storage temperature	-10 °C to +70 °C
Relative humidity	80% maximum (non-condensing) for temperatures up to +31 °C. Linear decrease to 50% at +40 °C
Transient overvoltages	Installation category II
Pollution degree	2
Weight	8 kg (17.6 lb)

NOTE: If a higher IP rating is required an additional external enclosure will be required to house the **SPA2**. This enclosure must facilitate an airflow to allow the internal temperature to maintain the ambient within the **SPA2** operating range.

Contents

1	System description	9
1.1	Electrical specification	10
1.2	SPA2 system components	10
1.2.1	SPA2 DC motor kits	10
1.2.2	SPA2 DC motor connector kit	11
1.2.3	SPA2 encoder interface card kit	11
1.2.4	SPA2 4 th axis interface card kit	11
1.2.5	Dual SPA2 integration kit	12
1.2.6	SPA2 DC connector kit	12
1.2.7	SPA2 and UCC2 system layout	13
1.2.8	SPA2 and UCC <i>lite</i>	13
2	Front panel description	14
2.1	Axes status LEDs	14
2.1.1	LED positions and axis link 3 axis / 6 axis	14
2.2	ESTOP LED	14
2.3	Air cooling fan inlet	14
3	Rear panel description.....	15
3.1	Rear panel – 3 axis system	15
3.2	Rear panel – 6 axis system	16
3.3	Connections	16
3.3.1	Encoder card.....	16
3.3.2	Motor connector	17
3.3.3	Mains connection	17
3.3.4	UCC2 emergency stop connection	17
3.3.5	SPA-A/-B/-C/-D connections.....	17
3.3.6	Earth stud.....	18
3.3.7	External emergency stop connection.....	18
3.4	Motor connectors	19
3.4.1	DC motor connection card termination	19
3.4.2	Additional axis interface card termination	20
3.5	Encoder interface card	21
4	Hardware configuration of the SPA2	22
4.1	Fitting a motor connection card.....	22
4.1.1	Recommended procedure to install the motor connection cards	22
4.2	Installing the encoder option card	24
4.2.1	Recommended procedure to install the encoder interface card	24
4.3	Fitting the 4 th axis option card	26

4.3.1	Recommended procedure to install the 4 th axis interface card	26
4.4	Mounting the SPA2.....	29
4.4.1	Stand alone mounting	29
4.4.2	Mounting in a 19" rack.....	29
5	System installation.....	30
5.1	General.....	30
5.2	Testing and verification	30
6	Interconnection schemes.....	31
6.1	UCC2 DC motor and tacho connection	31
6.2	UCCLite DC motor and tacho connection	32
6.3	Dual SPA2 DC motor and tacho configuration	33
6.4	Preparation of integration kits.....	34
6.4.1	Motor connectors	34
6.4.2	Emergency stop and reset switch	35
7	Revision history.....	36

1 System description

The **SPA2** is a digital servo power amplifier solution designed specifically for use with the Renishaw **UCC2** or **UCClite** controller.

The **SPA2** is capable of controlling up to seven axes of movement but is customer configurable to the requirements of the installation.

The features offered by the **SPA2** are:

- **Two base units**
 - **SPA2 3-axis:** This is the basic 3-axis configuration suitable for conventional CMMs fitted with brushed dc motors. It can accommodate both tacho and tacholess velocity feedback systems and, with the addition of an encoder interface card, it can also accommodate encoder velocity feedback. An additional axis card can be fitted to extend this unit to a 4-axis system.
 - **SPA2 6-axis:** This configuration is suitable for installations requiring between 5 or 6 axis amplifiers. Like the 3-axis version it can accommodate both tacho and tacholess velocity feedback systems and, with the addition of encoder interface cards, it can also accommodate encoder velocity feedback. An additional axis card can be fitted to extend this unit to a 7-axis system.
 - Two **SPA2** units can be combined in a single system permitting a servo power amplifier solution with an overall power rating of 1200 W.
- **Configurable motor voltage**
 - The **SPA2** motor voltage can be configured by software to support a wide range of motor voltages within the range of 12 and 60 V. The current limit can also be configured up to a maximum of 5 A continuous, 10 A peak.
 - The voltage setting of each axis is independent and therefore it is possible to have each machine motor driven by a different voltage.
- **DC analogue tacho or tacholess compatibility**
 - The **UCC2** or **UCClite** and **SPA2** control solution has the ability to support different types of velocity control loop based on the feedback to the controller.
 - Two control loop feedback methods are integrated into the standard design of the system, these are either an analogue tacho based feedback system from the motor or obtaining the feedback from the scales of the CMM.
- **Optional encoder (digital) tacho compatibility**
 - The **SPA2** offers the ability to support encoder tacho based feedback to close the velocity control loop as an optional interface card.

NOTE: The **UCClite** product only permits 3-axis of machine control.

1.1 Electrical specification

The **SPA2** has the following electrical output specification:

Motor output voltage range	12 V to 60 V
Maximum peak current output per channel (peak current for ≤ 50 s at a duty cycle of $\leq 20\%$)	10 A
Maximum continuous current output per channel (operating)	5 A
Maximum output wattage of whole SPA2	600 W
Emergency stop system specification	Category 2 to EN 954-1:1996 (ISO 13849-1:1999) (refer to section 6.4.2)

1.2 SPA2 system components

The **SPA2** family of products are capable of being configured to enable support of a wide range of motor and tacho feedback giving compatibility with most machine constructions.

Part number	Description	Number of axis supported	Refer to
A-5121-0010	SPA2 3-axis DC motor kit	3	1.2.1
A-5121-0012	SPA2 6-axis DC motor kit	6	1.2.1
A-5121-0023	SPA2 Revo kit	3 + Revo	1.2.1
A-5121-0018	SPA2 DC motor connector kit	3	1.2.2
A-5121-0014	SPA2 encoder interface card kit	4	1.2.3
A-5121-0015	SPA2 4 th axis interface card kit	1	1.2.4
A-5121-0016	Dual SPA2 integration kit	6	1.2.5
A-5121-0028	SPA DC connector kit	3	1.2.6

1.2.1 SPA2 DC motor kits

These kits contain all the necessary components to connect the **SPA2** to either the Renishaw **UCC2** or **UCClite** controller and to a CMM fitted with brushed DC motors with a tacho or tacholess velocity feedback system.

These kits contain the following components:

	A-5121-0010 SPA2 3-axis DC	A-5121-0012 SPA2 6-axis DC	A-5121-0023 SPA2 3-axis Revo
3-axis SPA2	1	-	-
6-axis SPA2	-	1	1
DC motor connector I/F	3	6	3
Revo connector I/F	-	-	1
UCC2 or UCClite to SPA2 comms cable	2	3	4
Emergency stop cable	1	1	1

1.2.2 SPA2 DC motor connector kit

This kit contains the motor output connection cards to permit three DC motors to be connected to the **SPA2** unit. Normally these would be supplied with the SPA unit and do not need to be ordered separately, unless you are converting an existing system.

1.2.3 SPA2 encoder interface card kit

This kit contains the optional encoder interface card for the **SPA2** system, this permits connection of up to 4 encoder (digital) motor feedback systems.

NOTE: Each **SPA2** unit can only support one encoder interface card permitting:

- four encoder inputs on a 3 + 1 axis system (using 4th axis card)
 - three encoder inputs on a 6 axis system
-

This kit contains the following components:

- 1 off **SPA2** encoder interface card
- 1 off internal connection loom

1.2.4 SPA2 4th axis interface card kit

This kit contains the optional 4th axis interface card for the **SPA2** system. This permits connection of an additional machine axis to the **SPA2** when using the **UCC2** controller.

NOTE: Each **SPA2** unit can only support one 4th axis interface card.

This kit contains the following components:

- 1 off 4th axis interface card
- 1 off internal connection loom
- 1 off internal connection power loom
- 4th axis hardware mounting kit
- 1 off mating motor connector for machine wiring

1.2.5 Dual SPA2 integration kit

This cable kit is designed to permit a high power solution for CMM installations where the power capacity of a single **SPA2** will not address the requirements for the machine.

This system enables two **SPA2** units to be combined in a single system and configured to drive the CMM installation (e.g. if required a single **SPA2** can power a single axis, or if in a dual drive configuration the two dual axis motors by supplied from separate **SPA2** units and the other two axis be integrated such that each **SPA2** drives two motors).

This kit contains the following component:

- 1 off **UCC2** to dual **SPA2** emergency stop connection cable

1.2.6 SPA2 DC connector kit

This kit has been designed to assist in the connection of either a **UCC2** or **UCClite** and **SPA2** to a machine installation.

This kit contains the following components:

- 3 off 7W2 motor connectors including backshells to permit connection of the motor and analogue tacho signals to the **SPA2**
- 1 off 9-way D connector including backshell to permit the connection of an external emergency stop device to the Renishaw emergency stop chain

1.2.7 SPA2 and UCC2 system layout

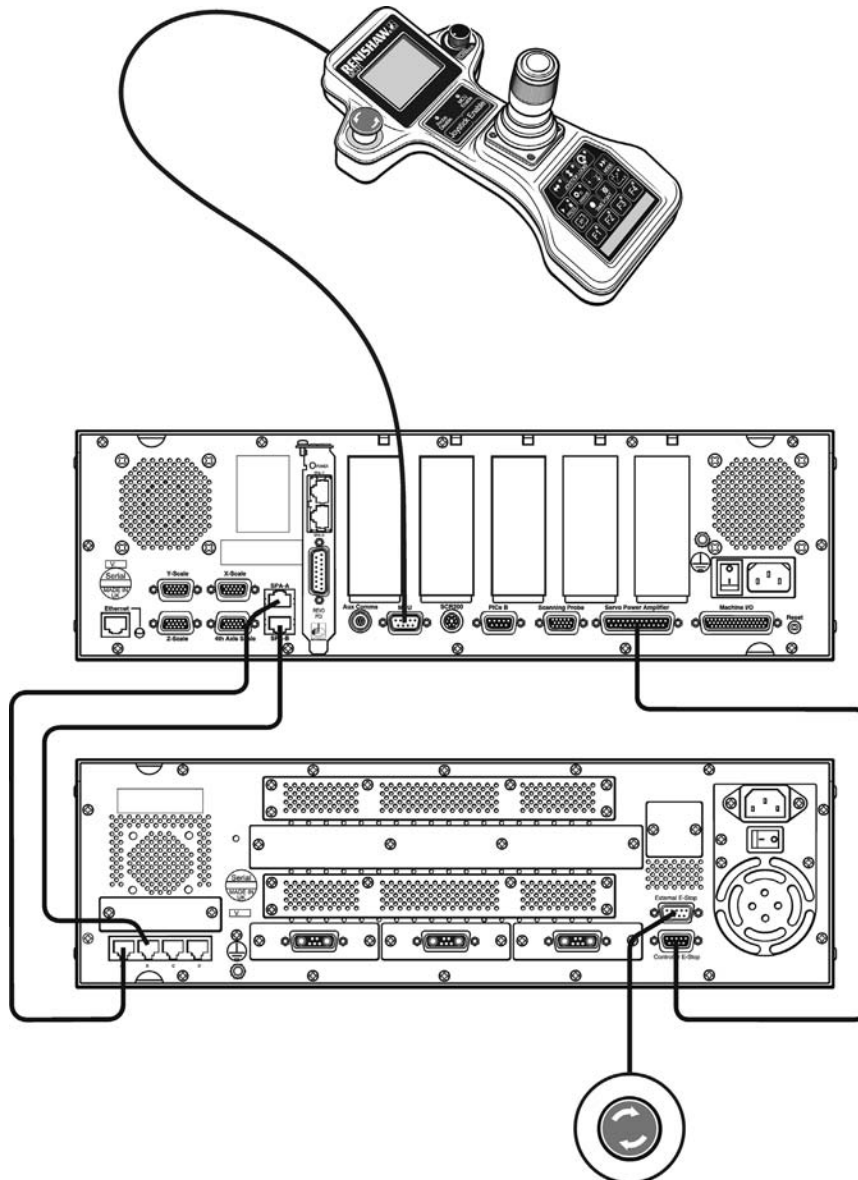

1.2.8 SPA2 and UCC*lite*

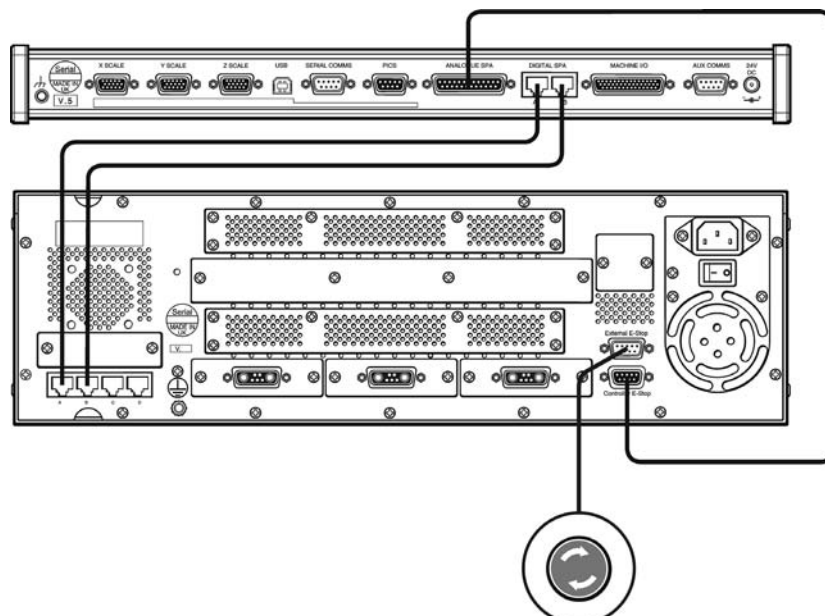

2 Front panel description

The diagram below shows the front panel of the **SPA2**:

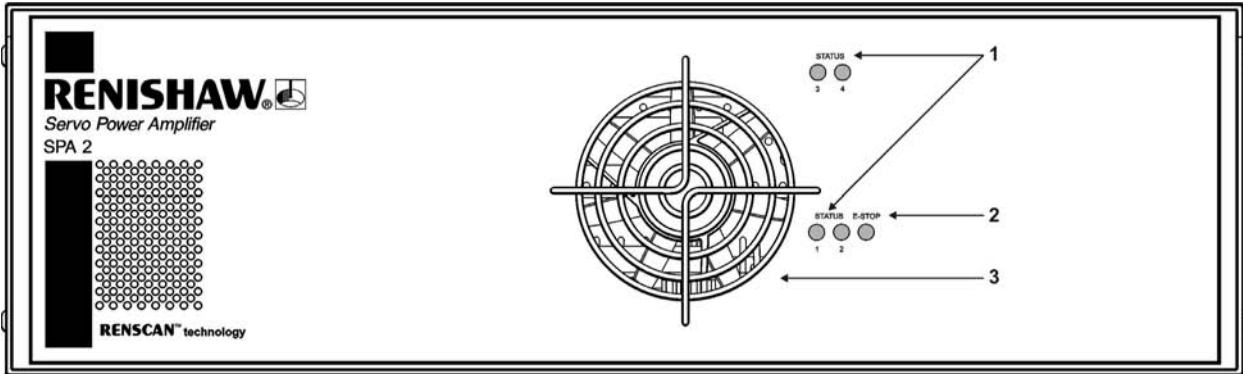

Key

1. Axes status LEDs
2. ESTOP LED
3. Air cooling fan inlet

2.1 Axes status LEDs

2.1.1 LED positions and axis link 3 axis / 6 axis

These LEDs indicate the status of the servo engagement within the **SPA2** unit as shown in the table below:

Axis status LED colour	System status
Off	The SPA2 has no power being applied to the system
Orange	The servo system is active but not engaged for this axis
Green	The servo system is engaged for this axis
Red	There is a fault on this axis of the system

Status 1 indicates the status of axis 0 and 1, status 2 indicates the status of axis 2 and 3 (if fitted), status 3 indicates the status of axis 4 and 5 of a 6 axis system and status 4 indicates the status of axis 6.

2.2 ESTOP LED

This red LED indicates if the emergency stop system has been activated.

2.3 Air cooling fan inlet

The **SPA2** requires air cooling, the inlet being through this fan.

The airflow to the fan must not be obstructed. A minimum of 50 mm clearance in front of the fan is required.

3 Rear panel description

When the **SPA2** is delivered it will be in a configurable format and it will be necessary for the motor connection cards to be fitted by the installer prior to applying power.

3.1 Rear panel – 3 axis system

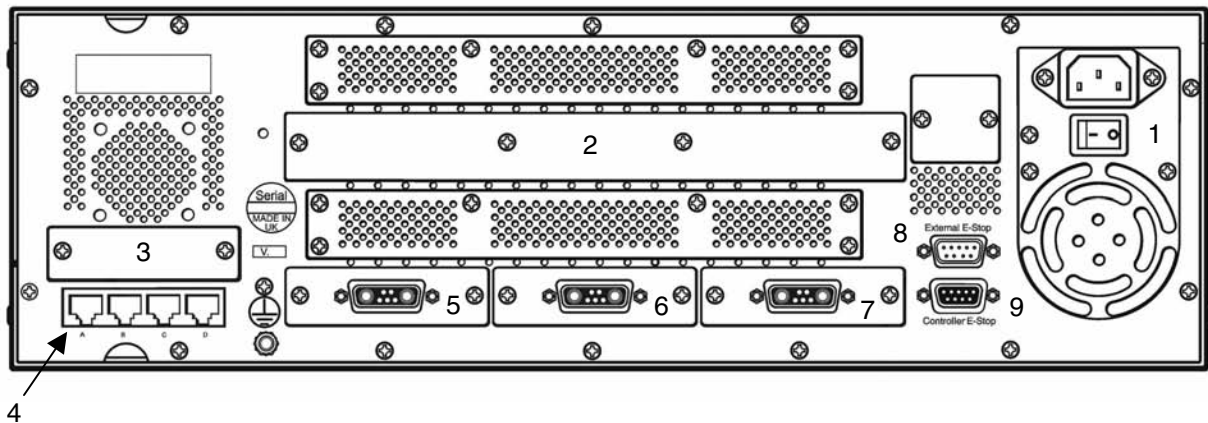

Key	Description	Refer to section
1	Power input and ON/OFF switch	3.3.3
2	Axis 0-3 encoder tachometer input connectors	3.3.1
3	Axis 3 motor input connector (optional)	3.3.2
4	UCC2 and UCClite communication link connectors	3.3.5
5	Axis 2 motor input connector	3.3.2

Key	Description	Refer to section
6	Axis 1 motor input connector	3.3.2
7	Axis 0 motor input connector	3.3.2
8	External emergency stop and reset connector	3.3.7
9	UCC2 and UCClite emergency stop connector	3.3.4
10	Earth stud	3.3.6

3.2 Rear panel – 6 axis system

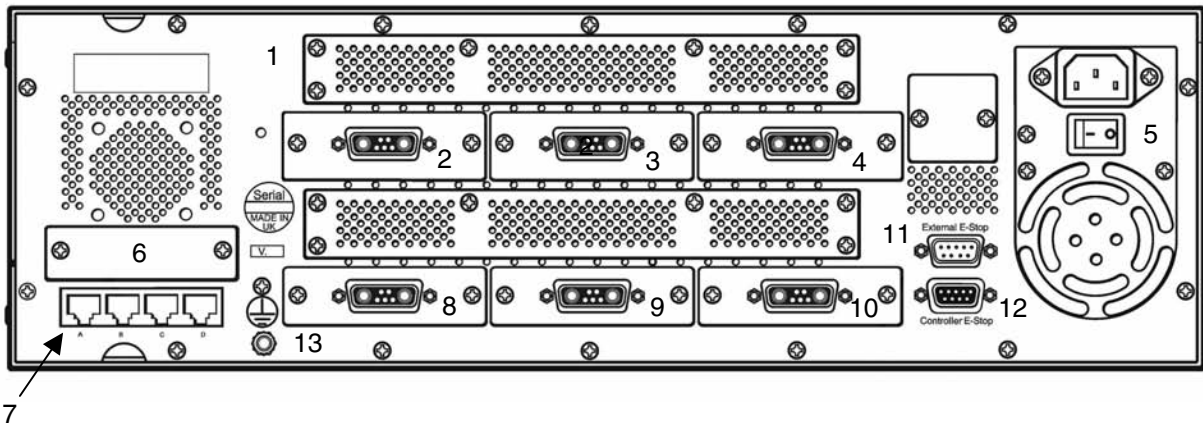

Key	Description	Refer to section
1	Axis 4 - 6 encoder tacho input connector	3.3.1
2	Axis 6 motor input connector	3.3.2
3	Axis 5 motor input connector	3.3.2
4	Axis 4 motor input connector	3.3.2
5	Power input	3.3.3
6	Axis 3 motor input connector (optional)	3.3.2
7	UCC2 and UCClite communication link connector	3.3.5

Key	Description	Refer to section
8	Axis 2 motor input connector	3.3.2
9	Axis 1 motor input connector	3.3.2
10	Axis 0 motor input connector	3.3.2
11	External emergency stop and reset connector	3.3.7
12	UCC2 and UCClite emergency stop connector	3.3.4
13	Earth stud	3.3.6

3.3 Connections

3.3.1 Encoder card

The encoder interface card is a machine installer configurable option and, if installed, permits the connection of digital encoders to the **SPA2** and **UCC2** or **UCClite** system to provide motor feedback for inclusion into the machines control loop.

For further details on these connections please refer to section 3.5.

3.3.2 Motor connector

These connections are used for the DC motor connector kit placement.

Axis position 3 is for the additional axis interface card that can be fitted by the machine installer to the **SPA2** unit.

For further details on these connections please refer to section 3.4.

3.3.3 Mains connection

The **SPA2** is isolated by disconnecting the IEC mains connector on the rear panel. If any additional means of isolation is required, it must be specified and fitted by the machine manufacturer or the installer of the product.

The **SPA2** is powered from the a.c. mains supply via this IEC 320 connector. The electrical requirements of the unit are as follows:

100 – 240 V ac +10%, -15%

47 – 63 Hz

650 W maximum

The **SPA2** is isolated from AC power by disconnection of the IEC mains connector on the rear panel. If any additional means of isolation is required, it must be specified and fitted by the machine manufacturer or the installer of the product.

The use of a suitable RCD (residual current device), for automatic disconnection in the event of an insulation failure, is recommended. This should be sited within easy reach of the CMM operator and must meet the requirements of IEC61010 and any national wiring regulations in the country of installation.

3.3.4 UCC2 emergency stop connection

This 9-way D-connector links the emergency stop system between either the **SPA2** and the **UCClite** or the **SPA2** and the MCU1 joystick via the **UCC2** controller, the necessary cable for this connection is supplied within the **SPA2** kit.

3.3.5 SPA-A/-B/-C/-D connections

These RJ45 connections permit the dedicated servo system communication link between the **SPA2** and the **UCC2** or **UCClite** controller for an effective control system.

NOTE: Connections A and B are used for a three or four axis **SPA2** system, connections C and D are only used when a six or seven axis system is contained within a single box. Refer to section 6 for further details.

3.3.6 Earth stud

The **SPA2** has an earth stud to permit equipotential bonding of the CMM control system to that of the rest of the CMM.

NOTE: When the **SPA2** is used with the **UCC2** or **UCClite** controller the CMM frame should be bonded to the **SPA2** earth stud and not the **UCC2** or **UCClite** earth stud.

3.3.7 External emergency stop connection

This 9-pin D-type connection is designed to permit connection of external emergency stop devices to the Renishaw controller emergency stop system.

Emergency stop devices must meet the requirements of IEC 60947-5-1 (low-voltage switchgear and controlgear – part 5-1: control circuit devices and switching elements – electromechanical control circuit devices) or UL1054 (standard for special-use switches).

The machine manufacturer or product installer must perform a risk assessment to determine the requirements for emergency stopping and emergency switching off. The **SPA2** emergency stop safety system is designed to achieve category 2 to standard EN954-1:1996 (ISO 13849-1). The risk assessment should therefore have determined that a category 2 safety function is satisfactory.

There are three connection pins available on this connector. Please refer to the table below for their functions:

Pin number	Function
6	ESTOP A
7	ESTOP B
9	RESET B

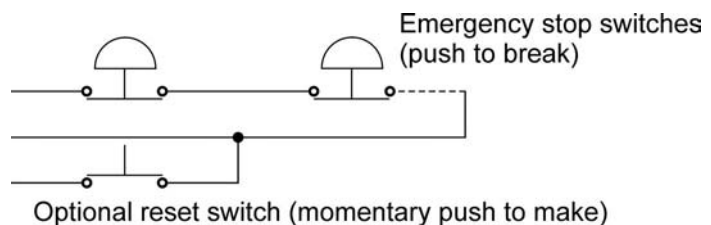

Any additional emergency stop component that is fitted to this connector must have the following electrical characteristics:

Emergency stop system voltage : 24 V

Emergency stop system current : 1 A

NOTE: If the emergency stop reset function is not required then it will be necessary to connect pins 5 and 9 so that when an emergency stop is removed from the system, it will automatically reset.

If no additional emergency stop devices are to be added to a **UCC2** or **UCClite** controller system, connect pins 6 and 7 to permit the MCU1 emergency stop switch to function.

It is strongly recommended that all connections to this connector be fitted by a competent technician or engineer and that all wires should be sleeved. See also 6.4.2.

It should not be necessary to switch off the **SPA2** in an emergency but if a requirement is indicated by the user's risk assessment, emergency switching off for the complete machine must be implemented externally to the **SPA2**.

If indicated by the user's risk assessment, a 'manual reset' button (refer to EN 954-1:1996 para. 5.4) should be included in the emergency stop system. A reset switch is required when there is limited visibility of the danger zone from the control position. The reset switch must be positioned outside the danger zone and in a safe position from which it may be determined that no person is within the danger zone before resetting the safety system.

3.4 Motor connectors

3.4.1 DC motor connection card termination

Each DC motor connection card presents a 7W2 connector for connection of a CMM motor to the **SPA2**, as shown below:

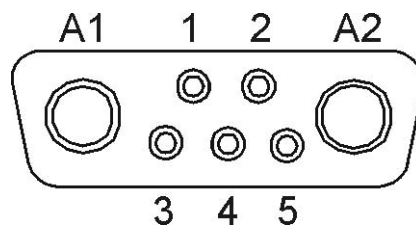

Viewed on face of plug,
or rear of socket

There are seven connections available on this connector. Please refer to the table below:

Connector pin	Function
A1	+ve motor connection (default)
A2	-ve motor connection (default)
1	+ve tacho input (default)
2	-ve tacho input (default)
3	ground reference
4	-ve tacho input (linked to pin 2)
5	ground reference
Shell	Screen

The table shows the default polarity configurations for all pins

NOTE: The motor and tacho polarities on this connector are software configured during the **SPA2** installation process. Please refer to the Renicis user's guide (Renishaw part number H-1000-5058) for details.



WARNING: If the **SPA2** is being integrated on a dual axes DCC driven machine it is essential that the motor polarities on the dual axes are the same.

3.4.2 Additional axis interface card termination

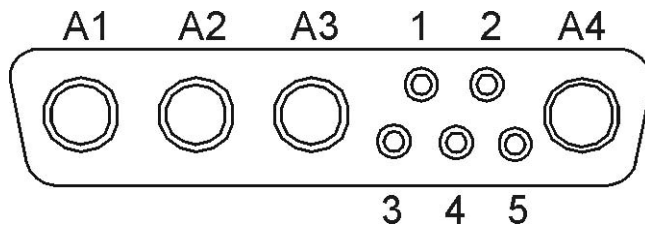

Viewed on face of plug,
or rear of socket

The additional axis interface card presents 1 off 9W4 connector for connection of a CMM motor to the **SPA2**, as shown below:

There are seven connections available on this connector. Please refer to the table below:

Connector pin	Function
A1	+ve motor connection (default)
A2	Reserved for future expansion
A3	-ve motor connection (default)
A4	Reserved for future expansion
1	+ve tacho input (default)
2	-ve tacho input (default)
3	ground reference
4	ground reference
5	ground reference
Shell	Screen

The table shows the default polarity configurations for all pins

NOTE: The motor and tacho polarities on this connector are software configured during the **SPA2** installation process. Please refer to the Renicis user's guide (Renishaw part number H-1000-5058) for details.



WARNING: Pins with the function reserved for future expansion must not be connected to any other system component



WARNING: If the **SPA2** is being integrated on a dual axes DCC driven machine it is essential that the motor polarities on the dual axes are the same.

3.5 Encoder interface card

The encoder interface card offers four axes of encoder input to the **SPA2** system, each being a 15-way high-density D-type connector, designed for digital tacho (encoder) input.

The encoder interface is designed to accept signals from an RS422 compliant encoders.

NOTE: Connection to single ended encoders is not recommended.

The 5 V supply from the encoder interface card has the ability to supply a maximum of 1 A in total.

For connection details please refer to the table below:

Connector pin	Function
1	Not connected
2	0 V (from SPA2)
3	Not connected
4	-Ref mark
5	-B signal
6	-A signal
7	+5 V supply from SPA2
8	Not connected
9	0 V (from SPA2)
10	Not connected
11	Not connected
12	+Ref mark
13	+B signal
14	+A signal
15	0 V (from SPA2)
Shell	Screen

4 Hardware configuration of the SPA2



CAUTION: Connection to the protective bonding circuit: Provision for connecting the complete machine to the protective ground (earthing) is the responsibility of the manufacturer or equipment installer.

Isolation: The **SPA2** is isolated by removing the mains connector. It is the responsibility of the equipment installer or user to fit additional means of isolation if indicated by risk assessment.

Earth fault/residual current protection: It is the responsibility of the machine manufacturer or product installer to ensure an adequate level of protection for the complete machine installation.

4.1 Fitting a motor connection card

When the **SPA2** kit is ordered, the appropriate quantity and type of motor connector cards for that kit will be supplied with the **SPA2**. The following section details the installation procedure for these cards.

4.1.1 Recommended procedure to install the motor connection cards

NOTE: It is assumed that this is the first installation process and that no mains supply is connected to the unit.

1. Remove the **SPA2** from its transit packaging.
 2. Place the **SPA2** on a firm flat surface, with the front of the unit placed on the surface and the rear of the unit in the upward direction.
 3. Remove only the necessary connector protection covers from the rear of the **SPA2**, this is achieved by removing the two holding screws and washers from the appropriate protection cover. Retain the fixings.
 4. Remove a motor connection card from its packaging.
 5. Align the motor connection card with the necessary axis connection position on the rear of the **SPA2** and press the connector firmly into position (see following diagram).
-



CAUTION: It is essential that each axis connector location should have either a connector blanking plate or a motor connector in place before the SPA is powered up.

NOTE: The motor connection card must be inserted into the **SPA2** until its mounting plate is in contact with the rear panel of the **SPA2**.

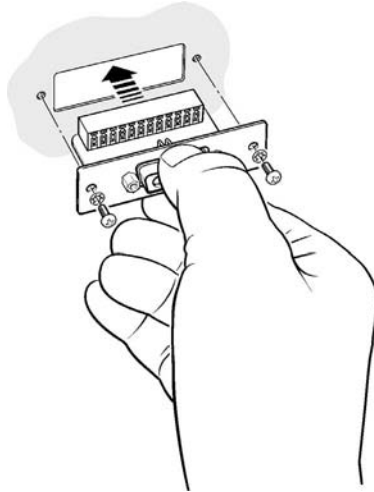

6. Using the screws and washers removed in step 3, fix the motor connection card to the **SPA2** rear panel.
7. Repeat steps 3 through 6 until all required motor connections are fitted to the **SPA2**.
8. If an encoder interface card is to be fitted please proceed to section 4.2, if a 4th axis interface card is to be fitted please proceed to section 4.3, otherwise the unit can now be installed.

4.2 Installing the encoder option card



CAUTIONS: Connection to the protective bonding circuit: Provision for connecting the complete machine to the protective ground (earthing) is the responsibility of the manufacturer or equipment installer.

Isolation: The **SPA2** is isolated by removing the mains connector. It is the responsibility of the equipment installer or user to fit additional means of isolation if indicated by risk assessment.

Earth fault/residual current protection: It is the responsibility of the machine manufacturer or product installer to ensure an adequate level of protection for the complete machine installation.

NOTE: It is assumed that this procedure is part of the initial installation process and no mains connection is made to the **SPA2**.

4.2.1 Recommended procedure to install the encoder interface card

1. Remove the encoder interface card from its packaging.
2. Attach the connection cable that is supplied with the encoder interface card to the card, see diagram below.

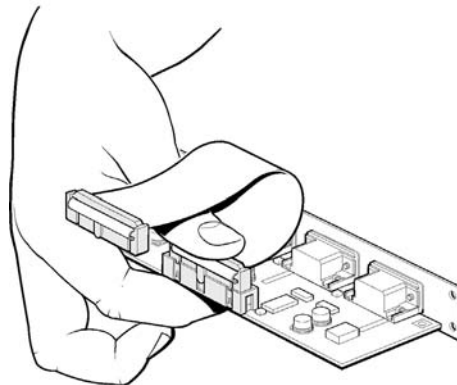

3. Place the **SPA2** on a firm flat surface, with the base of the unit placed on the surface and the rear of the unit facing towards you.
4. Remove the appropriate encoder interface connector protection cover from the rear of the **SPA2**, refer to section 3.1 or 3.2. This is achieved by removing the six holding screws and washers from the edges of the protection cover. Retain the fixings.
5. Remove the top panel of the **SPA2** enclosure by removing the five lid screws and washers at the top of the rear panel and the three screws located at the top of each side panel. Retain the fixings.

6. Position the encoder interface card into the location as shown in diagram below, and fix the option card to the rear of the **SPA2** using the fixings removed in step 4.

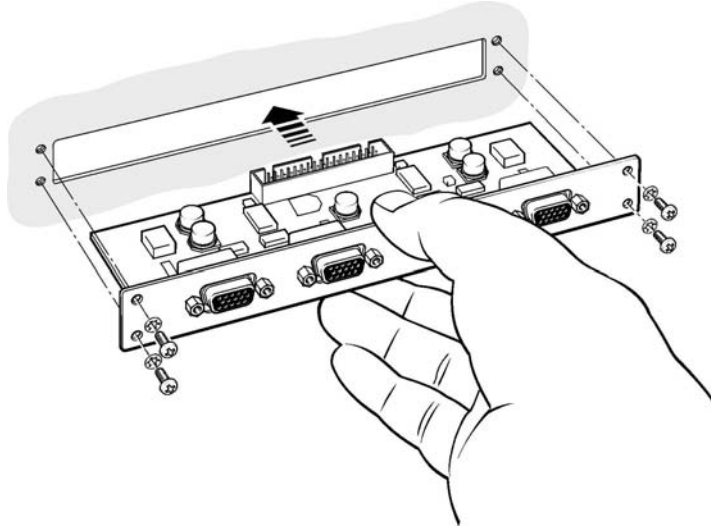

7. Fit the connection cable attached to the encoder interface card, to the **SPA2** control electronics.

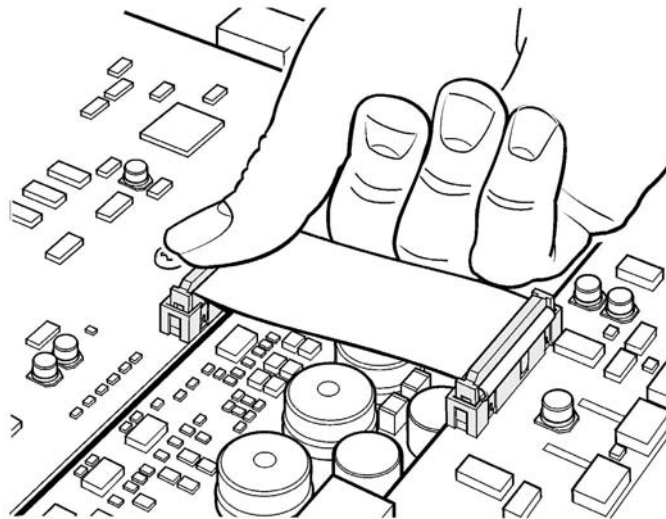

NOTE: Caution is advised when fitting the connection cable from the encoder interface card to the **SPA2** control electronics. It is recommended that the cable is inserted with minimal force using a finger below the PCB to support the connector insert.

8. If a 4th axis interface card is to be fitted please proceed to section 4.3, otherwise proceed to step 9.
9. Refit the top panel of the **SPA2** and secure using the fixings removed in step 5.

4.3 Fitting the 4th axis option card



CAUTION: Connection to the protective bonding circuit: Provision for connecting the complete machine to the protective ground (earthing) is the responsibility of the manufacturer or equipment installer.

Isolation: The **SPA2** is isolated by removing the mains connector. It is the responsibility of the equipment installer or user to fit additional means of isolation if indicated by risk assessment.

Earth fault/residual current protection: It is the responsibility of the machine manufacturer or product installer to ensure an adequate level of protection for the complete machine installation.

If the 4th axis interface card has been purchased with the **SPA2** the recommended procedure for installation of this card follows.

4.3.1 Recommended procedure to install the 4th axis interface card

1. Remove the 4th axis option card from its packaging.
2. Attach the communication connection cable that is supplied with the 4th axis option card to the card, see diagram below.

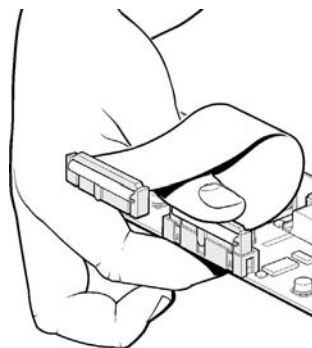

3. If the 4th axis interface card is being installed after the encoder interface card has been installed please proceed to step 6, otherwise continue with step 4
4. Place the **SPA2** on a firm flat surface, with the base of the unit placed on the surface and the rear of the unit facing towards you.
5. Remove the top panel of the **SPA2** enclosure by removing the five lid screws at the top of the rear panel and the screw located at the top of each side panel, near the front. Retain the fixings.
6. Remove the necessary connector protection cover from the rear of the **SPA2**, this is achieved by removing the two holding screws from the edges of the protection cover. Retaining the fixings.

7. Included in the 4th axis interface card kit there are three 15 mm long PCB pillar mounts. These must be attached to the three studs that are located to the left hand side of the enclosure and tightened to ensure good earth continuity.

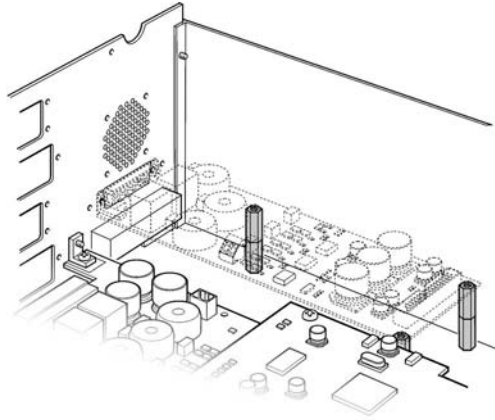

8. Position the 4th axis interface card into the location, as shown in diagram below.

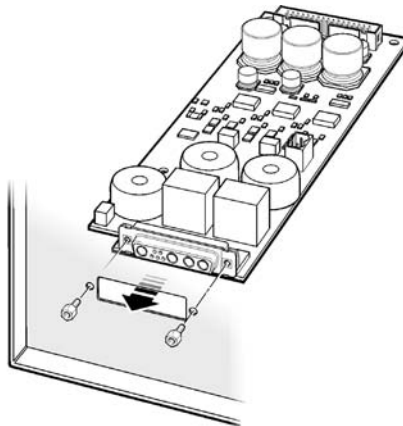

9. Locate the 4th axis interface card onto the PCB pillar mounts using the M4 screws supplied with the kit. Do not tighten these screws.
10. Using the pillars and washers supplied in the kit, locate the 4th axis interface connector through the location hole in the rear panel of the **SPA2**. Tighten these pillars and then tighten the screws inserted in step 9.

11. Fit the connection cable attached to the 4th axis interface card to the **SPA2** motherboard control electronics. This connection is located at the rear left hand corner of the motherboard.

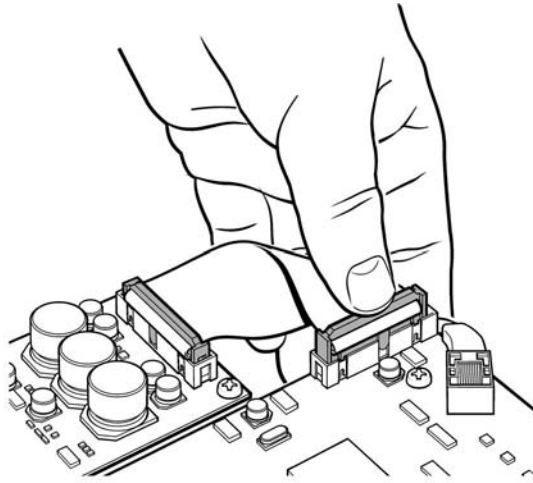

NOTE: Caution is advised when fitting the connection cable from the 4th axis interface card to the **SPA2** control electronics. It is recommended that the cable is inserted with minimal force using a finger below the PCB to support the connector insert.

12. Fit the voltage supply cable loom from the 4th axis option card to the **SPA2** control electronics, as shown in diagram below.

NOTE: Caution is advised when fitting the connection cable from the encoder option card to the **SPA2** control electronics. It is recommended that the cable is inserted with minimal force.

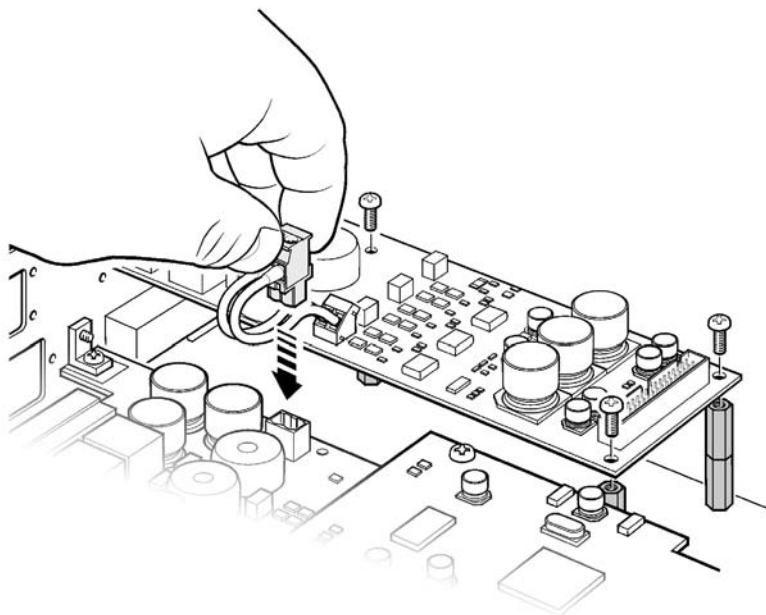

13. Refit the top panel of the **SPA2** enclosure by reversal of the method used in step 4 - 6.

4.4 Mounting the SPA2

The **SPA2** can be installed into either a 19" rack mount system or as a stand alone unit.

The dimensions of the units are:

Width: 440 mm

Height: 135 mm

Depth: 330 mm

4.4.1 Stand alone mounting

Four self-adhesive rubber feet are supplied with the unit for stand-alone use.

4.4.2 Mounting in a 19" rack

To permit the **SPA2** to be fitted into a 19" enclosure, a 3U rack mounting kit (A-1333-0029) is required.

NOTE: The screws supplied with this kit are M5 × 6 mm countersink type. DO NOT replace with longer screws as damage could occur.

The following procedure is recommended to fit the rack mounting brackets to the **SPA2**:

1. Position the **SPA2** on a firm flat surface, with either the left or right hand side of the unit placed on the surface and the front of the unit facing towards you.
2. Remove the blanking plugs from the side of the unit, there are two of these located about 15mm from the front lip on the enclosure and about 15 mm from the top and bottom of the enclosure.
3. Remove the 3U rack mounting kit from its packaging and place one of the countersunk screws supplied in the kit through one of the rack mounting brackets supplied.
4. Align this screw and mounting bracket assembly to the fixing holes in the side of the **SPA2** enclosure and engage the screw into the mating thread. Do not tighten at this point
5. Align the other fixing location in the rack mounting bracket with the fixing hole in the side of the **SPA2**, and engage the other countersunk screw into the mating thread.
6. Tighten both countersunk screws to ensure a secure fixing.
7. Rotate the **SPA2** such that the other side of the enclosure can be accessed and then repeat steps 2 to 6.

5 System installation

5.1 General

The **SPA2** system is configured by software settings stored within the unit and on the host PC. The setting of these configuration parameters is performed by the Renicis commissioning software via the **UCC2** or **UCClite** communication protocol.

The Renicis software contains a structured installation process to assist in the commissioning of the **SPA2**, please refer to the Renicis installation guide (Renishaw part number H-1000-5058) for further information.

5.2 Testing and verification

The manufacturer of the finished machine, or the installer of the **SPA2**, is responsible for ensuring that the following test and verification procedures are performed to the appropriate standards on the complete installation:

- Verification that the electrical equipment is in compliance with the technical documentation
- Continuity of the protective bonding circuit
- Insulation resistance tests
- Voltage tests
- Protection against residual voltages
- Functional tests, particularly those related to safety

6 Interconnection schemes

6.1 UCC2 DC motor and tacho connection

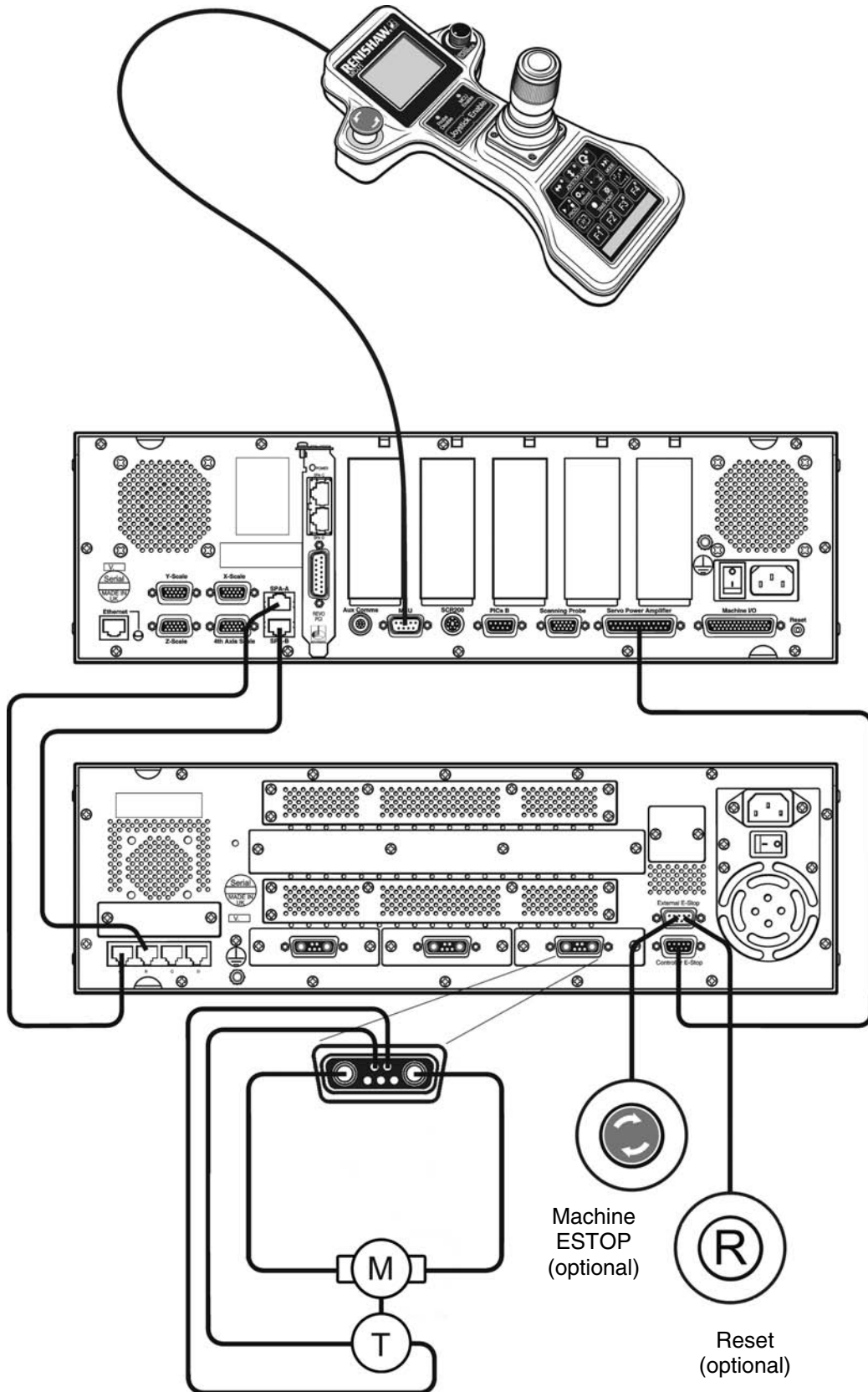

6.2 UCCLite DC motor and tacho connection

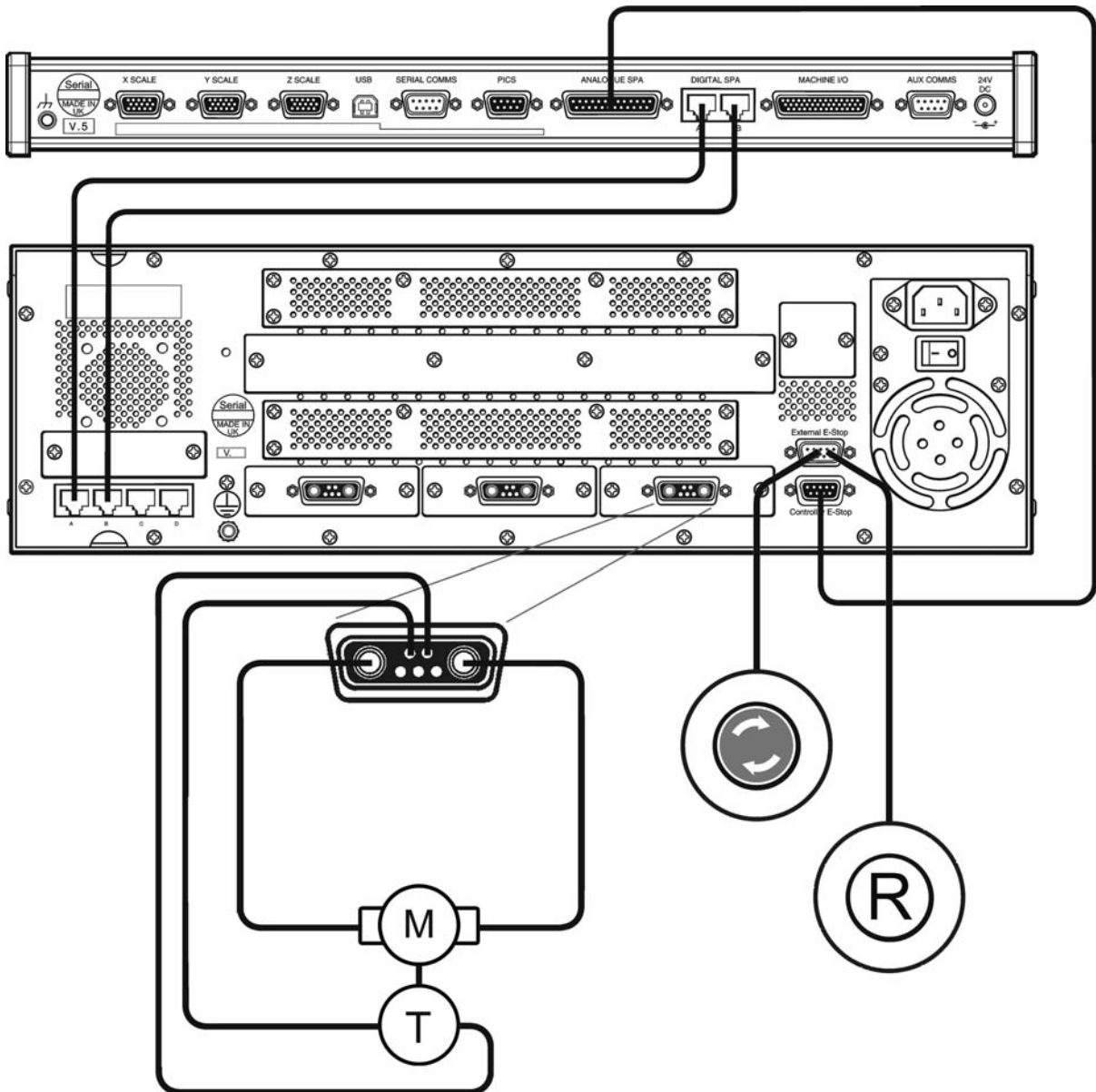

6.3 Dual SPA2 DC motor and tacho configuration

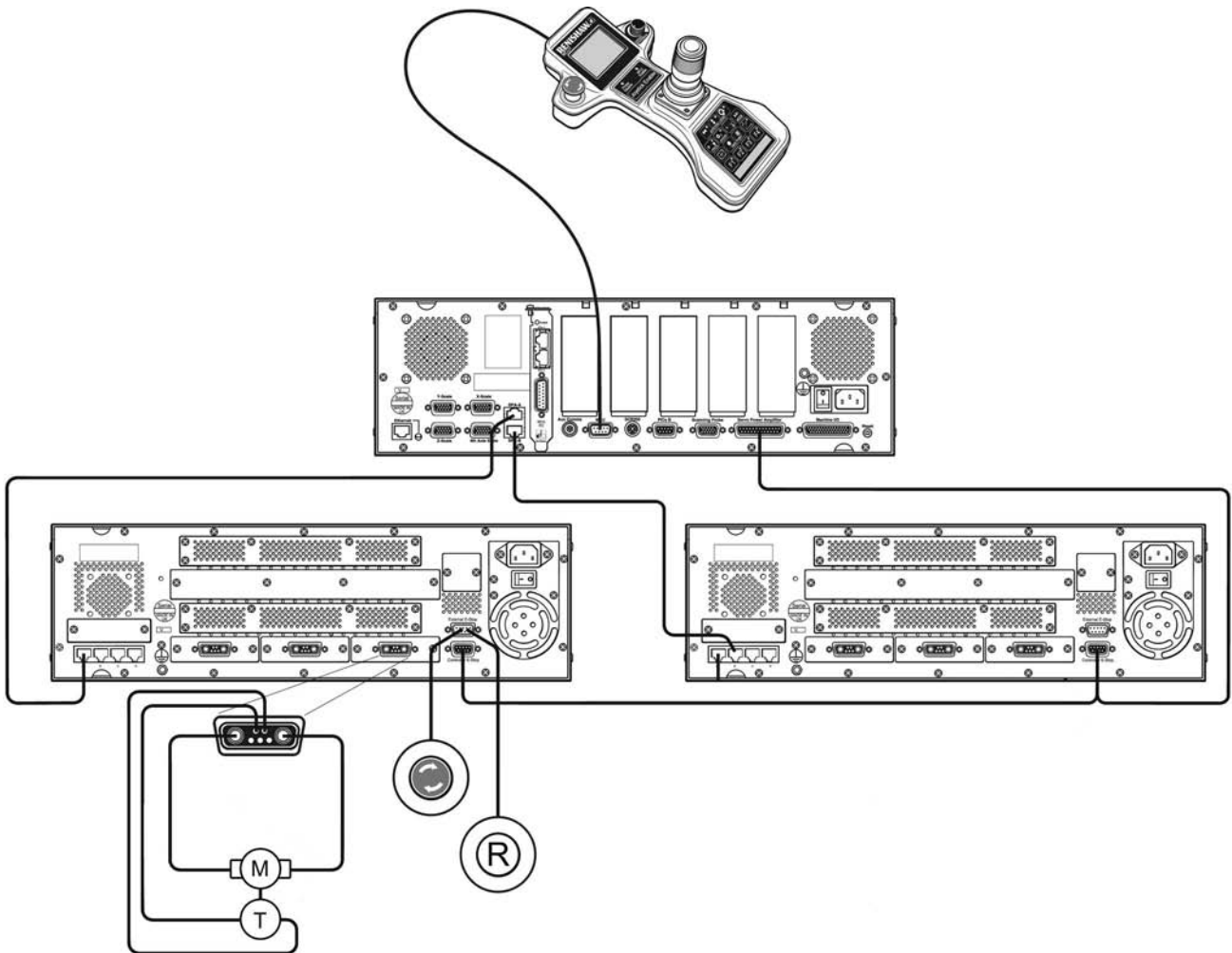

6.4 Preparation of integration kits

When the **SPA2** integration kit is received it will contain the necessary components required connect the **SPA2** and either the **UCC2** or **UCC/ite** controller system to a CMM installation.

NOTE: All connectors used in the integration of the **SPA2** to a CMM installation are widely commercially available, the connector kits are designed to ease the system integration by permitting the connectors to be purchased at the same time as the **SPA2**.

6.4.1 Motor connectors

Each connector kit will contain three motor connectors which are appropriate for DC motor output from the **SPA2**.

NOTE: This connector is of the solder bucket variety, it is recommended that it is fitted to the CMM wiring by a competent technician or engineer, and that sleeving is used for all connections to reduce the possibility of short circuits.

Each of the three connector assemblies consist of the following:

- 1 off metal backshell
- 1 off 7W2 power and signal D-type connector
- 2 off power pins

6.4.2 Emergency stop and reset switch

The **SPA2** and **UCC2** or **UCC*lite*** control system is capable of providing category 2 * emergency stop system safety level. However, this is subject to the machine manufacturers / installers method of integration and their risk assessment.

Each machine integration kit contains one 9-way D-type connector which permits the installer to add additional emergency stop devices to the emergency stop system integrated within the **SPA2**.

NOTE: Emergency stop switches (where required by the manufacturer or installer's risk assessment) must comply with the requirements of standards UL1054/EN60947.

This connector is of the solder bucket variety, it is recommended that they are fitted to the CMM wiring by a competent technician or engineer, and that sleeving is used for all connections to reduce the possibility of unintentional short circuits.

* Category 2 to EN954-1:1996 (ISO13849-1:1999).

7 Revision history

Issue 01-A

First issue.

Issue 02-A

Document updated to include an additional safety statement (see page 22 section 4.1.1).

Issue 03-A

Inclusion of **UCC***lite* product.

Renishaw plc
New Mills, Wotton-under-Edge,
Gloucestershire, GL12 8JR
United Kingdom

T +44 (0)1453 524524
F +44 (0)1453 524901
E uk@renishaw.com
www.renishaw.com

RENISHAW 
apply innovation™

**For worldwide contact details,
please visit our main website at
www.renishaw.com/contact**



H - 1000 - 5234 - 03