

# ATOM™ miniature encoder system

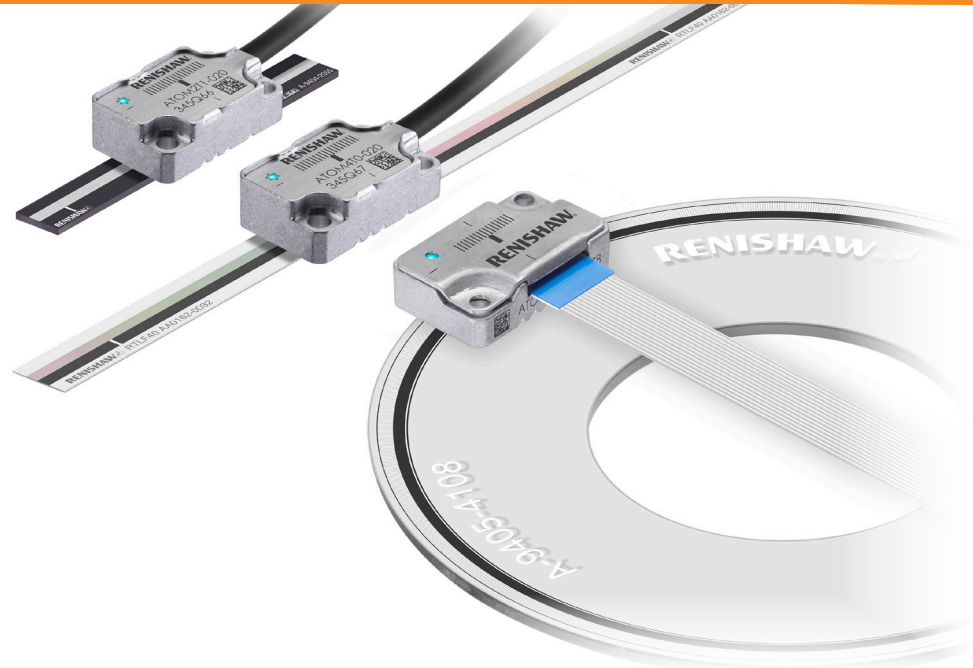

**ATOM™ is the world's first miniature encoder with filtering optics, providing improvements in dirt immunity, signal stability and reliability for linear, partial arc and rotary applications.**

**ATOM features a number of other advances that help maintain signal stability, including integral Auto Gain Control and Auto Offset Control, along with a highly reliable IRED light source, making the product suitable for use in applications demanding quality and dependability.**

The miniature readhead is available in 2 formats: hi-flex cable output or flexible-printed circuit (FPC) output. The FPC version helps reduce overall package size, with a reduced Z-height and easy cable routing.

ATOM is available with a range of high-accuracy optical linear, partial arc and rotary scales, including conventional glass spars, 'unbreakable' stainless steel tape scales and glass discs. Installation has been simplified by an intuitive set-up LED on the readhead that indicates signal level. Optical reference mark phasing and incremental signal optimisation can be achieved with the simple press of a button.

ATOM is suitable for use in a variety of applications that require compact size, including laser scanners, CMM arms, semiconductor manufacturing, compact linear motors/motion stages, small DDR torque motors, galvanometers and microscope stages.

ATOM – miniaturisation without compromise.

- **Miniature package: 8.35 mm × 12.7 mm × 20.5 mm (7.3 mm × 12.7 mm × 20.5 mm for FPC version)**
- **Highest signal stability and dirt immunity in its class due to filtering optics**
- **Long-term stability provided by integral Auto Gain Control (AGC) and Auto Offset Control (AOC)**
- **Low sub-divisional error (SDE) and jitter**
- **Easy installation and diagnostics using the set-up LED on the readhead**
- **Auto-phase bi-directional optical reference mark**
- **Available in 20 µm and 40 µm scale pitch versions**
- **Analogue output direct from the readhead**
- **Multiple interpolation options, with resolutions to 1 nm**
- **Range of high accuracy rotary, partial arc and linear scales**
- **Optional ADTpro-100 Advanced Diagnostic Tool to optimise set-up and assist with system diagnostics**

## System features

### High performance

- **Need higher speed?**

ATOM is the fastest encoder in its class, with maximum speeds up to 20 m/s and a range of high-speed interpolation options for digital versions.

- **Need higher accuracy?**

ATOM offers linear tape scales with specified overall accuracy to  $\pm 5 \mu\text{m/m}$  at 20 °C, without the need for 2-point compensation that competitor encoders require.

- **Need improved positional stability and repeatability?**

ATOM has low noise (jitter), allowing users to increase servo-loop gain without instability, whilst reaping other dynamic performance benefits such as faster settling times and higher acceleration.

- **Need smoother velocity control?**

Reduce velocity ripple, improve scanning performance, reduce blur on vision systems and image capturing – all thanks to ATOM's superior optical scheme and integral AOC.

### Lissajous stability

ATOM features a miniaturized version of Renishaw's unique filtering optics that are used in the TONiC™ encoder range. This optical scheme is tuned to a specific spatial frequency, so it rejects other harmonics, including those caused by dirt or other contaminants. The result is a Lissajous with high purity, that retains its fidelity even when the scale is exposed to contamination: ideal for applications where reliability is critical.

### Optional Advanced Diagnostic Tool ADTpro-100

The ATOM encoder system is compatible with Renishaw's ADTpro-100 diagnostic tool.

The ADTpro-100 is a handheld, standalone encoder diagnostic tool featuring an integral colour touch screen. It assists in system set-up and planned maintenance to help minimise unscheduled machine downtime. The ADTpro-100:

- Requires no computer or additional set-up equipment to display comprehensive real-time encoder information.
- Is easy and intuitive to use with plug-and-play functionality to aid system set-up and calibration.
- Interfaces with the optional ADT View computer software. ADT View can be used to update the ADTpro-100 firmware.



The ADTpro-100 is ideal for aiding system optimisation and diagnostics, particularly for installations when the readhead LED is not visible. It can be used standalone or in-line, connected between the readhead and the controller as part of the control loop.

More information on the ADTpro can be found in the ADTpro-100 Advanced Diagnostic Tool data sheet.

## Compatible scales

- **Stainless-steel tape scale (RKLF):**

Self-adhesive mounted stainless steel tape scales that can be wrapped around drums, arcs or shafts with radii down to 26 mm.

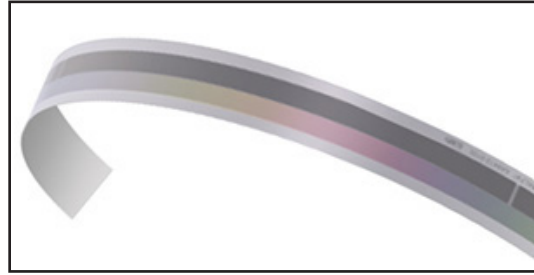

- **Stainless-steel tape scale (RTLFL):**

High-accuracy scales with graduations directly marked onto the steel tape surface. Available on reels for cut-to-length convenience.

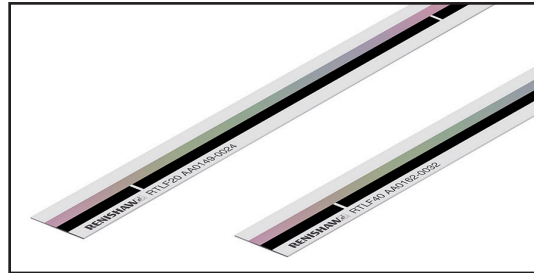

- **Glass linear spars (RCLC):**

Conventional glass spars, available in lengths up to 130 mm.



- **Glass discs (RCDM):**

High-accuracy rotary scales with outer diameters down to 17 mm.



## ATOM readhead and interface options

### 20 µm and 40 µm readheads with high-flex cable:

For general purpose applications. Superior quality cable tested to 20 million flex cycles.

- Terminated with a 15-way D-type connector for high-volume users requiring analogue outputs.

---

**NOTE:** A CAL button is not included on this option. Refer to the installation guide for details on how to calibrate.

---

- Terminated with a T-type interboard connector for use with ACi/Ri/Ti interfaces.

### 20 µm and 40 µm readheads with FPC cable:

Side exit FPC cable allows the smallest overall package size.

- For use with ACi interface or direct connection to user electronics.



**ACi** interfaces are a range of high performance, miniature, open interpolator subsystems. They bring unparalleled price-performance benefits to today's motion systems that need fine resolution coupled to high speed performance in an ultra compact, open format, small footprint solution and have provision for calibrating the system. Digital interpolation down to 10 nm at up to 40 MHz clocked output is available. FPC or cable input versions available.

---

**NOTE:** ACi interfaces are not compatible with the ADTpro-100 diagnostics tool.

---

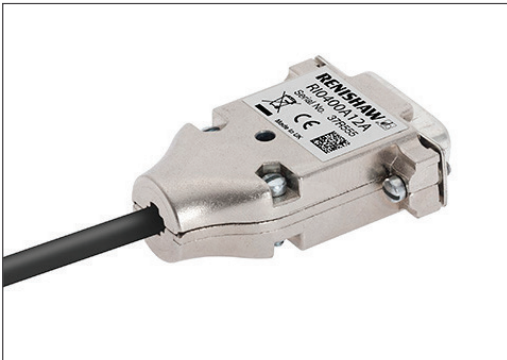

**Ri** interfaces are contained within an industry standard 15-way D-type connector shell, including CAL button. They offer digital interpolation down to 50 nm (clocked) and 0.5 µm (non-clocked). Analogue variants are also available.

---

**NOTE:** Ri digital interfaces are not compatible with the ADTpro-100 diagnostics tool.

---



**Ti** interfaces are designed for applications that require higher speed, lower SDE, digital interpolation down to 1 nm resolution and include a CAL button. Clocked outputs have been optimised for speed and performance at all resolutions for industry-standard controllers. Analogue variants are also available.

# ATOM readhead dimensions

Dimensions and tolerances in mm

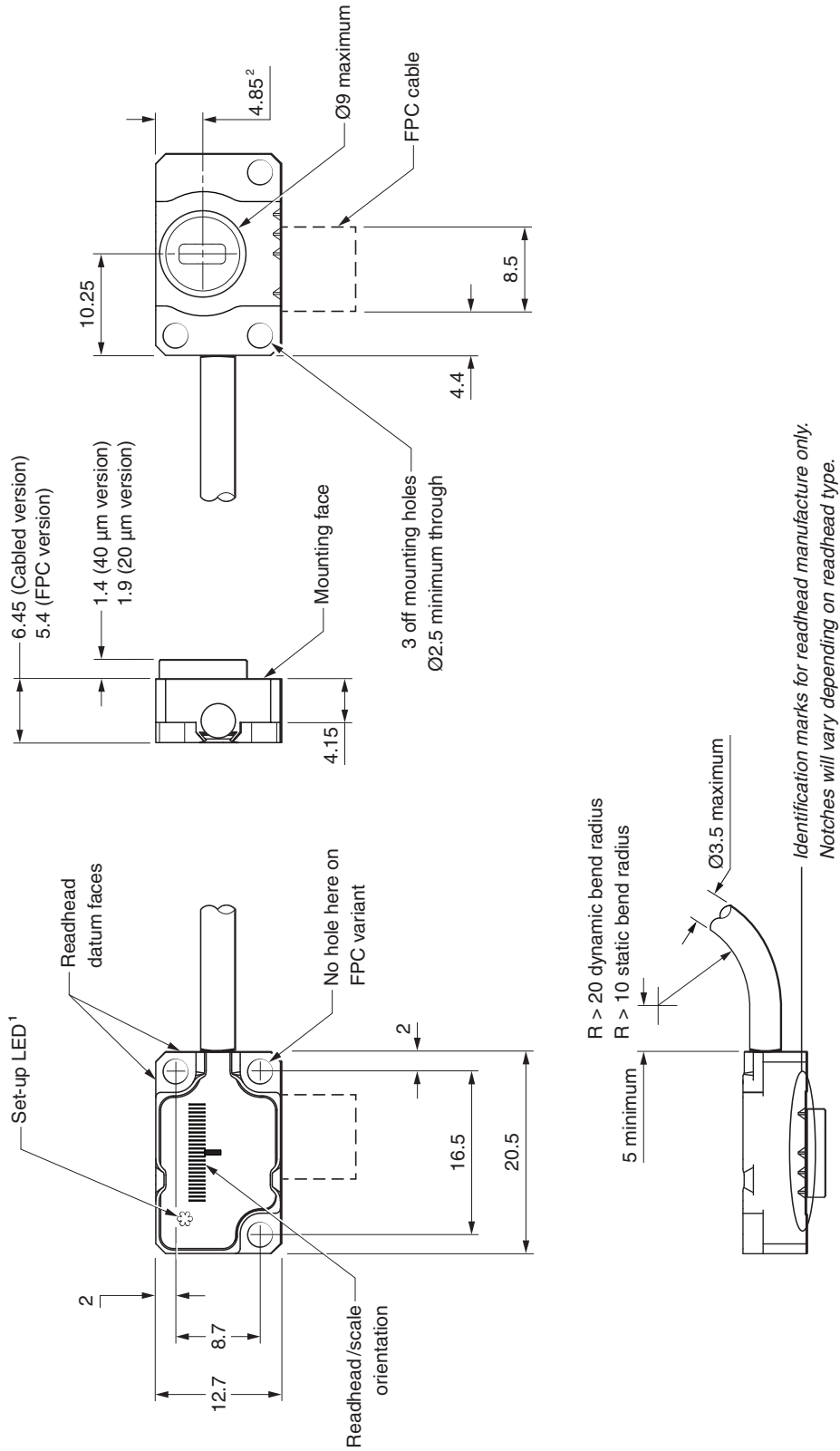

<sup>1</sup> On FPC variants the set-up LED cut-out is circular.

<sup>2</sup> Not optical centreline.

## Readhead output signals

Function	Signal	Colour	JST <sup>2</sup>	Interboard	FPC	15-way D-type		
			(on interboard)	connector (T)	(F)	15-way D-type (D)		
			Pin	Pin	Pin	Pin		
Power <sup>1</sup>	5 V	Brown	11	4	9, 10	4, 5		
	0 V	White	5	13	3, 6, 11, 14	12, 13		
Incremental	Cosine	V <sub>1</sub>	+	Red	4	9	5	
			-	Blue	3	5	4	1
	Sine	V <sub>2</sub>	+	Yellow	7	12	2	10
			-	Green	6	14	1	2
Reference mark	V <sub>0</sub>	+	Violet	10	2	13	3	
		-	Grey	9	8	12	11	
Set-up	V <sub>x</sub>	Clear	12	6	16	6		
Remote CAL	CAL	Orange	8	10	15	14		
Shield	-	Screen	Cable ferrule	Cable ferrule	Readhead body	Case		
Do not connect	-	-	1, 2	1, 3, 7, 11	7, 8	7, 8, 15		

## ATOM terminations

JST connector

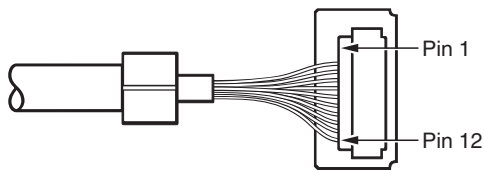

Interboard connector

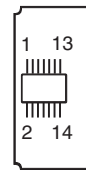

FPC connections

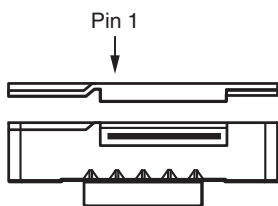

15-way D-type plug

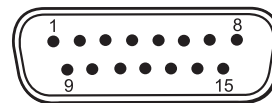

## Maximum speed

40 µm readhead - 20 m/s (-3dB)

20 µm readhead - 10 m/s (-3dB)

<sup>1</sup> All power connections can be used either to minimise voltage drop down the cable or incorporate voltage sensing.

<sup>2</sup> Only available on interboard connector.

# RKLF tape scale installation drawing

Dimensions and tolerances in mm

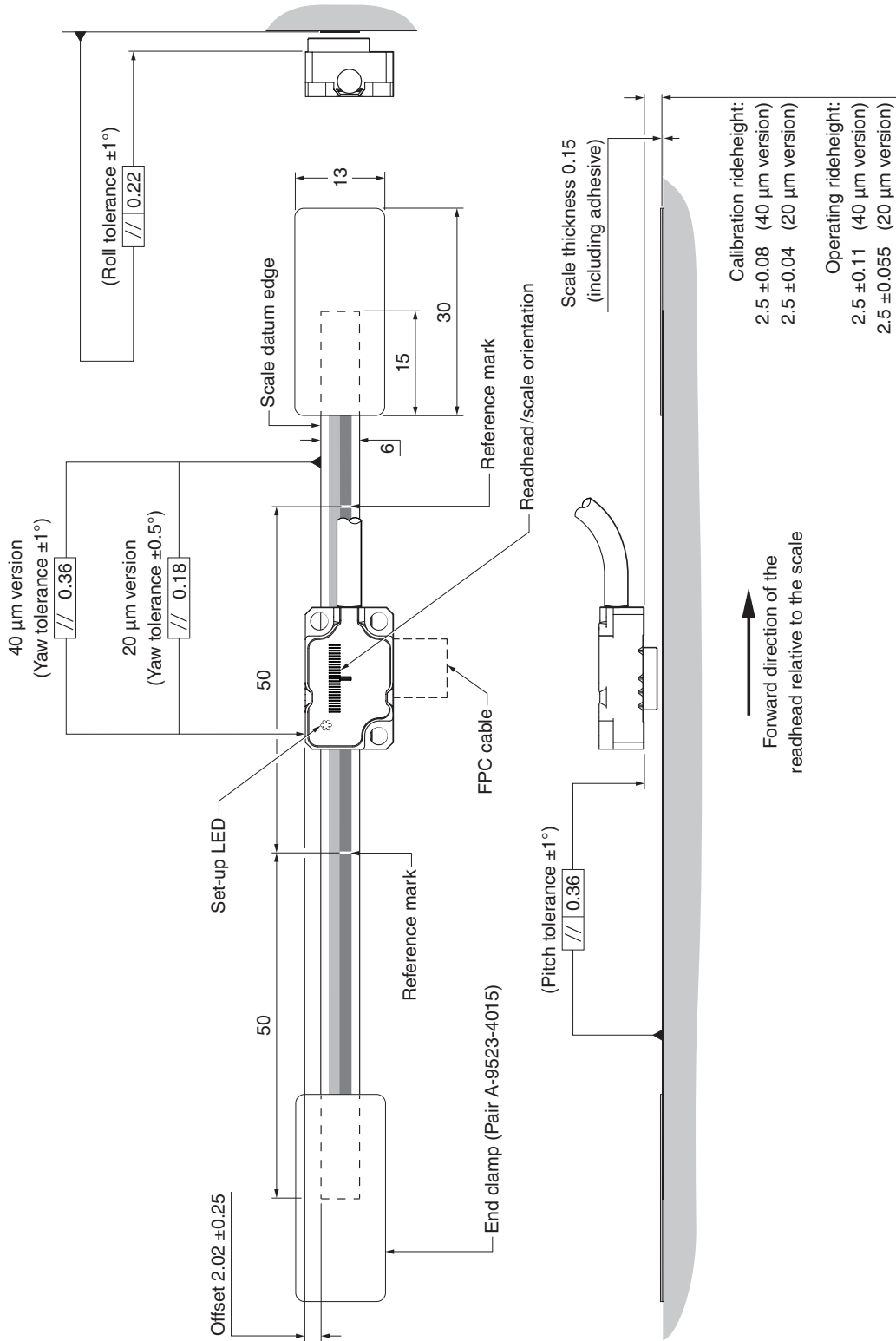

For detailed installation drawings refer to [www.renishaw.com/atomdownloads](http://www.renishaw.com/atomdownloads).  
For further information on the use of RKLF scale for partial arc applications refer to the *RKL partial arc scale data sheet* (Renishaw part no. L-9517-9897).

## RKLF tape scale technical specifications

<b>Material</b>		Hardened and tempered martensitic stainless steel fitted with a self-adhesive backing tape
<b>Form (height x width)</b>		0.15 mm x 6 mm (including adhesive)
<b>Scale pitch <sup>1</sup></b>		20 µm and 40 µm
<b>Reference mark</b>		Auto-phase optical reference mark repeatable to unit of resolution throughout specified speed and temperature range Customer de-selectable reference marks at 50 mm spacing <sup>2</sup> Reference mark in the centre of scale for lengths < 100 mm
<b>Accuracy (at 20 °C)</b>	RKLF20-S/RKLF40H-S RKLF40-S	±5 µm/m ±15 µm/m
<b>Linearity (at 20 °C)</b>	RKLF20-S/RKLF40H-S RKLF40-S	±2.5 µm/m achievable with two-point error correction ±3 µm/m achievable with two-point error correction
<b>Installation temperature <sup>3</sup></b>		+10 °C to +35 °C
<b>Coefficient of thermal expansion (at 20 °C)</b>		Matches that of substrate material when scale ends fixed by epoxy mounted end clamp
<b>Length <sup>4</sup></b>		20 mm to 1 m in 10 mm increments 1 m to 10 m in 1 m increments Overall length = measuring length + 70 mm Scale length = measuring length + 40 mm
<b>Mass</b>		4.6 g/m
<b>End fixing</b>		Epoxy mounted end clamps (A-9523-4015) Approved epoxy adhesive (A-9531-0342) Scale end movement typically < 1 µm <sup>5</sup>

<sup>1</sup> 20 µm RKLF scale is not suitable for partial arc applications.

<sup>2</sup> Only the selected reference mark is bi-directionally repeatable.

<sup>3</sup> Ensure that the scale and end clamps are installed following the installation process described in the *ATOM linear encoder systems* installation guide (Renishaw part no. M-9693-9723).

<sup>4</sup> The maximum recommended axis length is 1 m for 20 µm RKLF systems.

<sup>5</sup> To limit the maximum tension in the scale  $(CTE_{\text{substrate}} - CTE_{\text{scale}}) \times (T_{\text{use extreme}} - T_{\text{install}}) \leq 550 \mu\text{m/m}$  where  $CTE_{\text{scale}} = \sim 10.1 \mu\text{m/m}^\circ\text{C}$ .



# RTLFL tape scale installation drawing

Dimensions and tolerances in mm

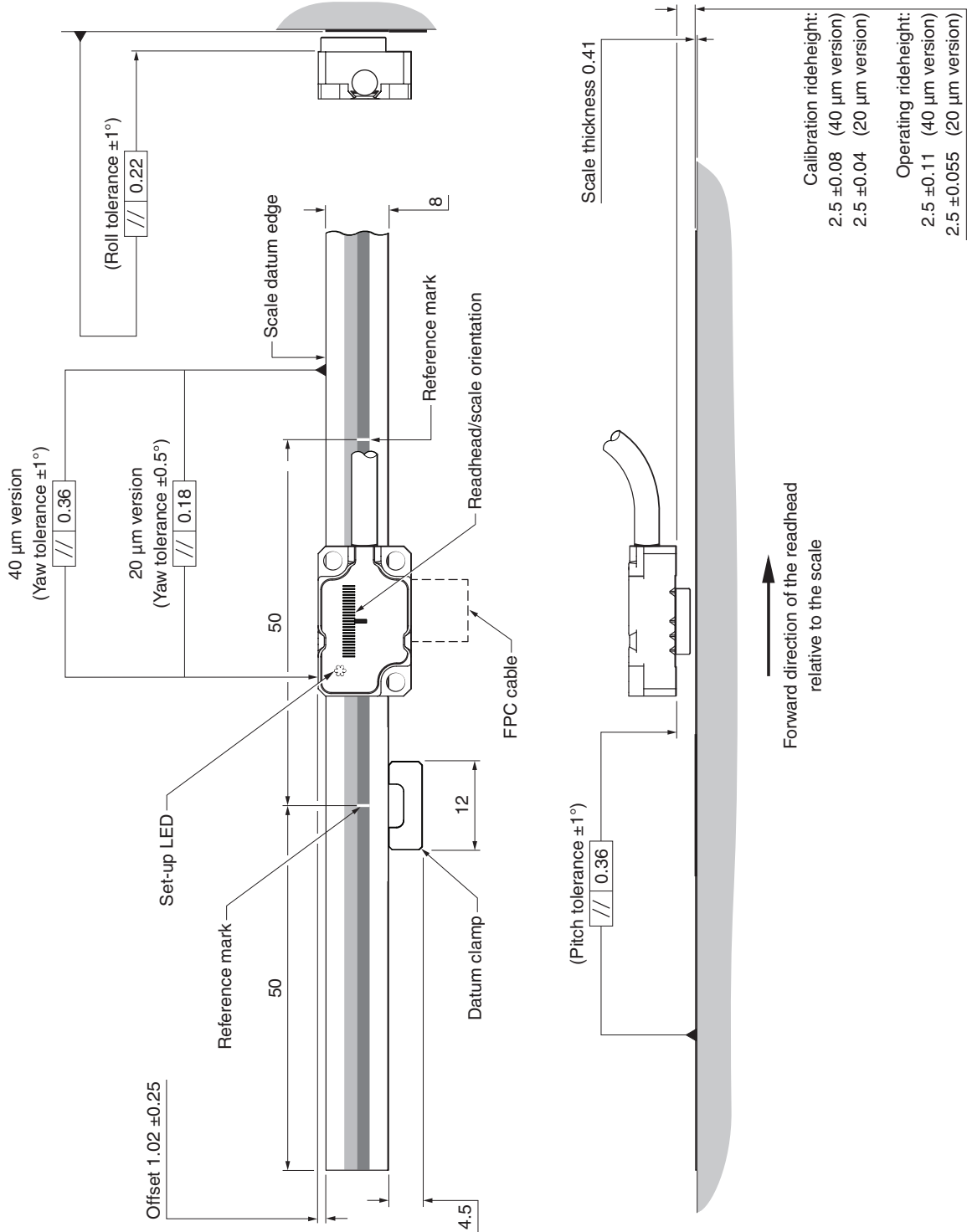

For detailed installation drawings refer to [www.renishaw.com/atomdownloads](http://www.renishaw.com/atomdownloads).

## RTLIF tape scale technical specifications

<b>Material</b>	Hardened and tempered martensitic stainless steel fitted with a self-adhesive backing tape
<b>Form (height x width)</b>	0.41 mm x 8 mm (including adhesive)
<b>Scale pitch</b>	20 µm and 40 µm
<b>Datum fixing</b>	Adhesive datum clamp A-9585-0028 secured with Loctite® 435
<b>Reference mark</b>	Auto-phase optical reference mark repeatable to unit of resolution throughout specified speed and temperature range Customer deselectable reference marks at 50 mm spacing <sup>1</sup> Reference mark in the centre of scale for lengths < 100 mm
<b>Accuracy (at 20 °C)</b>	RTLIF20-S/RTLIF40H-S ±5 µm/m RTLIF40-S ±15 µm/m
<b>Coefficient of thermal expansion (at 20 °C) <sup>2</sup></b>	10.1 ±0.2 µm/m/°C
<b>Length <sup>3</sup></b>	20 mm to 1 m in 10 mm increments 1 m to 10 m in 1 m increments Scale length = measuring length + 6 mm (without optional end covers)
<b>Mass</b>	12.2 g/m

<sup>1</sup> Only the selected reference mark is bi-directionally repeatable.

<sup>2</sup> The substrate coefficient of thermal expansion does not need to match that of the scale.

<sup>3</sup> The maximum recommended axis length is 1 m for 20 µm RTLIF systems.

# RCLC glass spar installation drawing

Dimensions and tolerances in mm

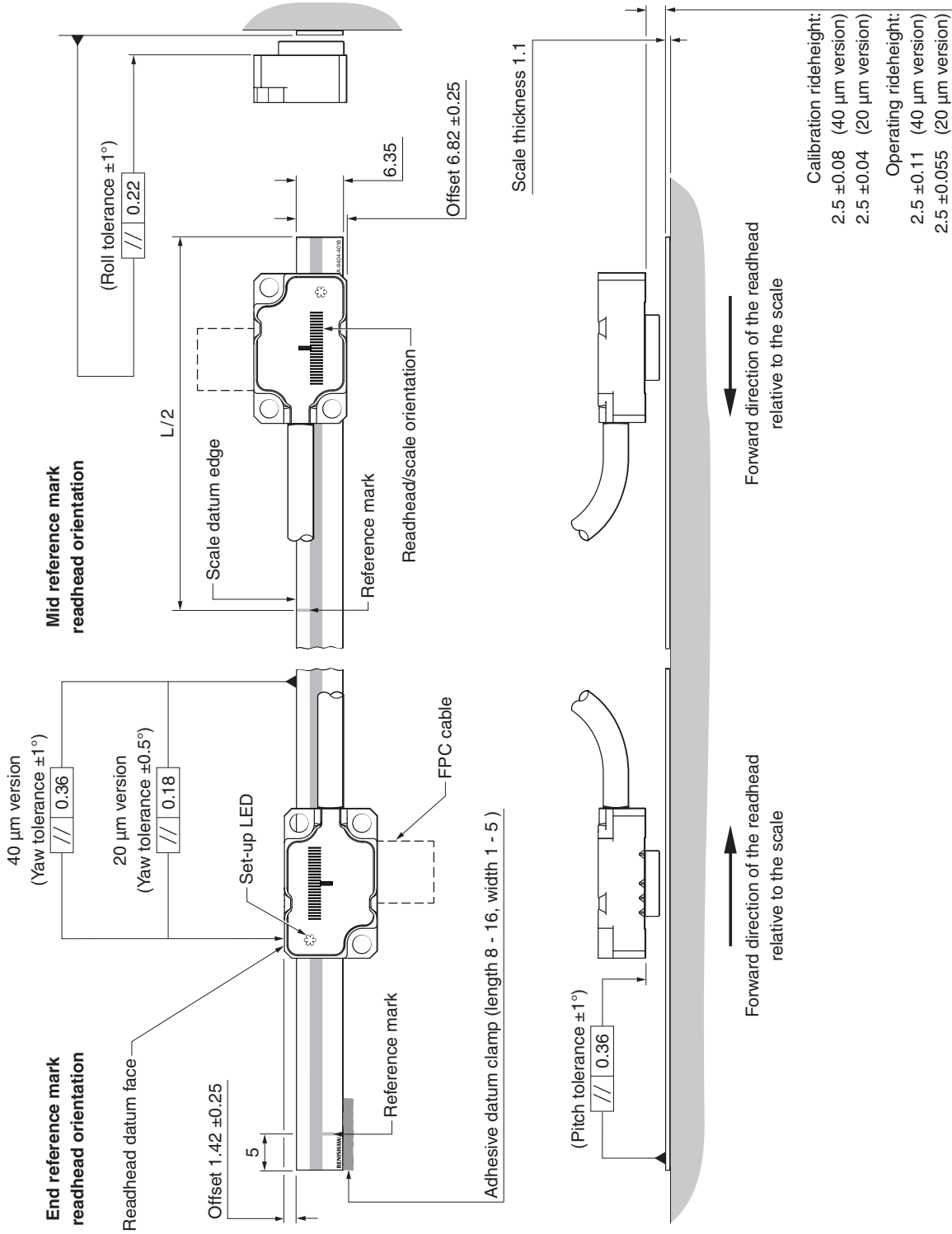

## RCLC glass spar technical specifications

<b>Material</b>	Soda-lime glass fitted with a self-adhesive backing tape
<b>Form (height x width)</b>	1.1 mm x 6.35 mm (including adhesive)
<b>Pitch</b>	20 µm and 40 µm
<b>Datum fixing</b>	Fillet of adhesive (A-9531-0342) on one side of the scale
<b>Reference mark</b>	Auto-phase optical reference mark repeatable to unit of resolution throughout specified speed and temperature range Either mid or one end of travel; determined by orientation of the readhead
<b>Accuracy (at 20 °C)</b>	±3 µm
<b>Coefficient of thermal expansion</b>	~8 µm/m/°C
<b>Mass</b>	13.9 g/m

## RCLC glass spar lengths

Overall length L (mm)	Measuring length ML (mm)
10	7
18	15
30	27
55	52
80	77
100	97
105	102
130	127

# RCDM rotary disc installation drawing

Dimensions and tolerances in mm

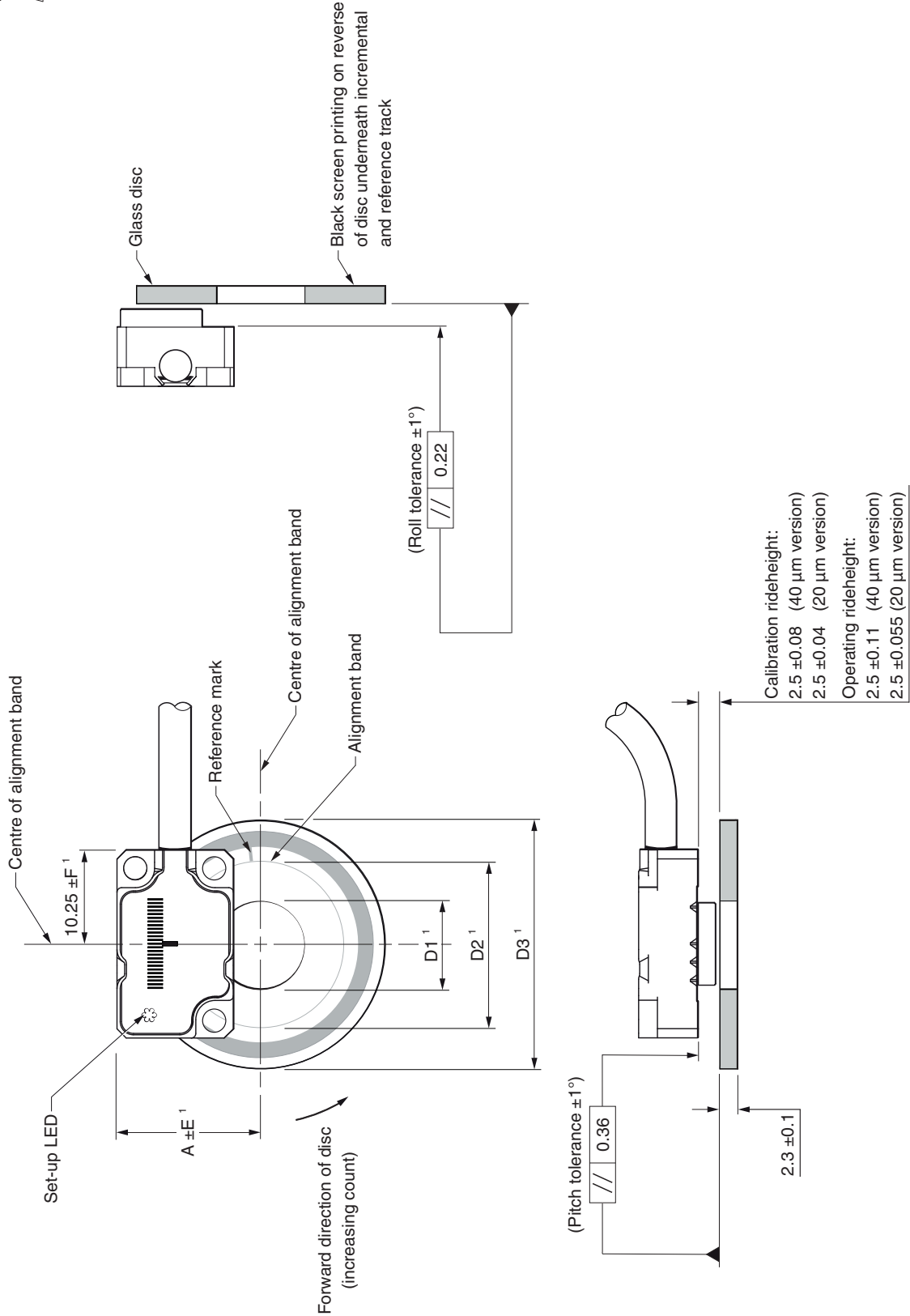

<sup>1</sup> The tolerances are defined on page 14 and the dimensions on page 15.

## RCDM rotary disc tolerances

### Radial and longitudinal tolerances

#### 20 µm discs

Optical diameter (mm)	Radial tolerance (mm)
OPD	E
< 30	0.100
< 60	0.125
< 80	0.150
≥ 80	0.200

Optical diameter (mm)	Longitudinal tolerance (mm)
OPD	F
< 50	0.075
< 60	0.100
< 80	0.125
< 100	0.175
≥ 100	0.225

#### 40 µm discs

Optical diameter (mm)	Radial tolerance (mm)
OPD	E
< 20	0.100
< 30	0.125
< 40	0.175
≥ 40	0.200

Optical diameter (mm)	Longitudinal tolerance (mm)
OPD	F
< 30	0.100
< 40	0.150
< 60	0.200
≥ 60	0.300

## RCDM rotary disc dimensions

### 20 µm discs

Optical diameter (mm)	Line count	Nominal outer diameter <sup>1</sup> (mm)	D1 (mm)	D2 (mm)	D3 (mm)	A (mm)
26.08	4 096	30	12.8	21.15	29.9	17.15
31.83	5 000	36	12.8	26.9	35.9	20.03
45.84	7 200	50	25.5	40.9	49.9	27.03
52.15	8 192	56	25.5	47.25	55.9	30.19
63.66	10 000	68	25.5	58.55	67.9	35.94
104.3	16 384	108	50.9	99.2	107.9	56.26

### 40 µm discs

Optical diameter (mm)	Line count	Nominal outer diameter <sup>1</sup> (mm)	D1 (mm)	D2 (mm)	D3 (mm)	A (mm)
13.04	1 024	17	3.275	8.1	16.9	10.63
15.92	1 250	20	3.275	11	19.9	12.07
21.01	1 650	25	6.46	16.1	24.9	14.62
22.92	1 800	27	9.625	18	26.9	15.57
26.08	2 048	30	12.8	21.15	29.9	17.15
31.83	2 500	36	12.8	26.9	35.9	20.03
45.84	3 600	50	25.5	40.9	49.9	27.03
52.15	4 096	56	25.5	47.25	55.9	30.19
63.66	5 000	68	25.5	58.55	67.9	35.94
104.3	8 192	108	50.9	99.2	107.9	56.26

<sup>1</sup> Special disc sizes are available on request

## RCDM rotary disc technical specifications

<b>Material</b>	Soda-lime glass
<b>Form</b>	2.3 mm thick
<b>Pitch</b>	20 µm and 40 µm
<b>Reference mark</b>	Single reference mark
<b>Coefficient of thermal expansion</b>	~8 µm/m/°C

## RCDM rotary disc graduation accuracy

<b>Optical diameter (mm)</b>	<b>Nominal outer diameter (mm)</b>	<b>Graduation accuracy (arc seconds)</b>
13.04	17	15.81
15.92	20	12.95
21.01	25	9.82
22.92	27	9
26.08	30	7.91
31.83	36	6.49
45.84	50	4.5
52.15	56	3.95
63.66	68	3.24
104.3	108	2.78



# ACi interface - FPC variant dimension drawing

Dimensions and tolerances in mm

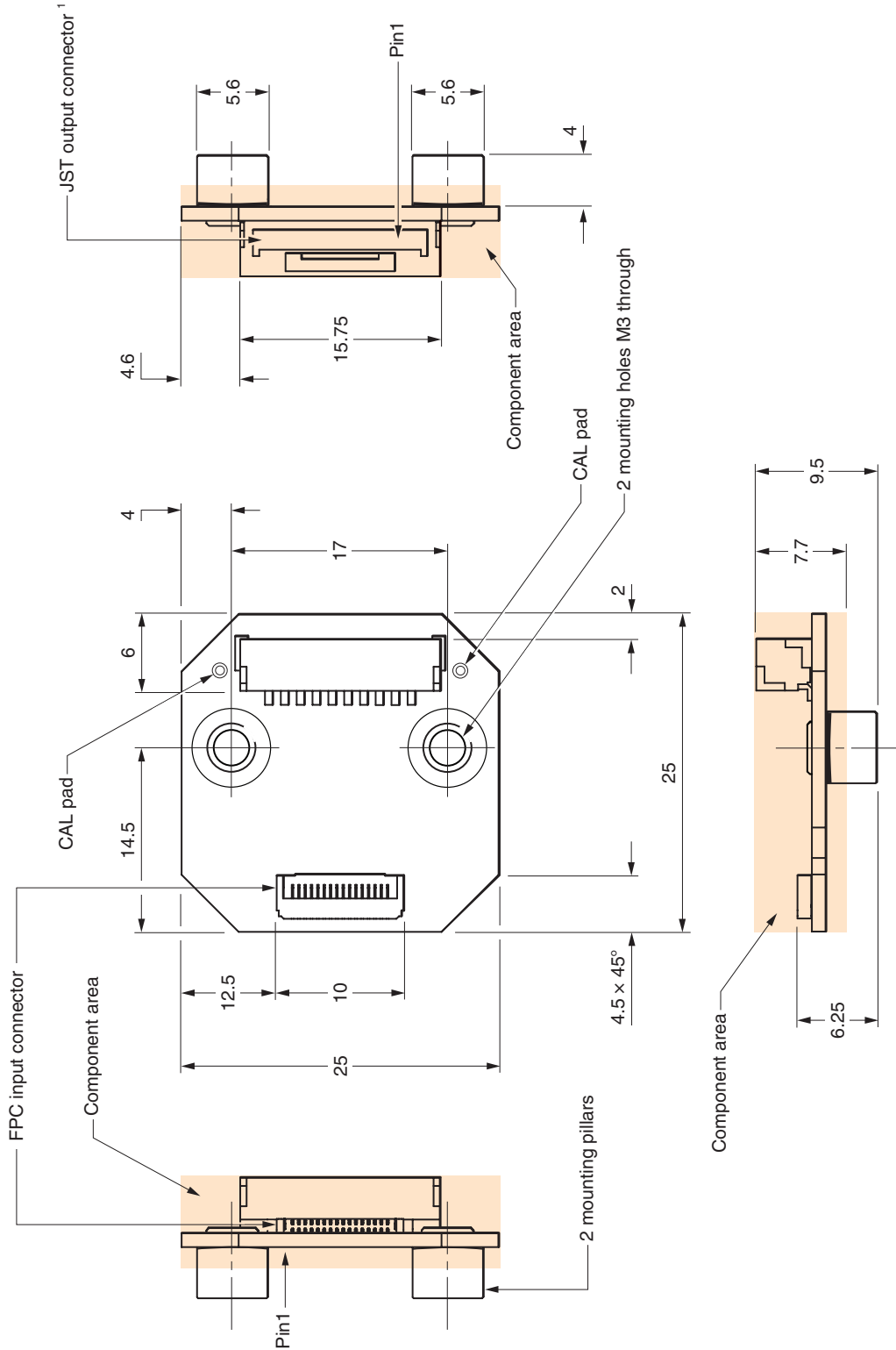

<sup>1</sup> 10 way JST, GH crimp connector. 1.25 mm pitch. Suitable for cable size 26 to 30 AWG.

# ACi interface - Cable variant dimension drawing

Dimensions and tolerances in mm

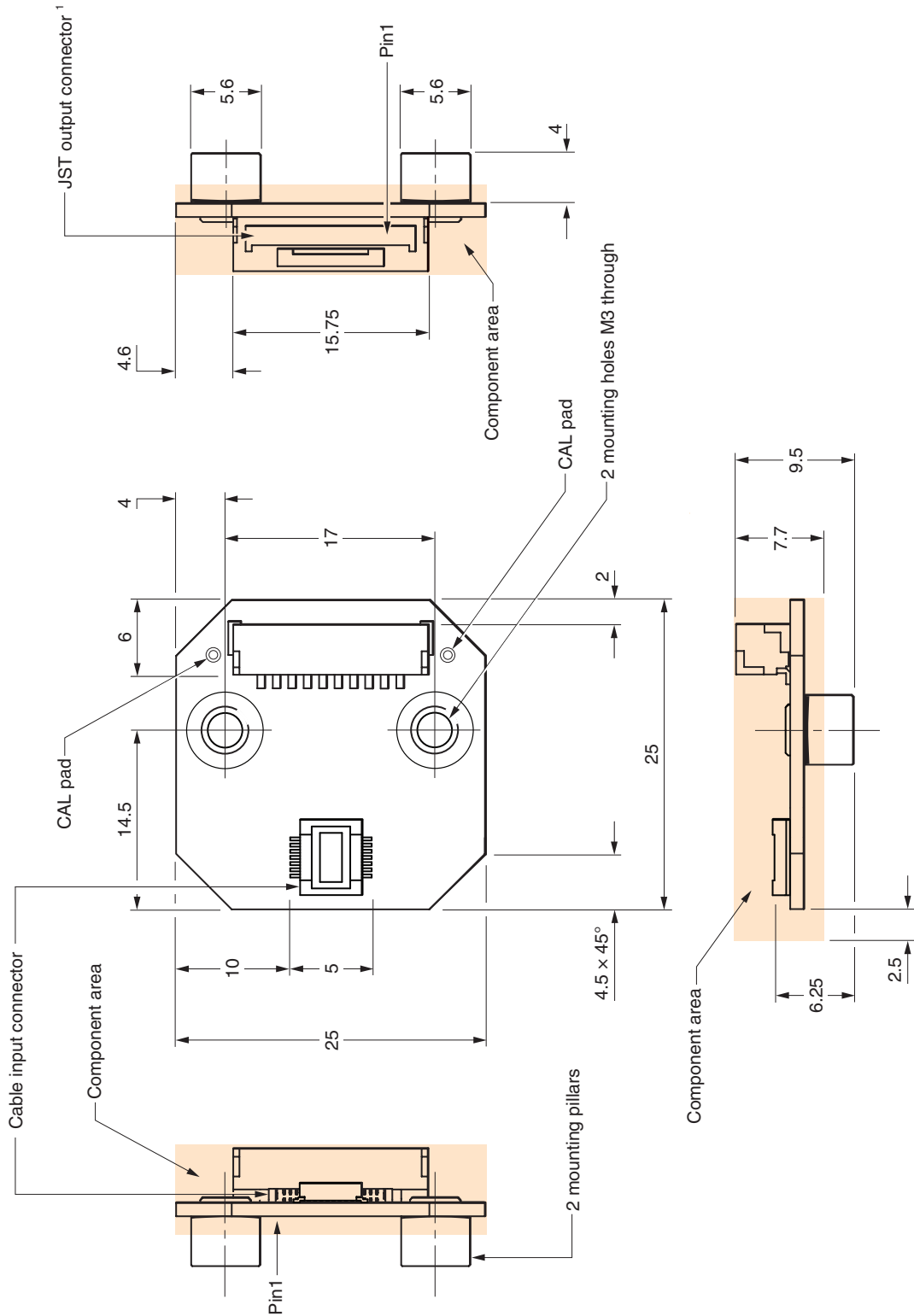

<sup>1</sup> 10 way JST, GH crimp connector. 1.25 mm pitch. Suitable for cable size 26 to 30 AWG.

# ACi interface - PCB mounting variant dimension drawing

Dimensions and tolerances in mm

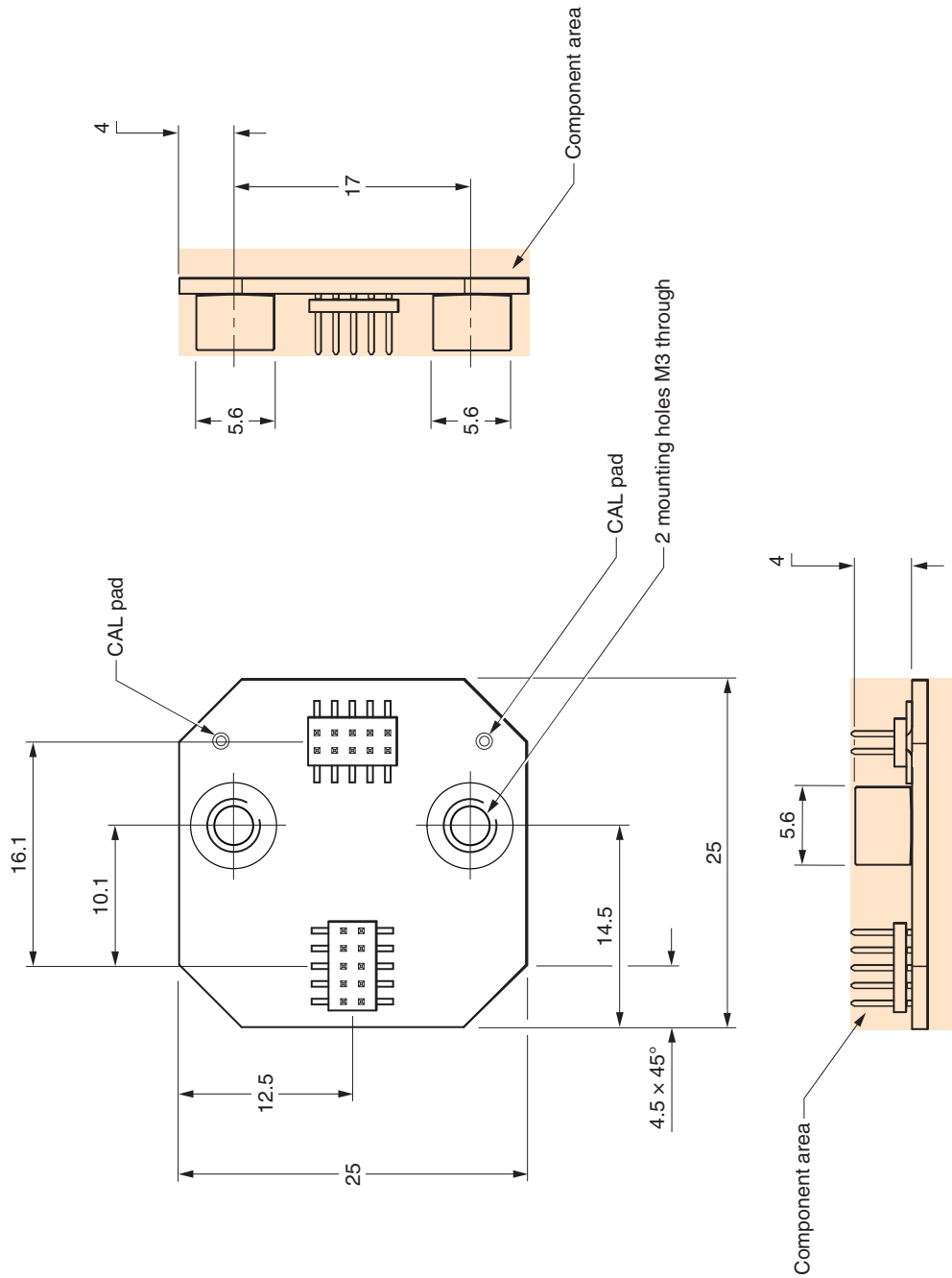

## ACi speed

### 20 µm encoder

Maximum speed (m/s)								Lowest recommended counter input frequency (MHz)
0020 (1 µm)	0040 (0.5 µm)	0080 (0.25 µm)	0100 (0.2 µm)	0200 (0.1 µm)	0400 (50 nm)	1000 (20 nm)	2000 (10 nm)	
6.5	6.5	6.5	5.8	3	-	-	-	40
6.5	6.5	4	3.2	1.6	-	-	-	20
-	-	-	-	-	0.35	0.13	0.06	12
6.5	4	2	1.6	0.8	-	-	-	10
-	-	-	-	-	0.18	0.06	0.03	6
4	2	1	0.8	0.4	-	-	-	5
-	-	-	-	-	0.12	0.04	0.02	4

### 40 µm encoder

Maximum speed (m/s)								Lowest recommended counter input frequency (MHz)
0020 (2 µm)	0040 (1 µm)	0080 (0.5 µm)	0100 (0.4 µm)	0200 (0.2 µm)	0400 (0.1 µm)	1000 (40 nm)	2000 (20 nm)	
13	13	13	11.6	6	-	-	-	40
13	13	8	6.4	3.2	-	-	-	20
-	-	-	-	-	0.7	0.26	0.12	12
13	8	4	3.2	1.6	-	-	-	10
-	-	-	-	-	0.36	0.12	0.06	6
8	4	2	1.6	0.8	-	-	-	5
-	-	-	-	-	0.24	0.08	0.04	4

## Angular speed

Angular speed depends on disc optical diameter. Use the following equation to convert to rev/min.

$$\text{Angular speed (rev/min)} = \frac{V \times 1000 \times 60}{\pi D} \quad \text{Where } V = \text{maximum linear speed (m/s) and } D = \text{optical diameter of chosen disc in mm}$$

# Ri interface dimension drawing

Dimensions and tolerances in mm

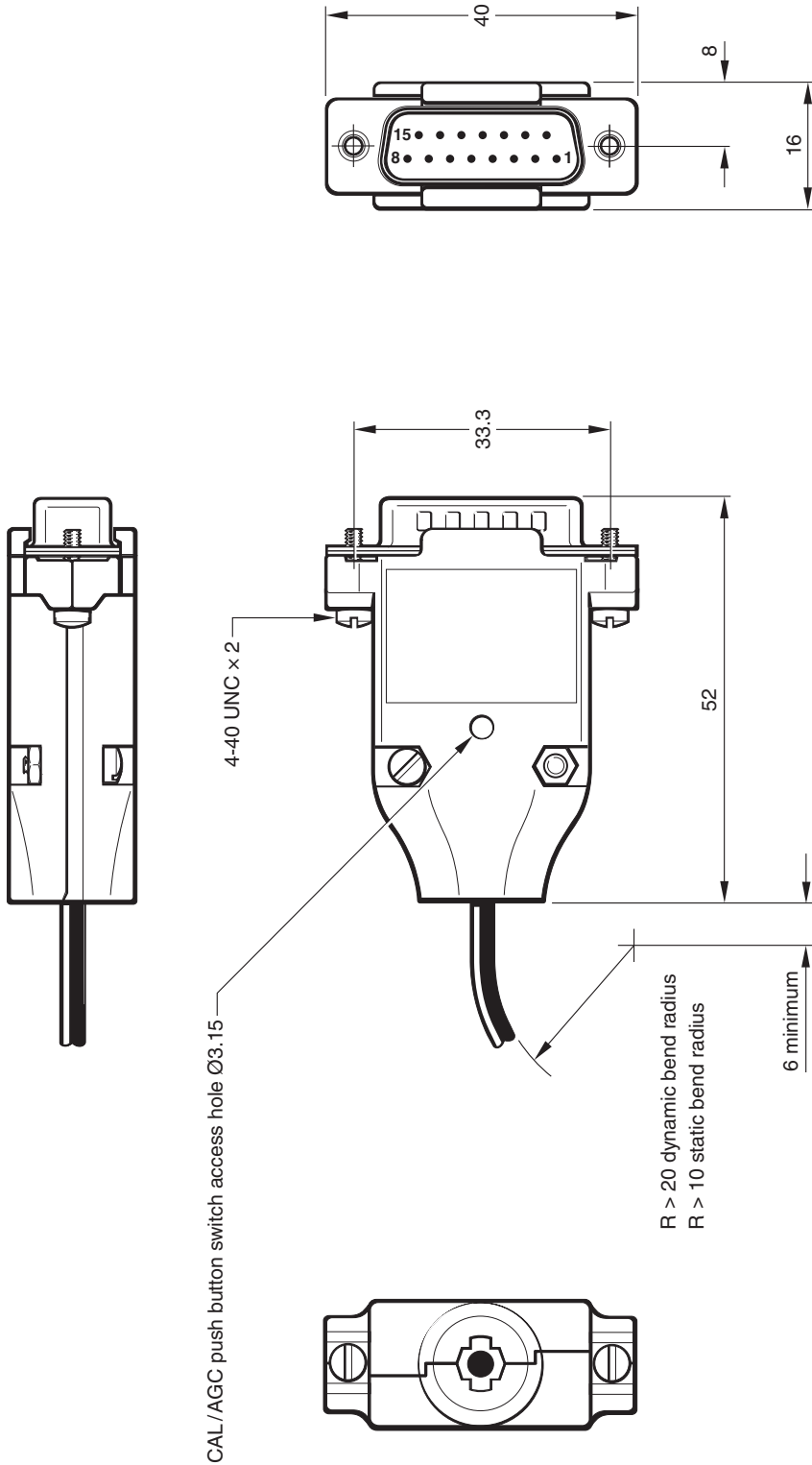

## Ri speed

### Clocked outputs

Ri0100, Ri0200 and Ri0400 interfaces have clocked outputs.

Customers must ensure they comply with the lowest recommended counter input frequency.

Maximum speed (m/s)						Lowest recommended counter input frequency (MHz)
20 µm system			40 µm system			
0100 (0.2 µm)	0200 (0.1 µm)	0400 (50 nm)	0100 (0.4 µm)	0200 (0.2 µm)	0400 (0.1 µm)	
-	0.8	0.4	-	1.6	0.8	12
-	0.5	0.25	-	1	0.5	10
0.8	0.4	0.2	1.6	0.8	0.4	6
0.5	0.25	0.12	1	0.5	0.24	4

### Non-clocked outputs

Ri0004, Ri0008, Ri0020 and Ri0040 interfaces have non-clocked outputs.

20 µm system		40 µm system		Lowest recommended counter input frequency (MHz)
Interface type	Maximum speed (m/s)	Interface type	Maximum speed (m/s)	
0004 (5 µm)	10	0004 (10 µm)	20	$\left( \frac{\text{Encoder velocity (m/s)}}{\text{Resolution (µm)}} \right) \times 4 \text{ safety factor}$
0008 (2.5 µm)	10	0008 (5 µm)	20	
0020 (1 µm)	10	0020 (2 µm)	20	
0040 (0.5 µm)	10	0040 (1 µm)	20	

### Analogue outputs

40 µm system - 20 m/s (-3dB)

20 µm system - 10 m/s (-3dB)

### Angular speed

Angular speed depends on disc optical diameter. Use the following equation to convert to rev/min.

$$\text{Angular speed (rev/min)} = \frac{V \times 1000 \times 60}{\pi D} \quad \text{Where } V = \text{maximum linear speed (m/s)} \text{ and } D = \text{optical diameter of chosen disc in mm}$$

## Ti interface dimension drawing

Dimensions and tolerances in mm

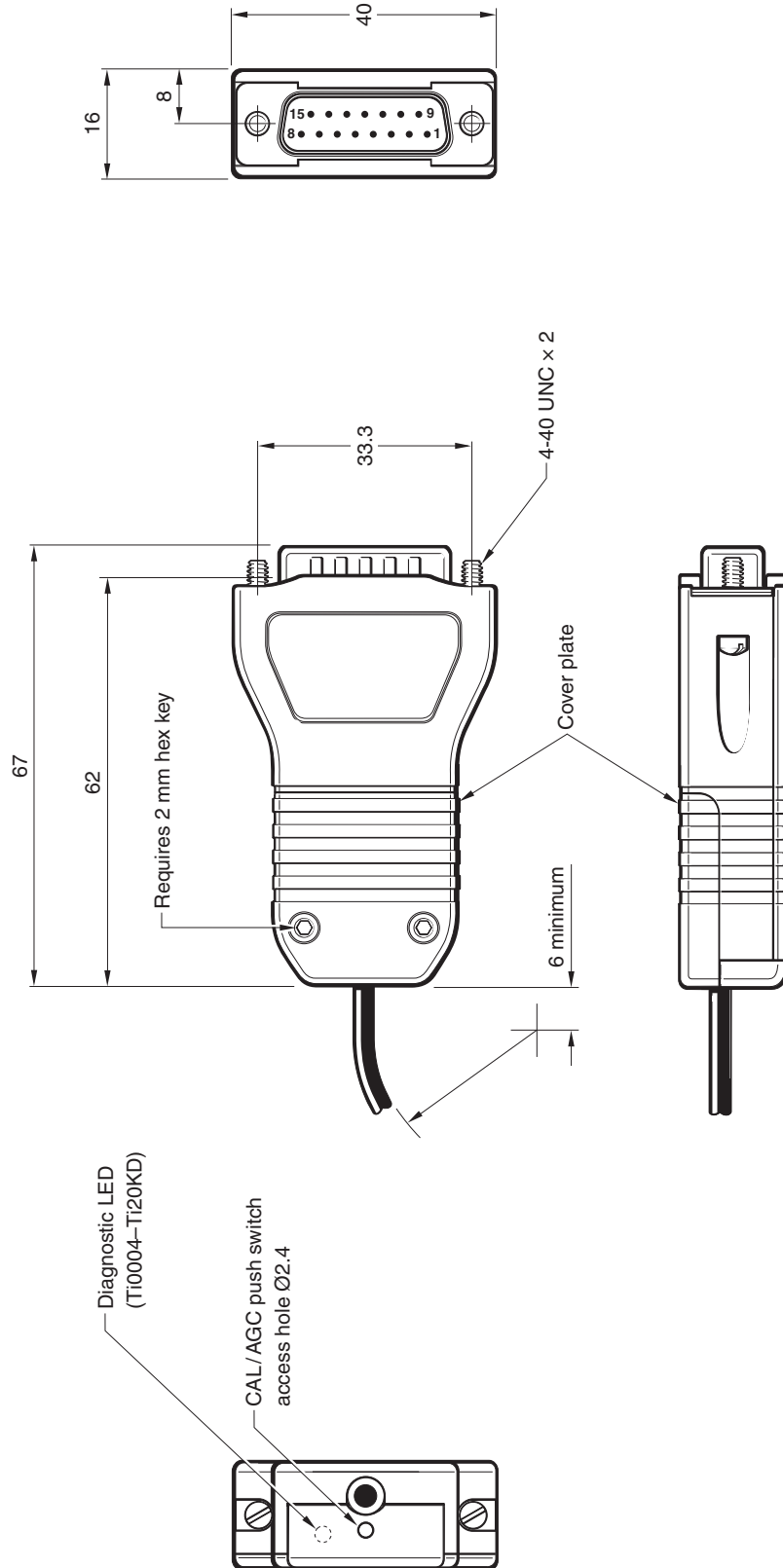

## Ti speed

### 20 µm system

Maximum speed (m/s)											Lowest recommended counter input frequency (MHz)
Ti0004 5 µm	Ti0020 1 µm	Ti0040 0.5 µm	Ti0100 0.2 µm	Ti0200 0.1 µm	Ti0400 50 nm	Ti1000 20 nm	Ti2000 10 nm	Ti4000 5 nm	Ti10KD 2 nm	Ti20KD 1 nm	
10	10	10	6.48	3.24	1.62	0.648	0.324	0.162	0.0654	0.032	50
10	10	10	5.4	2.7	1.35	0.54	0.27	0.135	0.054	0.027	40
10	10	8.1	3.24	1.62	0.81	0.324	0.162	0.081	0.032	0.016	25
10	10	6.75	2.7	1.35	0.675	0.27	0.135	0.068	0.027	0.013	20
10	9	4.5	1.8	0.9	0.45	0.18	0.09	0.045	0.018	0.009	12
10	8.1	4.05	1.62	0.81	0.405	0.162	0.081	0.041	0.016	0.0081	10
10	6.48	3.24	1.29	0.648	0.324	0.13	0.065	0.032	0.013	0.0065	8
10	4.5	2.25	0.9	0.45	0.225	0.09	0.045	0.023	0.009	0.0045	6
10	3.37	1.68	0.67	0.338	0.169	0.068	0.034	0.017	0.0068	0.0034	4
4.2	0.84	0.42	0.16	0.084	0.042	0.017	0.008	0.004	0.0017	0.0008	1

### 40 µm system

Maximum speed (m/s)											Lowest recommended counter input frequency (MHz)
Ti0004 10 µm	Ti0020 2 µm	Ti0040 1 µm	Ti0100 0.4 µm	Ti0200 0.2 µm	Ti0400 0.1 µm	Ti1000 40 nm	Ti2000 20 nm	Ti4000 10 nm	Ti10KD 4 nm	Ti20KD 2 nm	
20	20	20	12.96	6.48	3.25	1.296	0.648	0.324	0.13	0.064	50
20	20	20	10.8	5.4	2.7	1.08	0.54	0.27	0.108	0.054	40
20	20	16.2	6.48	3.24	1.62	0.648	0.324	0.162	0.064	0.032	25
20	20	13.5	5.4	2.7	1.34	0.54	0.27	0.136	0.054	0.026	20
20	18	9	3.6	1.8	0.9	0.36	0.18	0.09	0.036	0.018	12
20	16.2	8	3.24	1.62	0.8	0.324	0.162	0.082	0.032	0.0162	10
20	12.96	6.48	2.58	1.296	0.648	0.26	0.13	0.064	0.026	0.013	8
20	9	4.5	1.8	0.9	0.45	0.18	0.09	0.046	0.018	0.009	6
20	6.74	3.36	1.34	0.676	0.338	0.136	0.068	0.034	0.0136	0.0068	4
8.4	1.68	0.84	0.32	0.168	0.084	0.034	0.016	0.008	0.0034	0.0016	1

### Analogue speed

40 µm system - 20 m/s (-3dB)

20 µm system - 10 m/s (-3dB)

### Angular speed

Angular speed depends on disc optical diameter. Use the following equation to convert to rev/min.

$$\text{Angular speed (rev/min)} = \frac{V \times 1000 \times 60}{\pi D} \quad \text{Where } V = \text{maximum linear speed (m/s) and } D = \text{optical diameter of chosen disc in mm}$$



## Interface signals

### ACi FPC and cable variant interface (digital output only)

Function	Input				Output		
	Signal	Cable		FPC	JST		
		Colour	Pin	Pin	Signal	Pin	
Power <sup>1</sup>	5 V	Brown	4	7, 8	5 V	9	
	0 V	White	13	3, 6, 11, 14	0 V	10	
Incremental	V <sub>1</sub>	+	Red	9	A	+	1
		-	Blue	5		-	2
	V <sub>2</sub>	+	Yellow	12	B	+	3
		-	Green	14		-	4
Reference mark	V <sub>0</sub>	+	Violet	2	Z	+	5
		-	Grey	8		-	6
Set-up	V <sub>x</sub>	Clear	6	1	X	7	
Remote CAL	CAL	Orange	10	2	CAL	8	
Shield	-	Screen	Cable ferrule	-	-	-	
Do not connect	-	-	1, 3, 7, 11	9, 10	-	-	

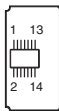

Cable variant input connector

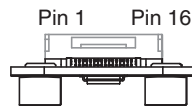

ACi FPC input connector

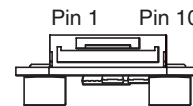

ACi JST output connector

<sup>1</sup> All power connections can be used either to minimise voltage drop down the cable or incorporate voltage sensing.

**ACi PCB mounting variant interface** (digital output only)

Function	Input		Output			
	Signal	Pin	Signal	Pin		
Power	5 V	9	5 V	6		
	0 V	2	0 V	5		
Incremental	V <sub>1</sub>	+	4	A	+	8
		-	6	A	-	10
	V <sub>2</sub>	+	3	B	+	7
		-	1	B	-	9
Reference mark	V <sub>0</sub>	+	8	Z	+	3
		-	10	Z	-	1
Remote CAL	V <sub>x</sub>	7	X	4		
Shield	CAL	5	CAL	2		

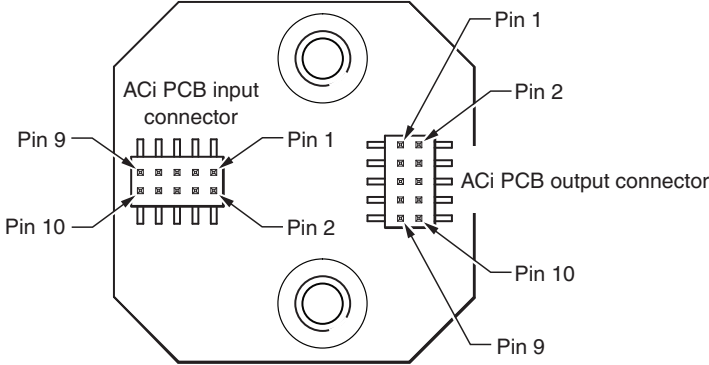

## Interface signals

### Ri and Ti interfaces

Function	Digital		Analogue				
	Signal	Pin	Signal	Pin (standard)	Pin <sup>1</sup> (alternative)		
Power <sup>2</sup>	5 V	7, 8	5 V	4, 5	4, 12		
	0 V	2, 9	0 V	12, 13	2, 10		
Incremental signals	A	+	14	V <sub>1</sub>	+	9	1
		-	6		-	1	9
	B	+	13	V <sub>2</sub>	+	10	3
		-	5		-	2	11
Reference mark	Z	+	12	V <sub>0</sub>	+	3	14
		-	4		-	11	7
Alarm <sup>3</sup>	E	+	11	-	-	-	-
		-	3				
Set-up	X	1	V <sub>x</sub>	6	13		
Remote CAL	-	-	CAL	14	5		
Shield	-	Case	-	Case	Case		
Do not connect	-	10, 15	-	7, 8, 15	6, 8, 15		

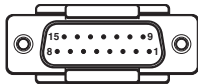

Ri connector

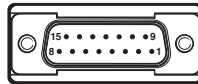

Ti connector

<sup>1</sup> Ri interface only.

<sup>2</sup> All power connections should be used either to minimise voltage drop down the cable or incorporate voltage sensing.

<sup>3</sup> The alarm signal can be output as a line driven signal or 3-state. Select the preferred option at time of ordering.

## General specifications

<b>Power supply</b> <sup>1</sup>	5 V ±10%	<p>ATOM readhead typically &lt; 50 mA</p> <p>ATOM with ACi typically &lt; 100 mA</p> <p>ATOM with Ri typically &lt; 100 mA</p> <p>ATOM with Ti typically &lt; 200 mA</p> <p>For analogue outputs a further 10 mA in total will be drawn when terminated with 120R</p> <p>For digital outputs a further 25 mA per channel pair (eg A+, A-) will be drawn when terminated with 120R</p> <p>Power from a 5 Vdc supply complying with the requirements for SELV of standard IEC 60950-1</p>
	Ripple	200 mVpp maximum@frequency up to 500 kHz
<b>Temperature</b>	Storage	-20 °C to +70 °C
	Operating	0 °C to +70 °C
<b>Humidity</b>		95% relative humidity (non-condensing) to IEC 60068-2-78
<b>Sealing</b>	Cable variant	IP40
	FPC variant	IP20 (with lid fitted)
	Ri interface	IP20
	Ti interface	IP20
<b>Acceleration (system)</b>	Operating	400 m/s <sup>2</sup> , 3 axes
<b>Shock (system)</b>	Operating	1000 m/s <sup>2</sup> , 6 ms, ½ sine, 3 axes
<b>Vibration</b>	Operating	Sinusoidal 100 m/s <sup>2</sup> max @ 55 Hz to 2000 Hz, 3 axes
<b>Mass</b>	Cable readhead	4 g
	FPC readhead	2.3 g
	Cable	18 g/m
	Ti interface	100 g
	Ri interface	70 g
	ACi interface	4 g
<b>Readhead cable</b>		<p>10 core, high flex, EMI screened cable, outside diameter 3.5 mm maximum</p> <p>Flex life &gt; 20 × 10<sup>6</sup> cycles at 20 mm bend radius, maximum length 5 m (Extension cable up to 25 m when using Renishaw approved extension cable)</p> <p>UL recognised component </p>
<b>FPC cable</b>		16 core, 0.5 mm pitch, maximum exposed conductor length 2.5 mm, maximum length 1 m
<b>Connector options</b>	Cable variants	Interboard connector compatible with the Ri, Ti and ACi (cable variant) interfaces
	FPC	15-way, D-type connector 16 core, 0.5 mm pitch, compatible with ACi (FPC variant)
<b>Typical SDE (analogue)</b>	20 µm version	< ±75 nm
	40 µm version	< ±120 nm

<sup>1</sup> Current consumption figures refer to unterminated systems.

## Electrical connections

### Grounding and shielding

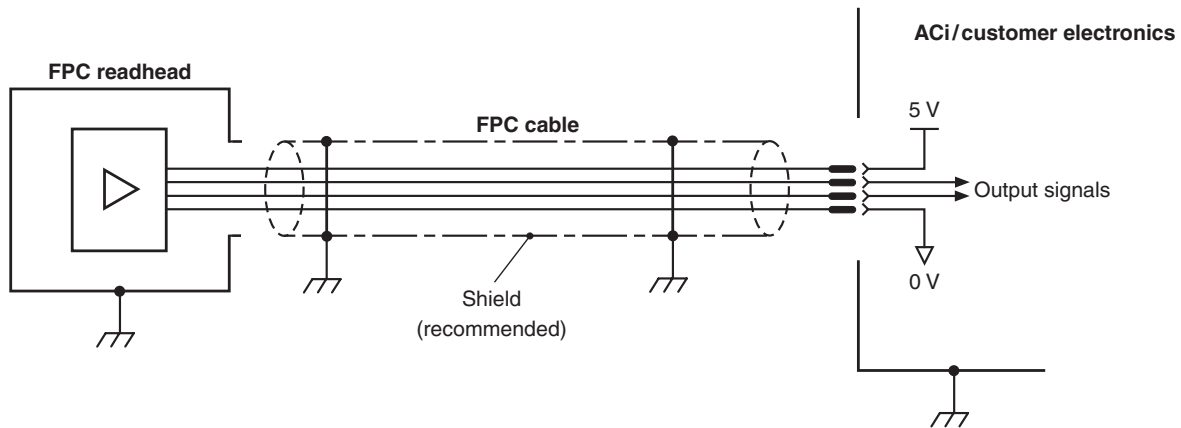

For more information on FPC refer to the installation guide.

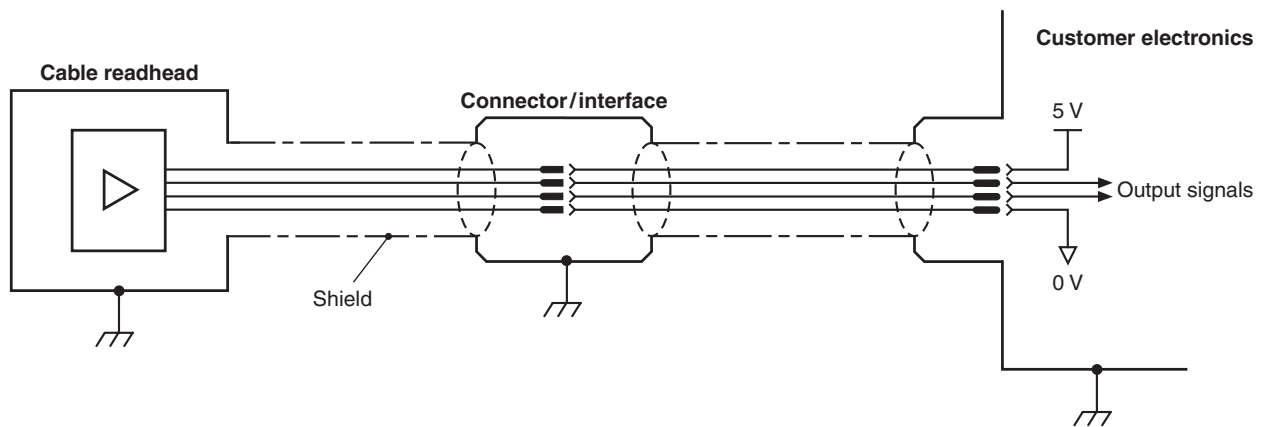

**IMPORTANT:** The shield should be connected to the machine earth (Field Ground).

**NOTE:** Maximum cable length between interface and customer electronics is 25 m for ACi and Ri and 50 m for Ti depending on clocked output.

## Recommended signal termination

### Digital outputs

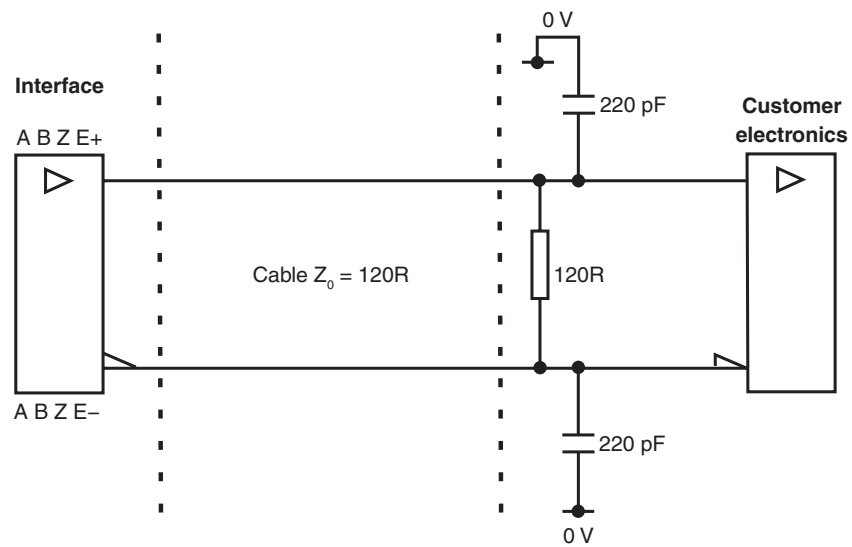

Standard RS422A line receiver circuitry.

Capacitors recommended for improved noise immunity.

### Analogue outputs

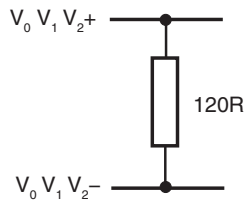

### Remote CAL operation

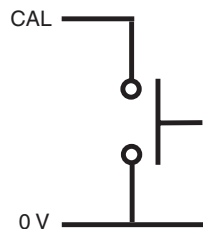

Remote operation of the CAL is possible via the CAL pin.  
For applications where no interface is used, remote CAL operation is essential.

# Output specifications

## Analogue output signals

All ATOM readheads and Ri and Ti analogue interfaces

### Incremental

2 channels  $V_1$  and  $V_2$  differential sinusoids in quadrature, centred ~ 1.65 V (90° phase shifted)

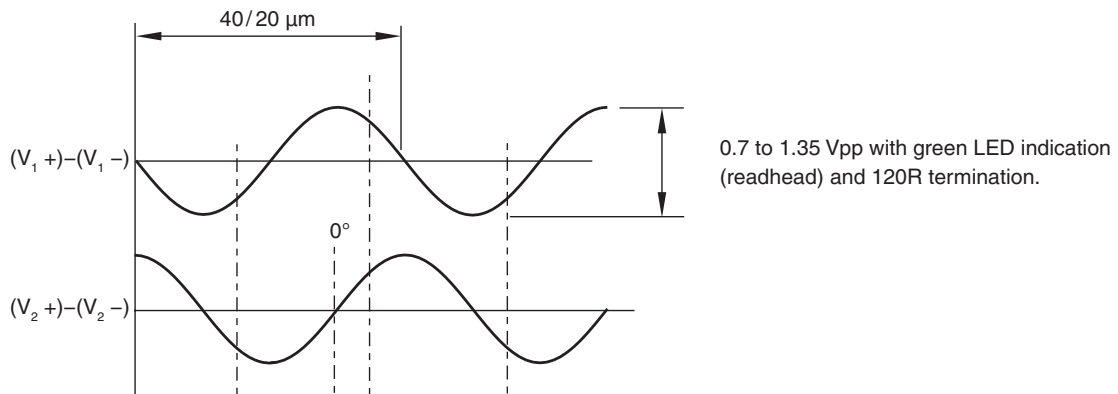

### Reference

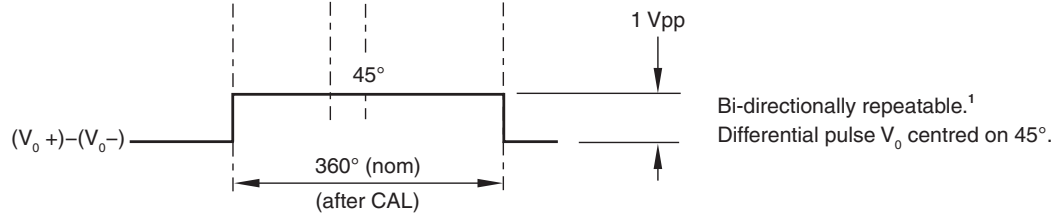

Differential signals  $V_0+$  and  $V_0-$  centred on ~ 1.65 V.

<sup>1</sup> Only the calibrated reference mark is bi-directionally repeatable.

**Set-up**

**During normal operation**

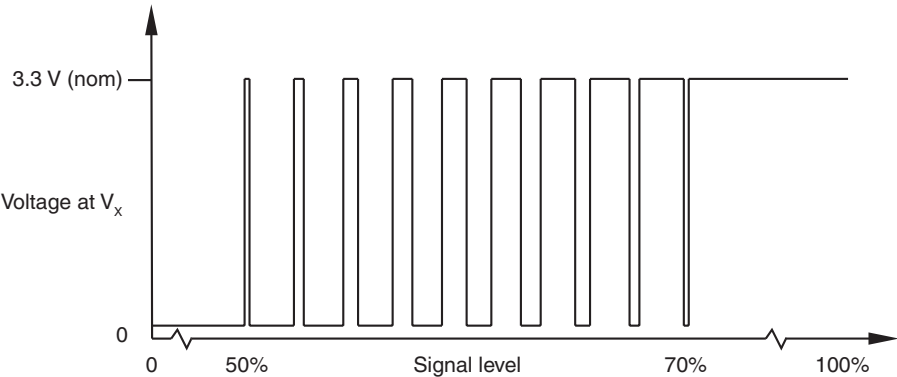

Between 50% and 70% signal level, V<sub>x</sub> is a duty cycle.  
 Time spent at 3.3 V increases with incremental signal level.  
 At > 70% signal level V<sub>x</sub> is nominal 3.3 V.

**During CAL routine**

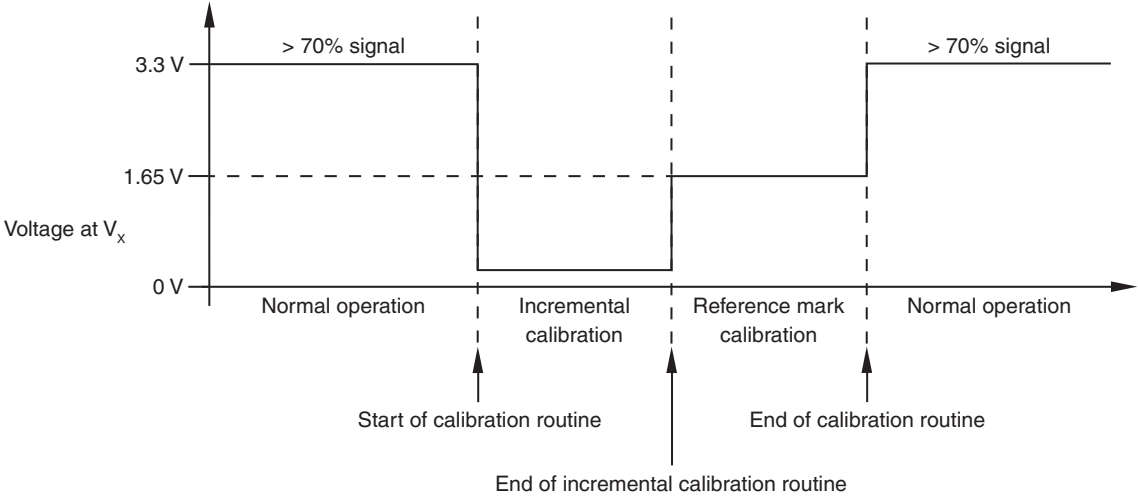



## Digital output signals

Form - Square wave differential line driver to EIA RS422A

All ACi interfaces, Ri digital interfaces, and Ti digital interface

### Incremental<sup>1</sup>

2 channels A and B in quadrature (90° phase shifted)

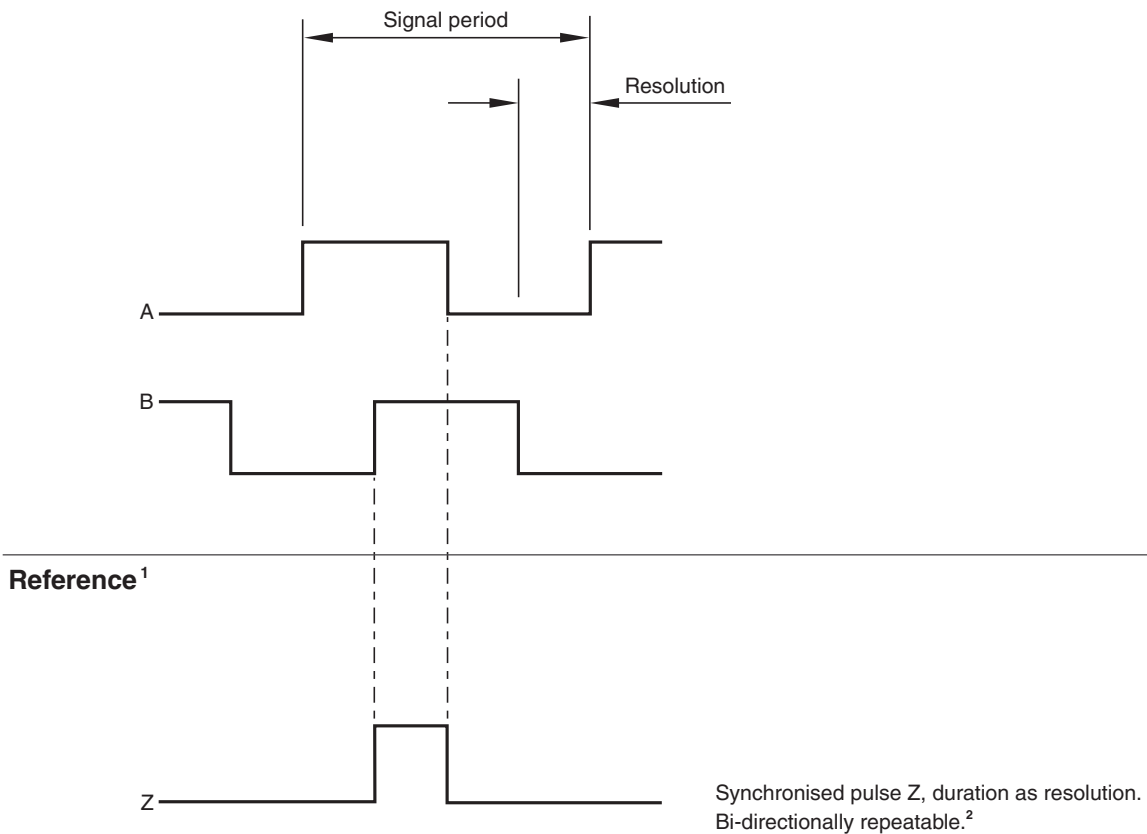

<sup>1</sup> For clarity, the inverse signals are not shown.

<sup>2</sup> Only the calibrated reference mark is bi-directionally repeatable.

### Set-up (ACi interfaces and Ri digital interfaces)

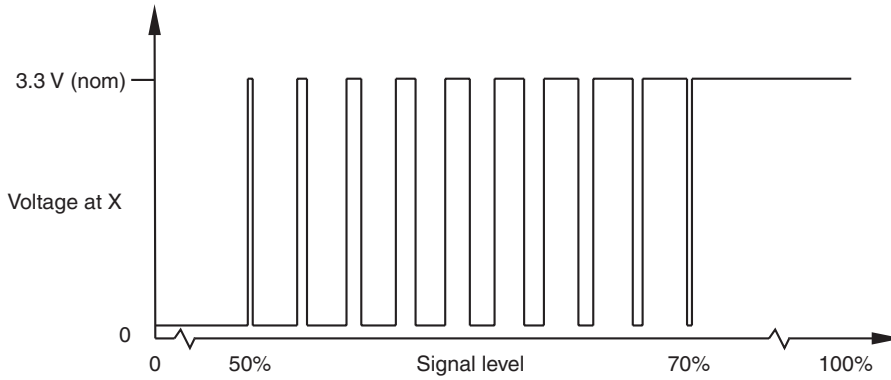

Between 50% and 70% signal level, X is a duty cycle.

Time spent at 3.3 V increases with incremental signal level.

At > 70% signal level X is nominal 3.3 V.

### Set-up <sup>1</sup> (Ti digital interfaces only)

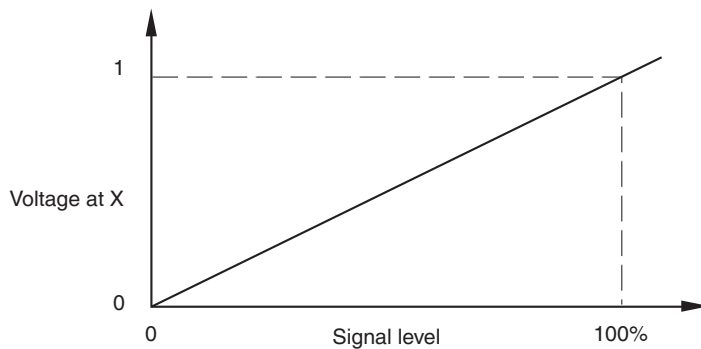

Set-up signal voltage proportional to incremental signal amplitude.

<sup>1</sup> The set-up signal as shown is not present during the calibration routine.

## Alarm<sup>1</sup>

Differential line driven alarm output (Ri digital interfaces and Ti digital interfaces)

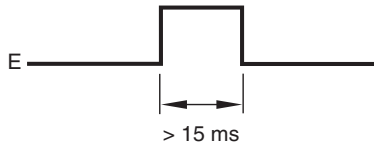

Interface model	Alarm asserted when
Ri0004	<ul style="list-style-type: none"> <li>• &lt; 40% signal</li> <li>• Overspeed</li> </ul>
Ri0008	
Ri0020	
Ri0040	
Ri0100	<ul style="list-style-type: none"> <li>• &lt; 20% signal</li> <li>• &gt; 130% signal</li> </ul>
Ri0200	
Ri0400	

Interface model	Alarm asserted when
Ti	<ul style="list-style-type: none"> <li>• &lt; 20% signal</li> <li>• &gt; 135% signal</li> <li>• Overspeed</li> </ul>

**3-state alarm output** (ACi interfaces, Ri digital interfaces, and Ti digital interfaces)

Differentially transmitted signals forced open circuit for > 15 ms when alarm conditions valid.

<sup>1</sup> For clarity, the inverse signals are not shown.

## ATOM 20 µm part numbers

**ATOM 2 F 0 - 000**

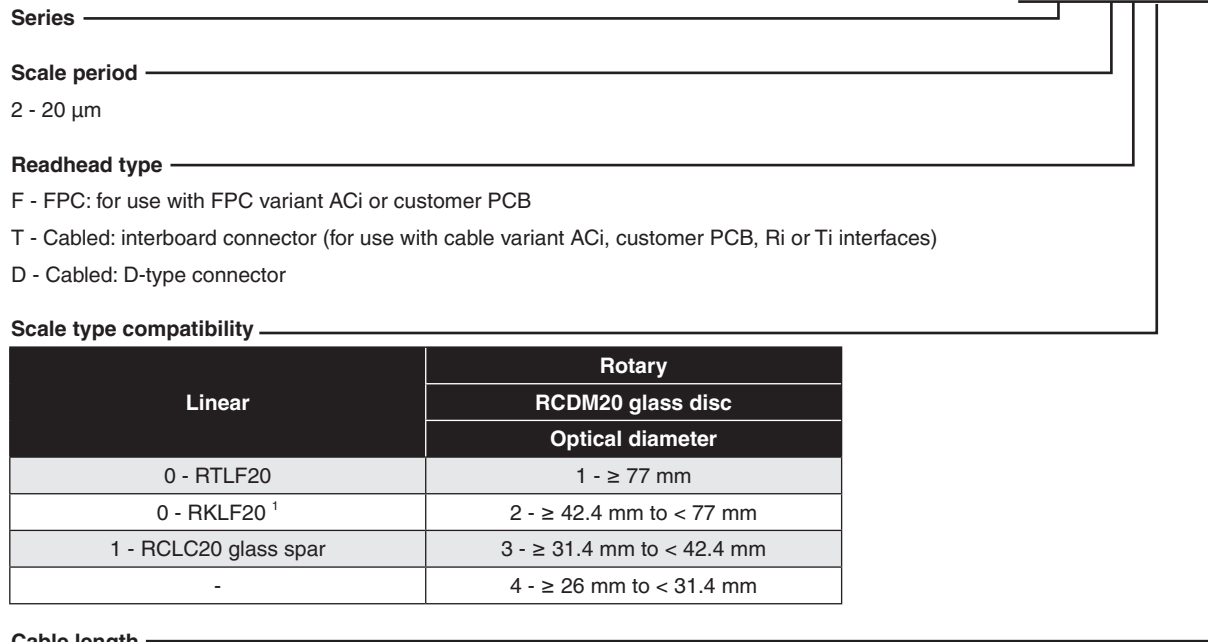

000 - FPC	100 - 1000 mm
020 - 200 mm	150 - 1500 mm
030 - 300 mm	200 - 2000 mm
050 - 500 mm	300 - 3000 mm
080 - 800 mm	500 - 5000 mm

<sup>1</sup> RKLF20 is not suitable for partial arc applications.

## ATOM 40 µm part numbers

**ATOM 4 F 0 - 000**

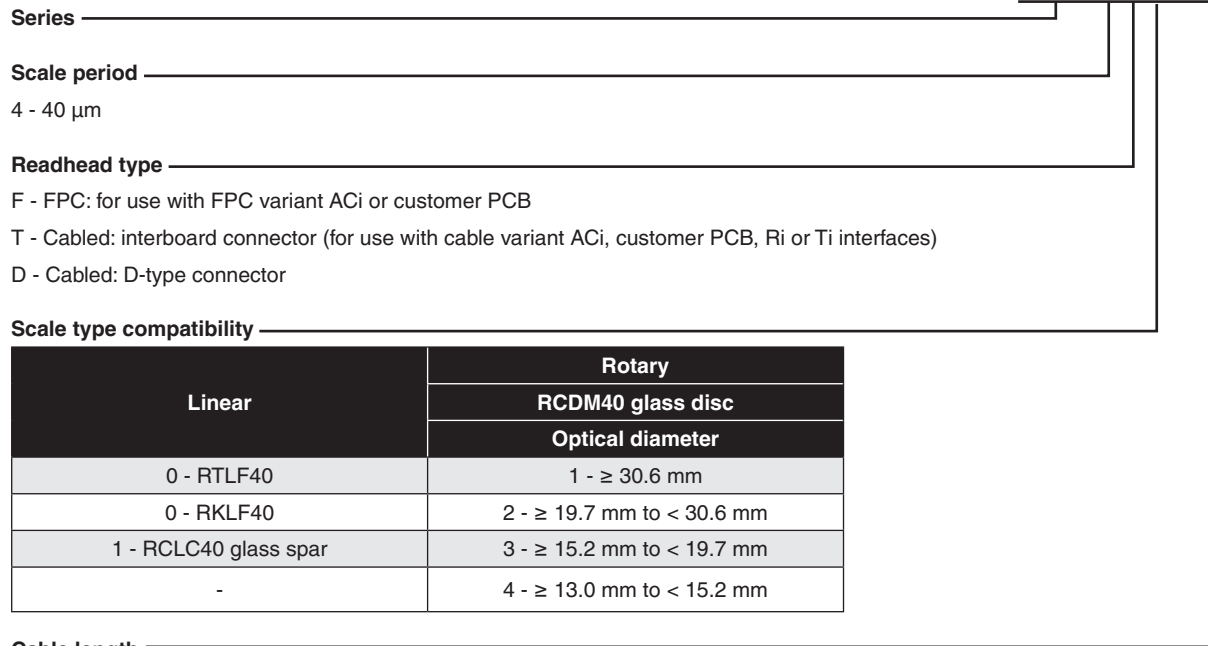

**Cable length** \_\_\_\_\_

000 - FPC	100 - 1000 mm
020 - 200 mm	150 - 1500 mm
030 - 300 mm	200 - 2000 mm
050 - 500 mm	300 - 3000 mm
080 - 800 mm	500 - 5000 mm

## Linear scale part numbers

### RTLF tape scale

Scale type	Scale pitch	Length	Increments	Part number (where xxxx is the length in cm) <sup>1</sup>	ATOM readhead scale type compatibility
RTLF20-S	20 µm	20 mm to 1 m	10 mm	A-9406-xxxx	0
		1 m to 10 m <sup>2</sup>	1 m		
RTLF40H-S	40 µm (high accuracy)	20 mm to 1 m	10 mm	A-9408-xxxx	0
		1 m to 10 m <sup>2</sup>	1 m		
RTLF40-S	40 µm	20 mm to 1 m	10 mm	A-9407-xxxx	0
		1 m to 10 m <sup>2</sup>	1 m		

### RKLF mastered tape scale

Scale type	Scale pitch	Length	Increments	Part number (where xxxx is the length in cm) <sup>3</sup>	ATOM readhead scale type compatibility
RKLF20-S	20 µm <sup>4</sup>	20 mm to 1 m	10 mm	A-6767-xxxx	0
		1 m to 10 m	1 m		
RKLF40H-S	40 µm (high accuracy) <sup>4</sup>	20 mm to 1 m	10 mm	A-6771-xxxx	0
		1 m to 10 m	1 m		
RKLF40	40 µm	20 mm to 1 m	10 mm	A-6769-xxxx	0
		1 m to 10 m	1 m		

### RCLC glass spar

Length (mm)	20 µm	40 µm	ATOM readhead scale type compatibility
10	A-9404-2010	A-9404-4010	1
18	A-9404-2018	A-9404-4018	1
30	A-9404-2030	A-9404-4030	1
55	A-9404-2055	A-9404-4055	1
80	A-9404-2080	A-9404-4080	1
100	A-9404-2100	A-9404-4100	1
105	A-9404-2105	A-9404-4105	1
130	A-9404-2130	A-9404-4130	1

<sup>1</sup> Ordering A-9408-0070 for example will result in a 70 cm length of RTLF40H-S scale.

<sup>2</sup> Lengths greater than 10 m are available on request.

<sup>3</sup> Ordering A-6767-0070 for example will result in a 70 cm length of RKLF20-S scale.

<sup>4</sup> Not recommended for partial arc applications.

## Rotary disc part numbers

### RCDM rotary discs (20 µm version)

Optical diameter (mm)	Nominal outer diameter (mm)	Part number	ATOM readhead scale type compatibility
26.08	30	A-9405-2030	4
31.83	36	A-9405-2036	3
45.84	50	A-9405-2050	2
52.15	56	A-9405-2056	2
63.66	68	A-9405-2068	2
104.3	108	A-9405-2108	1

### RCDM rotary discs (40 µm version)

Optical diameter (mm)	Nominal outer diameter (mm)	Part number	ATOM readhead scale type compatibility
13.04	17	A-9405-4017	4
15.92	20	A-9405-4020	3
21.01	25	A-9405-4025	2
22.92	27	A-9405-4027	2
26.08	30	A-9405-4030	2
31.83	36	A-9405-4036	1
45.84	50	A-9405-4050	1
52.15	56	A-9405-4056	1
63.66	68	A-9405-4068	1
104.3	108	A-9405-4108	1

---

**NOTE:** Other disc diameters are available; contact your local Renishaw representative for more information.

---

# Interface part numbers

## ACi interface

**ACi 0020 A 40 A**

Series

Interpolation factor

Interpolation factor	Resolution	
	20 µm system	40 µm system
0020	1 µm	2 µm
0040	0.5 µm	1 µm
0080	0.25 µm	0.5 µm
0100	0.2 µm	0.4 µm
0200	0.1 µm	0.2 µm
0400	50 nm	0.1 µm
1000	20 nm	40 nm
2000	10 nm	20 nm

PCB type

A - FPC input connector

B - Cable input connector

C - Pin headers for PCB mounting

Clocked output option

40 - 40 MHz (0020, 0040, 0080, 0100, and 0200 interpolation factors only)

20 - 20 MHz (0020, 0040, 0080, 0100, and 0200 interpolation factors only)

12 - 12 MHz (0400, 1000, and 2000 interpolation factors only)

10 - 10 MHz (0020, 0040, 0080, 0100, and 0200 interpolation factors only)

06 - 6 MHz (0400, 1000, and 2000 interpolation factors only)

05 - 5 MHz (0020, 0040, 0080, 0100, and 0200 interpolation factors only)

04 - 4 MHz (0400, 1000, and 2000 interpolation factors only)

Options

A - Standard



# Interface part numbers

## Ri interface

### Analogue

**Ri 0000 A 00 A**

Pinout

- A - Standard
- H - Alternative

### Digital

**Ri 0400 A 12 B**

Series

Interpolation factor

Interpolation factor	Resolution	
	20 µm system	40 µm system
0004	5 µm	10 µm
0008	2.5 µm	5 µm
0020	1 µm	2 µm
0040	0.5 µm	1 µm
0100	0.2 µm	0.4 µm
0200	0.1 µm	0.2 µm
0400	50 nm	0.1 µm

Alarm format

- A - Line driven
- E - 3-state

Clocked output option

- 12 - 12 MHz (0200 and 0400 interpolation factors only)
- 10 - 10 MHz (0200 and 0400 interpolation factors only)
- 06 - 6 MHz (0100, 0200, and 0400 interpolation factors only)
- 04 - 4 MHz (0100, 0200, and 0400 interpolation factors only)
- 00 - Non-clocked (0004, 0008, 0020, and 0040 interpolation factors only)

Options

- B - Standard

## Interface part numbers

### Ti interface

#### Analogue

**Ti 0000 A 00 A**

#### Options

A - Vmid - 1.65 V

V - Vmid - 2.5 V

#### Digital

**Ti 0200 A 20 E**

#### Series

#### Interpolation factor

Interpolation factor	Resolution	
	20 µm system	40 µm system
0004	5 µm	10 µm
0020	1 µm	2 µm
0040	0.5 µm	1 µm
0100	0.2 µm	0.4 µm
0200	0.1 µm	0.2 µm
0400	50 nm	0.1 µm
1000	20 nm	40 nm
2000	10 nm	20 nm
4000	5 nm	10 nm
10KD	2 nm	4 nm
20KD	1 nm	2 nm

#### Alarm format

A - Line driven; all alarms

B - Line driven; low signal and high signal alarms

E - 3-state; all alarms

F - 3-state; low signal and high signal alarms

#### Clocked output option

50 - 50 MHz	10 - 10 MHz
40 - 40 MHz	08 - 8 MHz
25 - 25 MHz	06 - 6 MHz
20 - 20 MHz	04 - 4 MHz
12 - 12 MHz	01 - 1 MHz

#### Options

E - Standard

# ATOM compatible scales

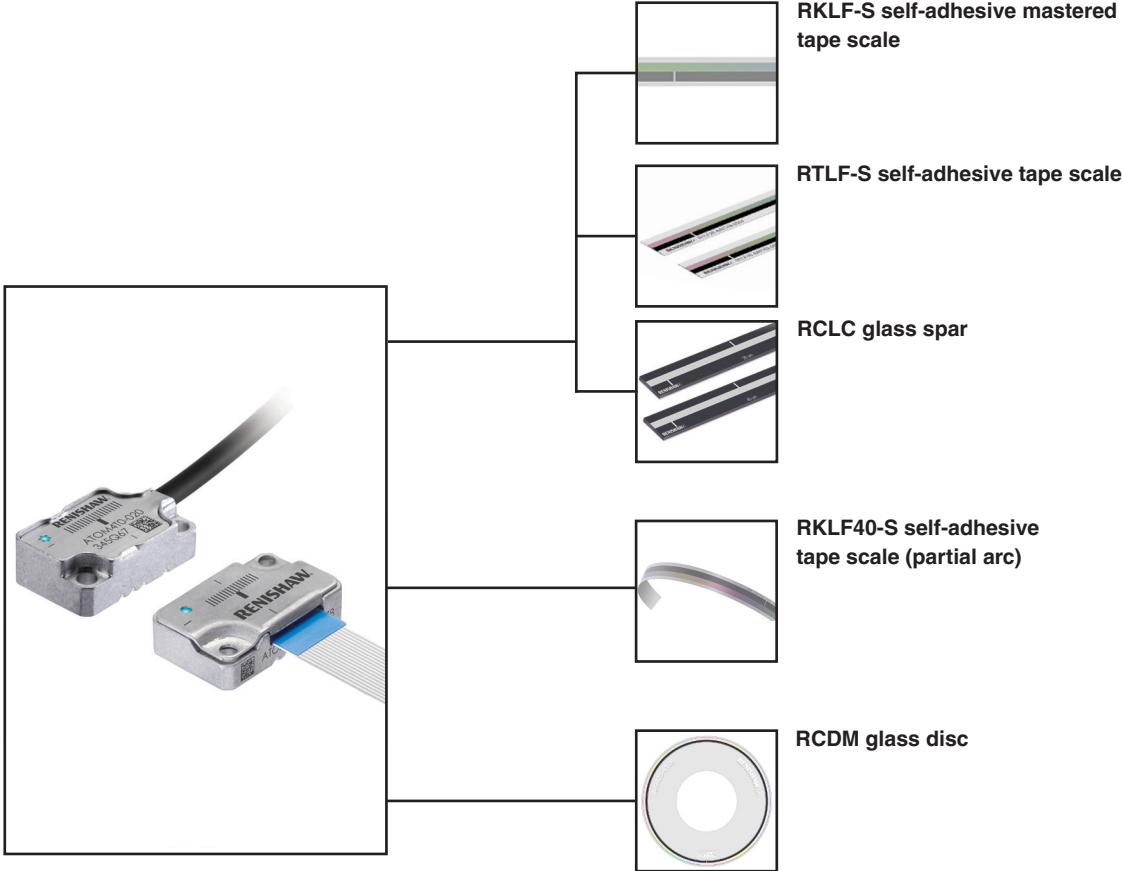

For more information refer to the relevant data sheets and installation guides which can be downloaded from [www.renishaw.com/atomdownloads](http://www.renishaw.com/atomdownloads).

## ATOM compatible interfaces

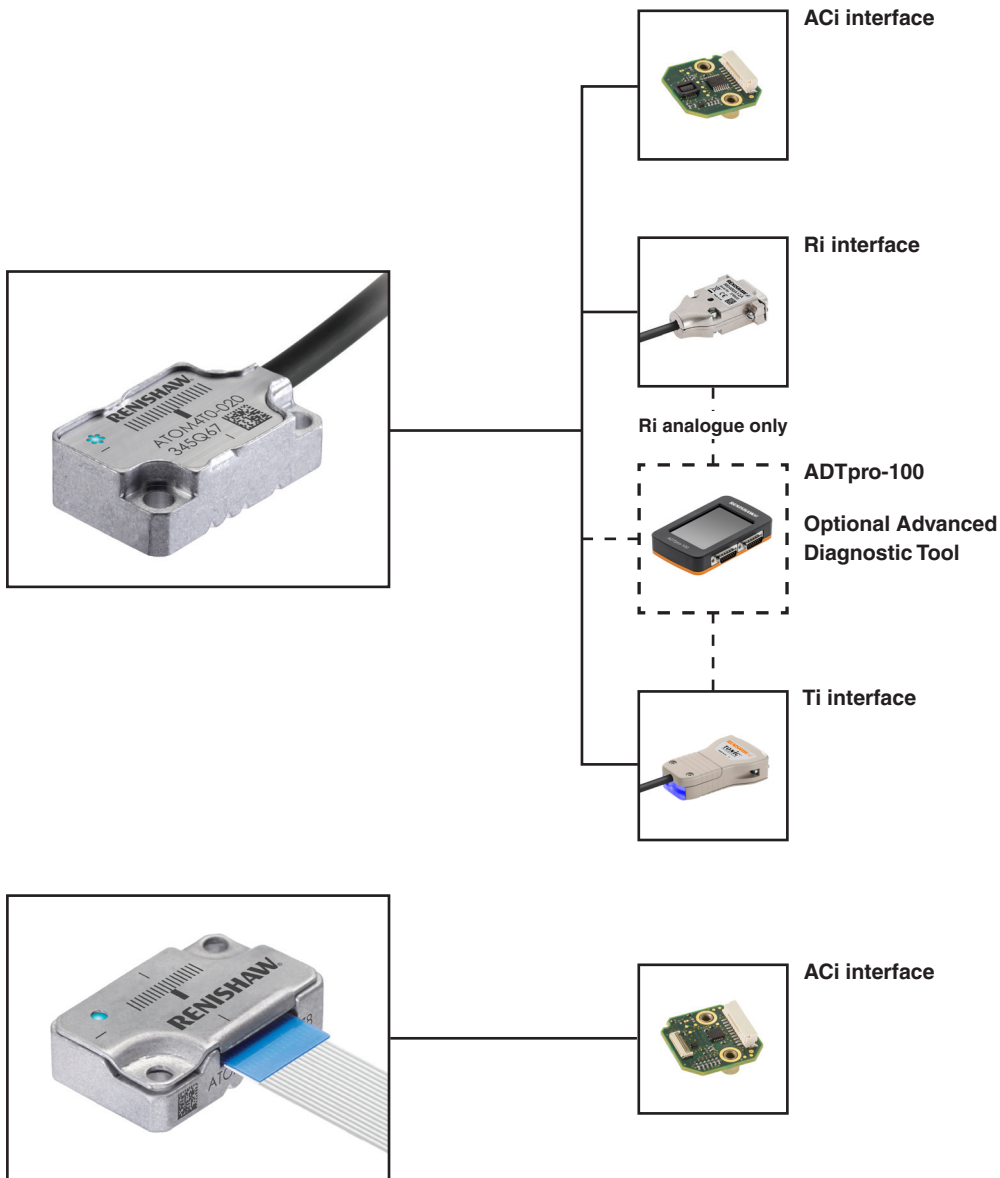

For more information refer to the relevant data sheets and installation guides which can be downloaded from [www.renishaw.com/atomdownloads](http://www.renishaw.com/atomdownloads).

[www.renishaw.com/contact](http://www.renishaw.com/contact)

 #renishaw

 +44 (0) 1453 524524

 [uk@renishaw.com](mailto:uk@renishaw.com)

© 2013–2025 Renishaw plc. All rights reserved. This document may not be copied or reproduced in whole or in part, or transferred to any other media or language by any means, without the prior written permission of Renishaw.  
 RENISHAW® and the probe symbol are registered trade marks of Renishaw plc. Renishaw product names, designations and the mark 'apply innovation' are trade marks of Renishaw plc or its subsidiaries. Loctite® is a registered trade mark of the Henkel Corporation. Other brand, product or company names are trade marks of their respective owners.  
 WHILE CONSIDERABLE EFFORT WAS MADE TO VERIFY THE ACCURACY OF THIS DOCUMENT AT PUBLICATION, ALL WARRANTIES, CONDITIONS, REPRESENTATIONS AND LIABILITY, HOWSOEVER ARISING, ARE EXCLUDED TO THE EXTENT PERMITTED BY LAW.  
 RENISHAW RESERVES THE RIGHT TO MAKE CHANGES TO THIS DOCUMENT AND TO THE EQUIPMENT, AND/OR SOFTWARE AND THE SPECIFICATION DESCRIBED HEREIN WITHOUT OBLIGATION TO PROVIDE NOTICE OF SUCH CHANGES.  
 Renishaw plc. Registered in England and Wales. Company no: 1106260. Registered office: New Mills, Wotton-under-Edge, Glos, GL12 8JR, UK.

Part no.: L-9517-9563-08-A

Issued: 05.2025